



Is Now Part of



**ON Semiconductor®**

To learn more about ON Semiconductor, please visit our website at  
[www.onsemi.com](http://www.onsemi.com)

Please note: As part of the Fairchild Semiconductor integration, some of the Fairchild orderable part numbers will need to change in order to meet ON Semiconductor's system requirements. Since the ON Semiconductor product management systems do not have the ability to manage part nomenclature that utilizes an underscore (\_), the underscore (\_) in the Fairchild part numbers will be changed to a dash (-). This document may contain device numbers with an underscore (\_). Please check the ON Semiconductor website to verify the updated device numbers. The most current and up-to-date ordering information can be found at [www.onsemi.com](http://www.onsemi.com). Please email any questions regarding the system integration to [Fairchild\\_questions@onsemi.com](mailto:Fairchild_questions@onsemi.com).

ON Semiconductor and the ON Semiconductor logo are trademarks of Semiconductor Components Industries, LLC dba ON Semiconductor or its subsidiaries in the United States and/or other countries. ON Semiconductor owns the rights to a number of patents, trademarks, copyrights, trade secrets, and other intellectual property. A listing of ON Semiconductor's product/patent coverage may be accessed at [www.onsemi.com/site/pdf/Patent-Marking.pdf](http://www.onsemi.com/site/pdf/Patent-Marking.pdf). ON Semiconductor reserves the right to make changes without further notice to any products herein. ON Semiconductor makes no warranty, representation or guarantee regarding the suitability of its products for any particular purpose, nor does ON Semiconductor assume any liability arising out of the application or use of any product or circuit, and specifically disclaims any and all liability, including without limitation special, consequential or incidental damages. Buyer is responsible for its products and applications using ON Semiconductor products, including compliance with all laws, regulations and safety requirements or standards, regardless of any support or applications information provided by ON Semiconductor. "Typical" parameters which may be provided in ON Semiconductor data sheets and/or specifications can and do vary in different applications and actual performance may vary over time. All operating parameters, including "Typicals" must be validated for each customer application by customer's technical experts. ON Semiconductor does not convey any license under its patent rights nor the rights of others. ON Semiconductor products are not designed, intended, or authorized for use as a critical component in life support systems or any FDA Class 3 medical devices or medical devices with a same or similar classification in a foreign jurisdiction or any devices intended for implantation in the human body. Should Buyer purchase or use ON Semiconductor products for any such unintended or unauthorized application, Buyer shall indemnify and hold ON Semiconductor and its officers, employees, subsidiaries, affiliates, and distributors harmless against all claims, costs, damages, and expenses, and reasonable attorney fees arising out of, directly or indirectly, any claim of personal injury or death associated with such unintended or unauthorized use, even if such claim alleges that ON Semiconductor was negligent regarding the design or manufacture of the part. ON Semiconductor is an Equal Opportunity/Affirmative Action Employer. This literature is subject to all applicable copyright laws and is not for resale in any manner.

# FDMS3615S

## PowerTrench® Power Stage

### 25V Asymmetric Dual N-Channel MOSFET

#### Features

Q1: N-Channel

- Max  $r_{DS(on)}$  = 5.8 m $\Omega$  at  $V_{GS}$  = 10 V,  $I_D$  = 16 A
- Max  $r_{DS(on)}$  = 8.3 m $\Omega$  at  $V_{GS}$  = 4.5 V,  $I_D$  = 13 A

Q2: N-Channel

- Max  $r_{DS(on)}$  = 3.4 m $\Omega$  at  $V_{GS}$  = 10 V,  $I_D$  = 18 A
- Max  $r_{DS(on)}$  = 4.6 m $\Omega$  at  $V_{GS}$  = 4.5 V,  $I_D$  = 15 A
- Low inductance packaging shortens rise/fall times, resulting in lower switching losses
- MOSFET integration enables optimum layout for lower circuit inductance and reduced switch node ringing
- RoHS Compliant



#### General Description

This device includes two specialized N-Channel MOSFETs in a dual PQFN package. The switch node has been internally connected to enable easy placement and routing of synchronous buck converters. The control MOSFET (Q1) and synchronous SyncFET (Q2) have been designed to provide optimal power efficiency.

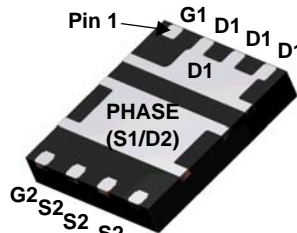
#### Applications

- Computing
- Communications
- General Purpose Point of Load
- Notebook VCORE
- Server

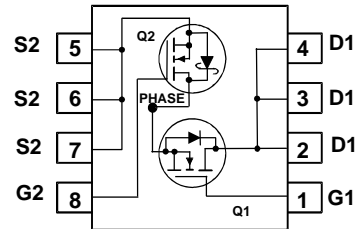


Top

Power 56



Bottom



#### MOSFET Maximum Ratings $T_A = 25^\circ\text{C}$ unless otherwise noted

Symbol	Parameter	Q1	Q2	Units
$V_{DS}$	Drain to Source Voltage	25	25	V
$V_{GS}$	Gate to Source Voltage	(Note 3) $\pm 20$	$\pm 20$	V
$I_D$	Drain Current -Continuous (Package limited)	$T_C = 25^\circ\text{C}$ 23	18	A
	-Continuous (Silicon limited)	$T_C = 25^\circ\text{C}$ 89	88	
	-Continuous	$T_A = 25^\circ\text{C}$ 16 <sup>1a</sup>	18 <sup>1b</sup>	
	-Pulsed	45	36	
$E_{AS}$	Single Pulse Avalanche Energy	38 <sup>4</sup>	98 <sup>5</sup>	mJ
$P_D$	Power Dissipation for Single Operation	$T_A = 25^\circ\text{C}$ 2.3 <sup>1a</sup>	2.3 <sup>1b</sup>	W
	Power Dissipation for Single Operation	$T_A = 25^\circ\text{C}$ 1.0 <sup>1c</sup>	1.0 <sup>1d</sup>	
$T_J, T_{STG}$	Operating and Storage Junction Temperature Range	-55 to +150		$^\circ\text{C}$

#### Thermal Characteristics

$R_{\theta JA}$	Thermal Resistance, Junction to Ambient	55 <sup>1a</sup>	55 <sup>1b</sup>	$^\circ\text{C}/\text{W}$
$R_{\theta JA}$	Thermal Resistance, Junction to Ambient	125 <sup>1c</sup>	125 <sup>1d</sup>	

#### Package Marking and Ordering Information

Device Marking	Device	Package	Reel Size	Tape Width	Quantity
Y80A K100C	FDMS3615S	Power 56	13 "	12 mm	3000 units

**Electrical Characteristics**  $T_J = 25^\circ\text{C}$  unless otherwise noted

Symbol	Parameter	Test Conditions	Type	Min	Typ	Max	Units
--------	-----------	-----------------	------	-----	-----	-----	-------

**Off Characteristics**

$BV_{DSS}$	Drain to Source Breakdown Voltage	$I_D = 250 \mu\text{A}, V_{GS} = 0 \text{ V}$ $I_D = 1 \text{ mA}, V_{GS} = 0 \text{ V}$	Q1 Q2	25 25			V
$\frac{\Delta BV_{DSS}}{\Delta T_J}$	Breakdown Voltage Temperature Coefficient	$I_D = 250 \mu\text{A}$ , referenced to $25^\circ\text{C}$ $I_D = 10 \text{ mA}$ , referenced to $25^\circ\text{C}$	Q1 Q2		18 16		mV/ $^\circ\text{C}$
$I_{DSS}$	Zero Gate Voltage Drain Current	$V_{DS} = 20 \text{ V}, V_{GS} = 0 \text{ V}$	Q1 Q2			1 500	$\mu\text{A}$
$I_{GSS}$	Gate to Source Leakage Current	$V_{GS} = 20 \text{ V}, V_{DS} = 0 \text{ V}$	Q1 Q2			100 100	nA

**On Characteristics**

$V_{GS(th)}$	Gate to Source Threshold Voltage	$V_{GS} = V_{DS}, I_D = 250 \mu\text{A}$ $V_{GS} = V_{DS}, I_D = 1 \text{ mA}$	Q1 Q2	1.2 1.2	1.7 1.8	2.5 2.5	V
$\frac{\Delta V_{GS(th)}}{\Delta T_J}$	Gate to Source Threshold Voltage Temperature Coefficient	$I_D = 250 \mu\text{A}$ , referenced to $25^\circ\text{C}$ $I_D = 10 \text{ mA}$ , referenced to $25^\circ\text{C}$	Q1 Q2		-5 -6		mV/ $^\circ\text{C}$
$r_{DS(on)}$	Static Drain to Source On Resistance	$V_{GS} = 10 \text{ V}, I_D = 16 \text{ A}$ $V_{GS} = 4.5 \text{ V}, I_D = 13 \text{ A}$ $V_{GS} = 10 \text{ V}, I_D = 16 \text{ A}, T_J = 125^\circ\text{C}$	Q1		4.8 6.9 6.6	5.8 8.3 7.9	m $\Omega$
		$V_{GS} = 10 \text{ V}, I_D = 18 \text{ A}$ $V_{GS} = 4.5 \text{ V}, I_D = 15 \text{ A}$ $V_{GS} = 10 \text{ V}, I_D = 18 \text{ A}, T_J = 125^\circ\text{C}$	Q2		2.5 3.6 3.4	3.4 4.6 4.1	
$g_{FS}$	Forward Transconductance	$V_{DD} = 5 \text{ V}, I_D = 16 \text{ A}$ $V_{DD} = 5 \text{ V}, I_D = 18 \text{ A}$	Q1 Q2		63 84		S

**Dynamic Characteristics**

$C_{iss}$	Input Capacitance	Q1: $V_{DS} = 13 \text{ V}, V_{GS} = 0 \text{ V}, f = 1 \text{ MHz}$	Q1 Q2		1326 2175	1765 2895	pF
$C_{oss}$	Output Capacitance	Q2: $V_{DS} = 13 \text{ V}, V_{GS} = 0 \text{ V}, f = 1 \text{ MHz}$	Q1 Q2		342 574	455 765	pF
$C_{riss}$	Reverse Transfer Capacitance	$V_{DS} = 13 \text{ V}, V_{GS} = 0 \text{ V}, f = 1 \text{ MHz}$	Q1 Q2		78 118	115 180	pF
$R_g$	Gate Resistance		Q1 Q2	0.2 0.2	0.9 1.0	2.9 3.2	$\Omega$

**Switching Characteristics**

$t_{d(on)}$	Turn-On Delay Time	Q1 $V_{DD} = 13 \text{ V}, I_D = 16 \text{ A}, R_{GEN} = 6 \Omega$	Q1 Q2		7.7 9.5	15 19	ns
$t_r$	Rise Time		Q1 Q2		1.7 3	10 10	ns
$t_{d(off)}$	Turn-Off Delay Time	Q2 $V_{DD} = 13 \text{ V}, I_D = 18 \text{ A}, R_{GEN} = 6 \Omega$	Q1 Q2		19 24	34 49	ns
$t_f$	Fall Time		Q1 Q2		1.4 2.2	10 10	ns
$Q_{g(TOT)}$	Total Gate Charge	$V_{GS} = 0\text{V to } 10 \text{ V}$	Q1 $V_{DD} = 13 \text{ V},$ $I_D = 16 \text{ A}$	Q1 Q2	19 31	27 43	nC
				$V_{GS} = 0\text{V to } 4.5 \text{ V}$	Q1 Q2	9 14	13 20
$Q_{gs}$	Gate to Source Charge	Q2 $V_{DD} = 13 \text{ V},$ $I_D = 18 \text{ A}$	Q1 Q2		3.6 5.7		nC
$Q_{gd}$	Gate to Drain "Miller" Charge		Q1 Q2		2.4 3.7		nC

## Electrical Characteristics $T_J = 25^\circ\text{C}$ unless otherwise noted

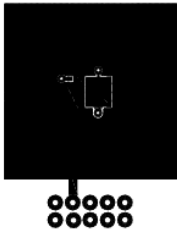
Symbol	Parameter	Test Conditions	Type	Min	Typ	Max	Units
--------	-----------	-----------------	------	-----	-----	-----	-------

### Drain-Source Diode Characteristics

$V_{SD}$	Source-Drain Diode Forward Voltage	$V_{GS} = 0\text{ V}, I_S = 16\text{ A}$ (Note 2)	Q1		0.8	1.2	V
		$V_{GS} = 0\text{ V}, I_S = 18\text{ A}$ (Note 2)	Q2		0.8	1.2	
$t_{rr}$	Reverse Recovery Time	$I_F = 16\text{ A}, di/dt = 100\text{ A/s}$	Q1		19	34	ns
			Q2		24	38	
$Q_{rr}$	Reverse Recovery Charge	$I_F = 18\text{ A}, di/dt = 300\text{ A/s}$	Q1		6	12	nC
			Q2		19	35	

#### Notes:

- $R_{\theta JA}$  is determined with the device mounted on a 1 in<sup>2</sup> pad 2 oz copper pad on a 1.5 x 1.5 in. board of FR-4 material.  $R_{\theta JC}$  is guaranteed by design while  $R_{\theta CA}$  is determined by the user's board design.



a. 55 °C/W when mounted on a 1 in<sup>2</sup> pad of 2 oz copper



b. 55 °C/W when mounted on a 1 in<sup>2</sup> pad of 2 oz copper



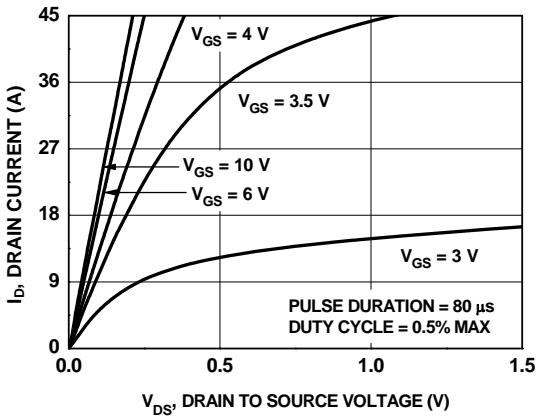
c. 125 °C/W when mounted on a minimum pad of 2 oz copper



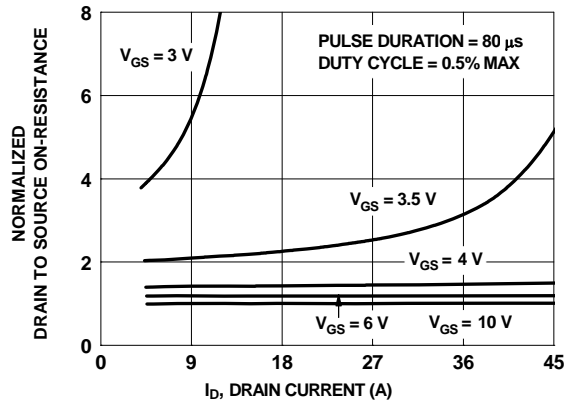
d. 125 °C/W when mounted on a minimum pad of 2 oz copper

- Pulse Test: Pulse Width < 300  $\mu\text{s}$ , Duty cycle < 2.0%.
- As an N-ch device, the negative  $V_{GS}$  rating is for low duty cycle pulse occurrence only. No continuous rating is implied.
- $E_{AS}$  of 38 mJ is based on starting  $T_J = 25^\circ\text{C}$ ; N-ch:  $L = 0.3\text{ mH}$ ,  $I_{AS} = 16\text{ A}$ ,  $V_{DD} = 23\text{ V}$ ,  $V_{GS} = 10\text{ V}$ . 100% test at  $L = 0.3\text{ mH}$ ,  $I_{AS} = 14.6\text{ A}$ .
- $E_{AS}$  of 98 mJ is based on starting  $T_J = 25^\circ\text{C}$ ; N-ch:  $L = 1\text{ mH}$ ,  $I_{AS} = 14\text{ A}$ ,  $V_{DD} = 23\text{ V}$ ,  $V_{GS} = 10\text{ V}$ . 100% test at  $L = 0.3\text{ mH}$ ,  $I_{AS} = 21\text{ A}$ .

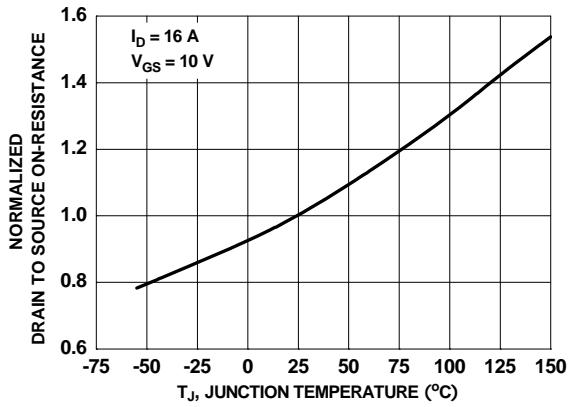
**Typical Characteristics (Q1 N-Channel)**  $T_J = 25^\circ\text{C}$  unless otherwise noted



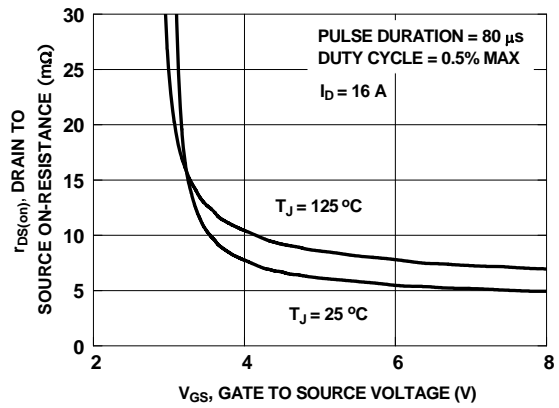
**Figure 1. On Region Characteristics**



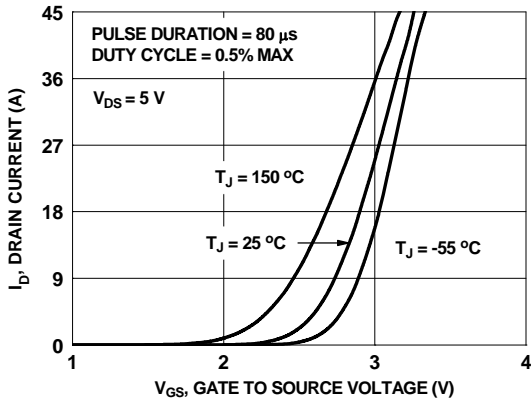
**Figure 2. Normalized On-Resistance vs Drain Current and Gate Voltage**



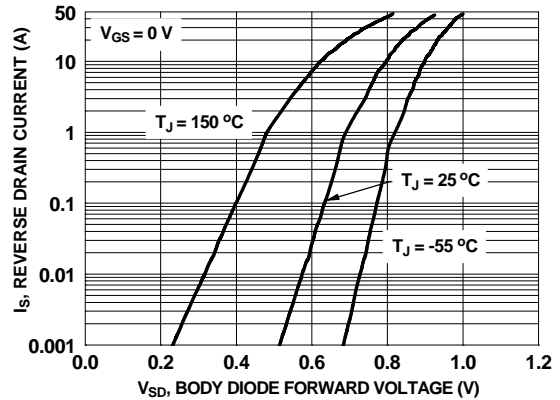
**Figure 3. Normalized On Resistance vs Junction Temperature**



**Figure 4. On-Resistance vs Gate to Source Voltage**

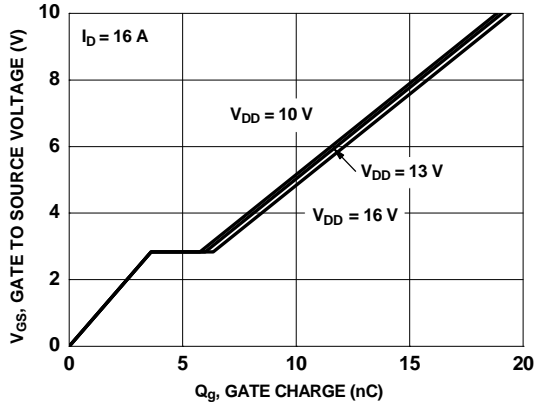


**Figure 5. Transfer Characteristics**

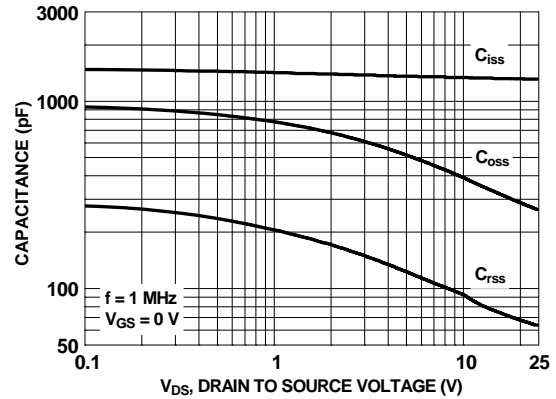


**Figure 6. Source to Drain Diode Forward Voltage vs Source Current**

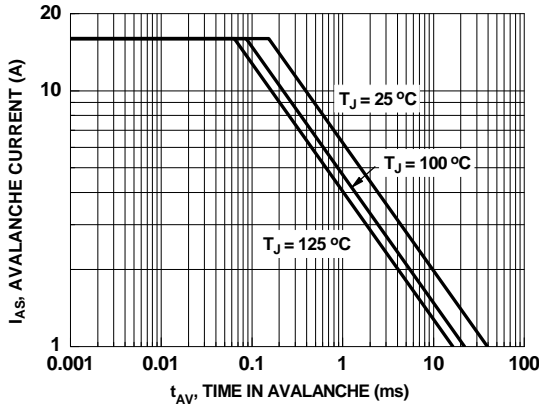
**Typical Characteristics (Q1 N-Channel)**  $T_J = 25^\circ\text{C}$  unless otherwise noted



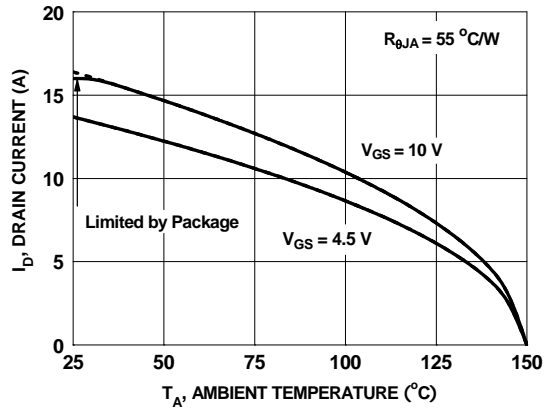
**Figure 7. Gate Charge Characteristics**



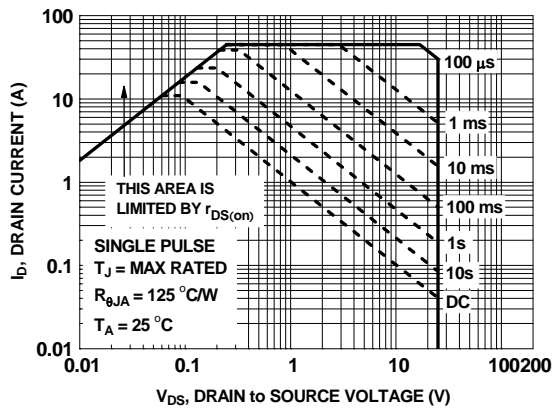
**Figure 8. Capacitance vs Drain to Source Voltage**



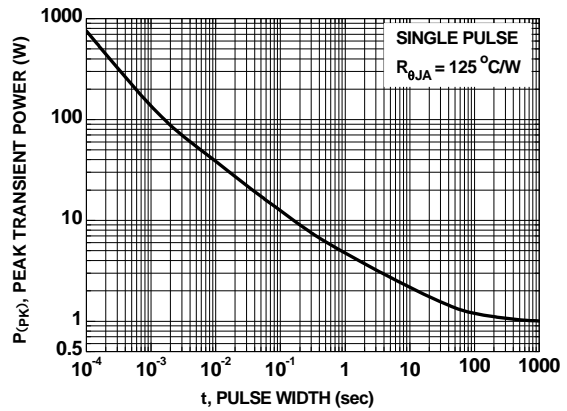
**Figure 9. Unclamped Inductive Switching Capability**



**Figure 10. Maximum Continuous Drain Current vs Ambient Temperature**

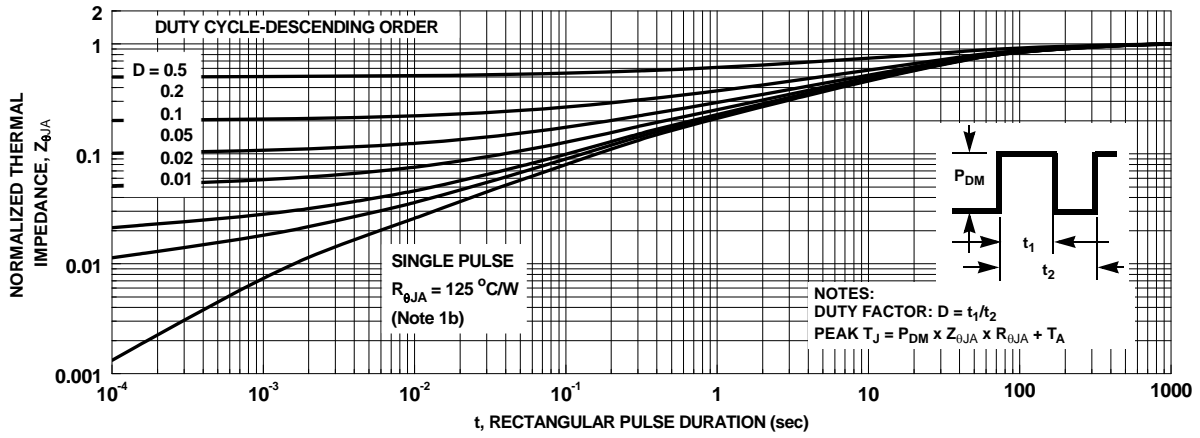


**Figure 11. Forward Bias Safe Operating Area**



**Figure 12. Single Pulse Maximum Power Dissipation**

**Typical Characteristics (Q1 N-Channel)**  $T_J = 25^\circ\text{C}$  unless otherwise noted



**Figure 13. Junction-to-Ambient Transient Thermal Response Curve**

**Typical Characteristics (Q2 N-Channel)**  $T_J = 25\text{ }^\circ\text{C}$  unless otherwise noted

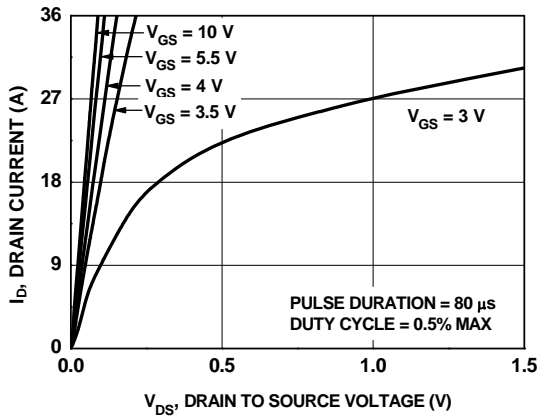


Figure 14. On-Region Characteristics

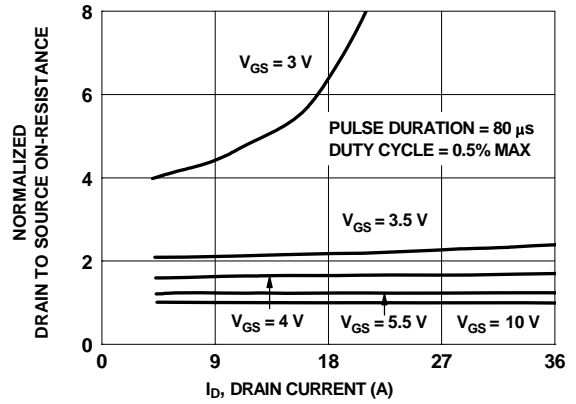


Figure 15. Normalized on-Resistance vs Drain Current and Gate Voltage

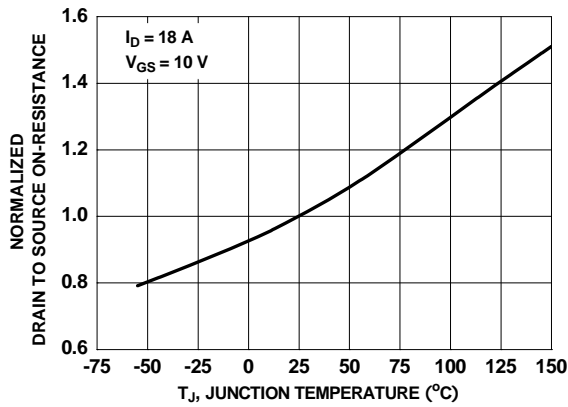


Figure 16. Normalized On-Resistance vs Junction Temperature

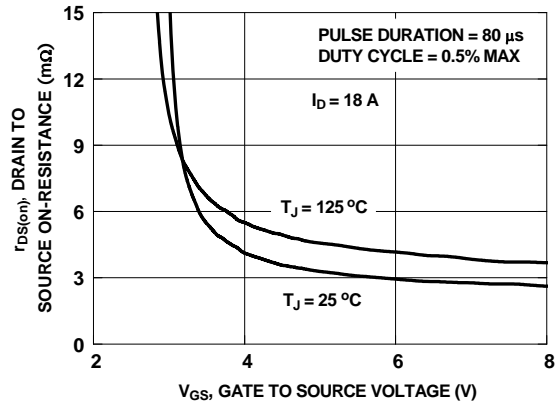


Figure 17. On-Resistance vs Gate to Source Voltage

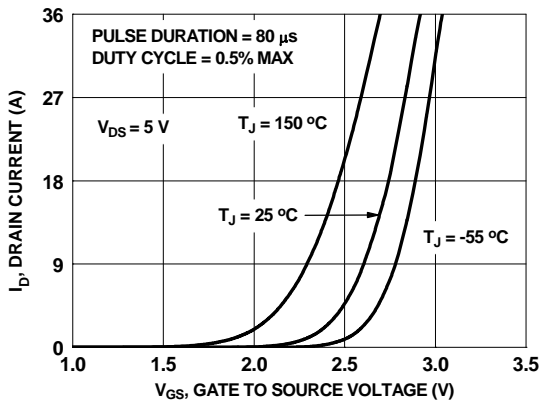


Figure 18. Transfer Characteristics

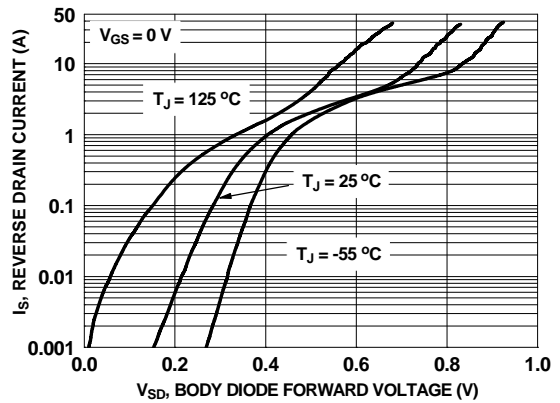
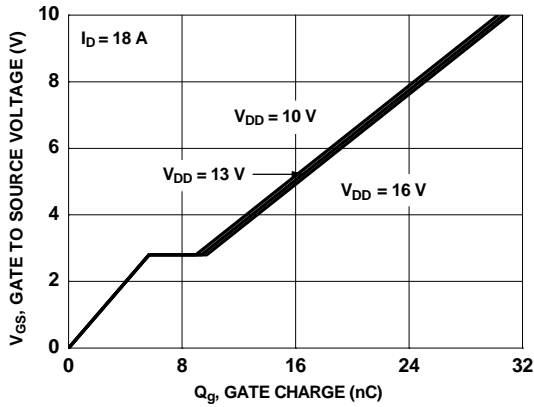


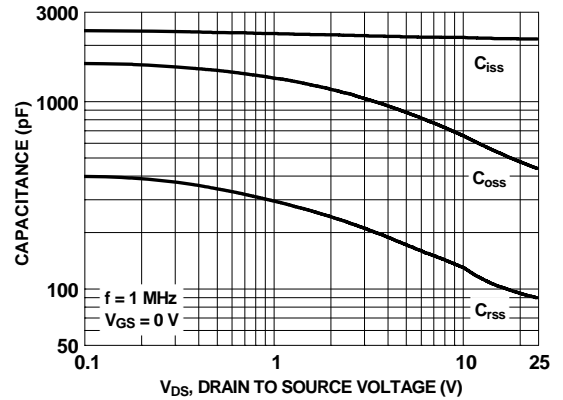
Figure 19. Source to Drain Diode Forward Voltage vs Source Current



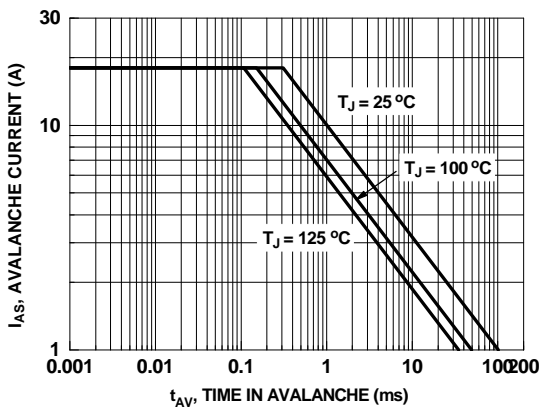
**Typical Characteristics (Q2 N-Channel)**  $T_J = 25^\circ\text{C}$  unless otherwise noted



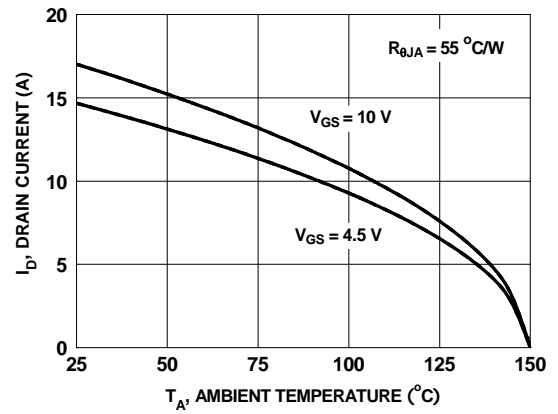
**Figure 20. Gate Charge Characteristics**



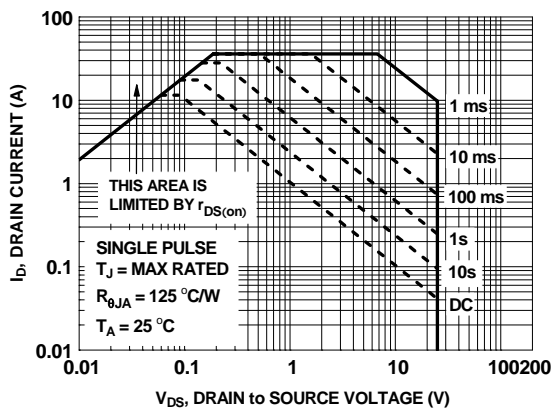
**Figure 21. Capacitance vs Drain to Source Voltage**



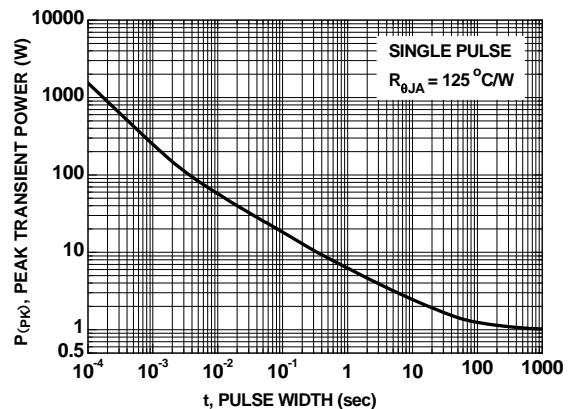
**Figure 22. Unclamped Inductive Switching Capability**



**Figure 23. Maximum Continuous Drain Current vs Ambient Temperature**

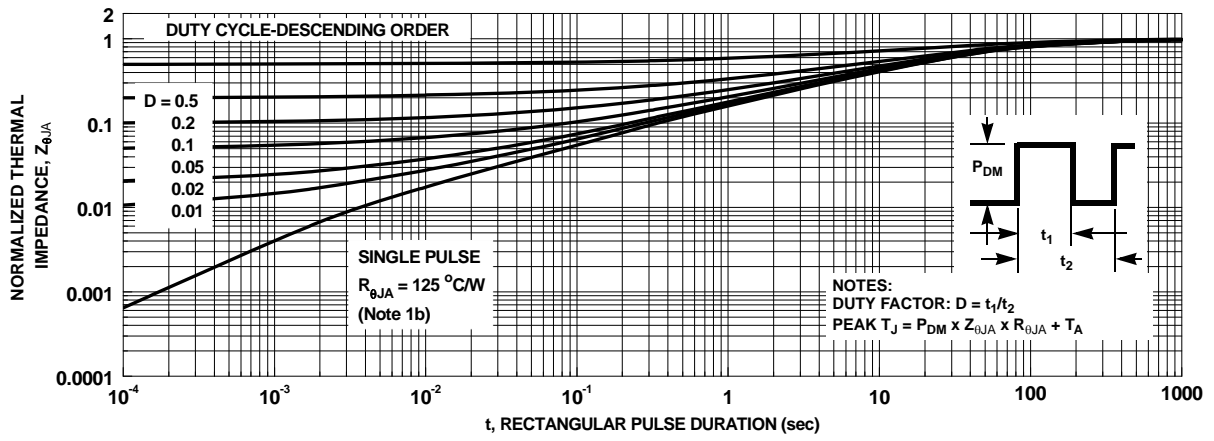


**Figure 24. Forward Bias Safe Operating Area**



**Figure 25. Single Pulse Maximum Power Dissipation**

**Typical Characteristics (Q2 N-Channel)**  $T_J = 25\text{ }^\circ\text{C}$  unless otherwise noted



**Figure 26. Junction-to-Ambient Transient Thermal Response Curve**

## Typical Characteristics (continued)

### SyncFET Schottky body diode Characteristics

Fairchild's SyncFET process embeds a Schottky diode in parallel with PowerTrench MOSFET. This diode exhibits similar characteristics to a discrete external Schottky diode in parallel with a MOSFET. Figure 27 shows the reverse recovery characteristic of the FDMS3615S.

Schottky barrier diodes exhibit significant leakage at high temperature and high reverse voltage. This will increase the power in the device.

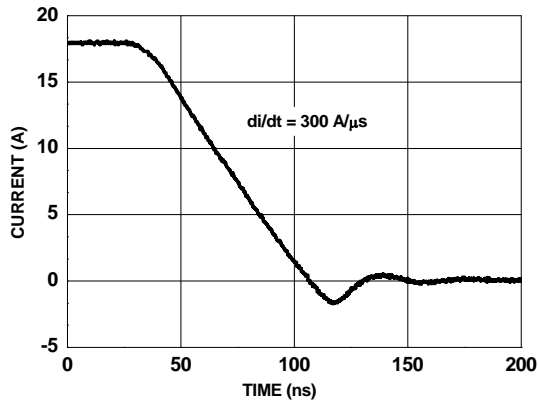


Figure 27. FDMS3615S SyncFET body diode reverse recovery characteristic

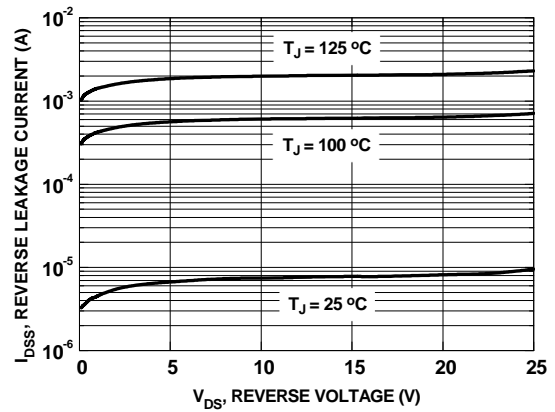
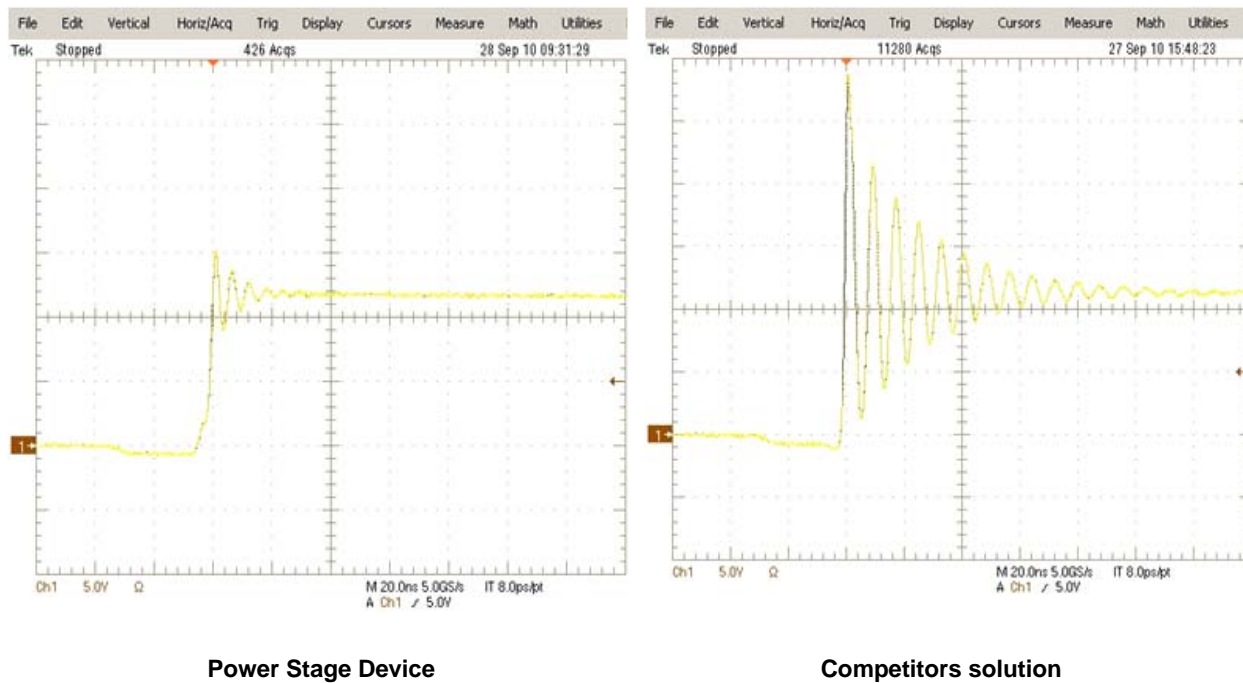


Figure 28. SyncFET body diode reverse leakage versus drain-source voltage

## Application Information

### 1. Switch Node Ringing Suppression

Fairchild's Power Stage products incorporate a proprietary design\* that minimizes the peak overshoot, ringing voltage on the switch node (PHASE) without the need of any external snubbing components in a buck converter. As shown in the figure 29, the Power Stage solution rings significantly less than competitor solutions under the same set of test conditions.



**Figure 29. Power Stage phase node rising edge, High Side Turn on**

\*Patent Pending

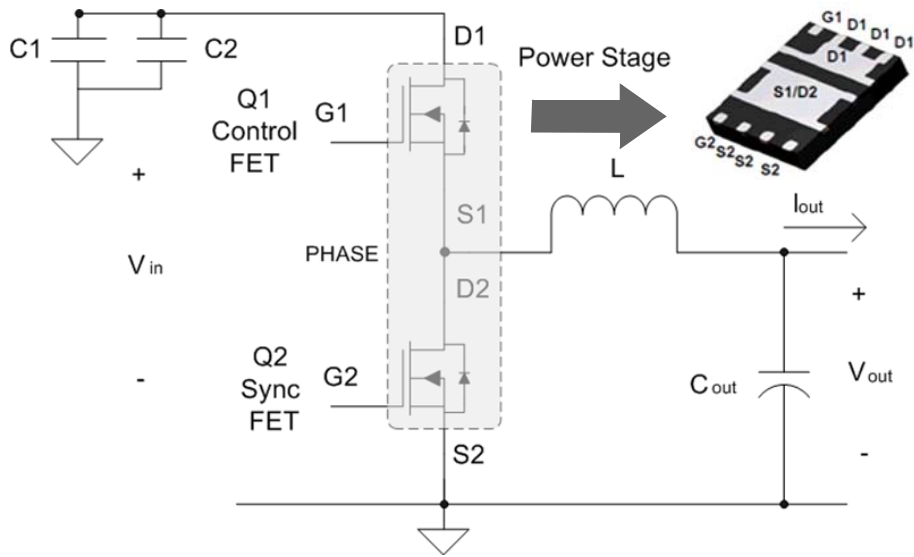


Figure 30. Shows the Power Stage in a buck converter topology

## 2. Recommended PCB Layout Guidelines

As a PCB designer, it is necessary to address critical issues in layout to minimize losses and optimize the performance of the power train. Power Stage is a high power density solution and all high current flow paths, such as VIN (D1), PHASE (S1/D2) and GND (S2), should be short and wide for better and stable current flow, heat radiation and system performance. A recommended layout procedure is discussed below to maximize the electrical and thermal performance of the part.

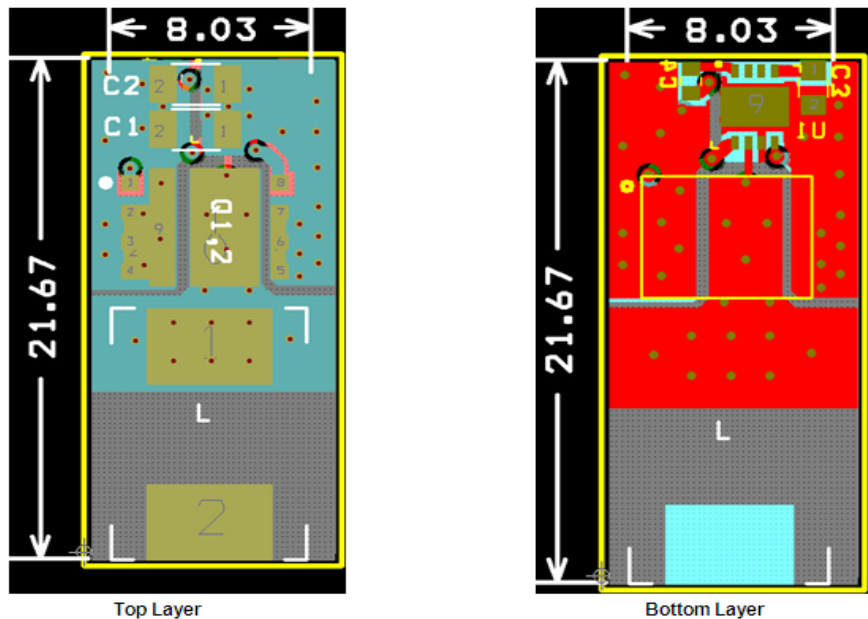
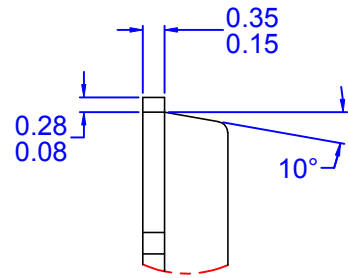
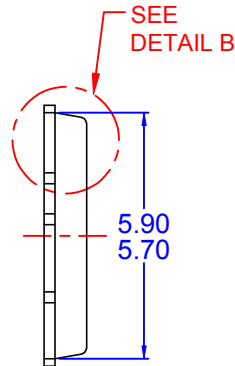
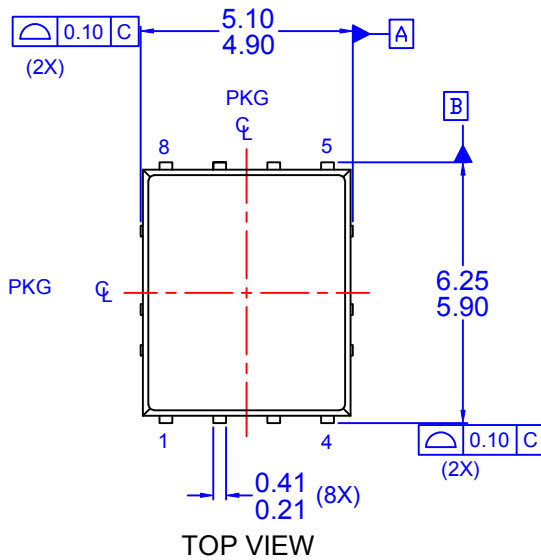


Figure 31. Recommended PCB Layout

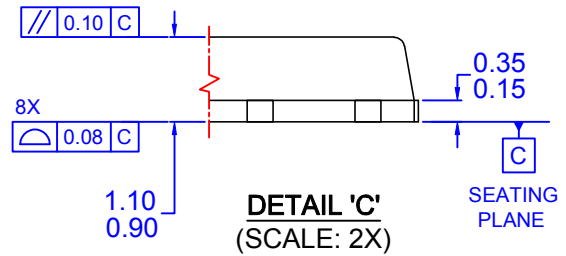
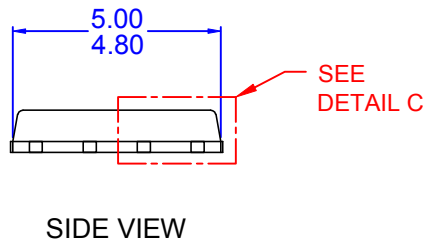
**Following is a guideline, not a requirement which the PCB designer should consider:**

1. Input ceramic bypass capacitors C1 and C2 must be placed close to the D1 and S2 pins of Power Stage to help reduce parasitic inductance and High Frequency conduction loss induced by switching operation. C1 and C2 show the bypass capacitors placed close to the part between D1 and S2. Input capacitors should be connected in parallel close to the part. Multiple input caps can be connected depending upon the application.
2. The PHASE copper trace serves two purposes; In addition to being the current path from the Power Stage package to the output inductor (L), it also serves as heat sink for the lower FET in the Power Stage package. The trace should be short and wide enough to present a low resistance path for the high current flow between the Power Stage and the inductor. This is done to minimize conduction losses and limit temperature rise. Please note that the PHASE node is a high voltage and high frequency switching node with high noise potential. Care should be taken to minimize coupling to adjacent traces. The reference layout in figure 31 shows a good balance between the thermal and electrical performance of Power Stage.
3. Output inductor location should be as close as possible to the Power Stage device for lower power loss due to copper trace resistance. A shorter and wider PHASE trace to the inductor reduces the conduction loss. Preferably the Power Stage should be directly in line (as shown in figure 31) with the inductor for space savings and compactness.
4. The PowerTrench® Technology MOSFETs used in the Power Stage are effective at minimizing phase node ringing. It allows the part to operate well within the breakdown voltage limits. This eliminates the need to have an external snubber circuit in most cases. If the designer chooses to use an RC snubber, it should be placed close to the part between the PHASE pad and S2 pins to dampen the high-frequency ringing.
5. The driver IC should be placed close to the Power Stage part with the shortest possible paths for the High Side gate and Low Side gates through a wide trace connection. This eliminates the effect of parasitic inductance and resistance between the driver and the MOSFET and turns the devices on and off as efficiently as possible. At higher-frequency operation this impedance can limit the gate current trying to charge the MOSFET input capacitance. This will result in slower rise and fall times and additional switching losses. Power Stage has both the gate pins on the same side of the package which allows for back mounting of the driver IC to the board. This provides a very compact path for the drive signals and improves efficiency of the part.
6. S2 pins should be connected to the GND plane with multiple vias for a low impedance grounding. Poor grounding can create a noise transient offset voltage level between S2 and driver ground. This could lead to faulty operation of the gate driver and MOSFET.
7. Use multiple vias on each copper area to interconnect top, inner and bottom layers to help smooth current flow and heat conduction. Vias should be relatively large, around 8 mils to 10 mils, and of reasonable inductance. Critical high frequency components such as ceramic bypass caps should be located close to the part and on the same side of the PCB. If not feasible, they should be connected from the backside via a network of low inductance vias.

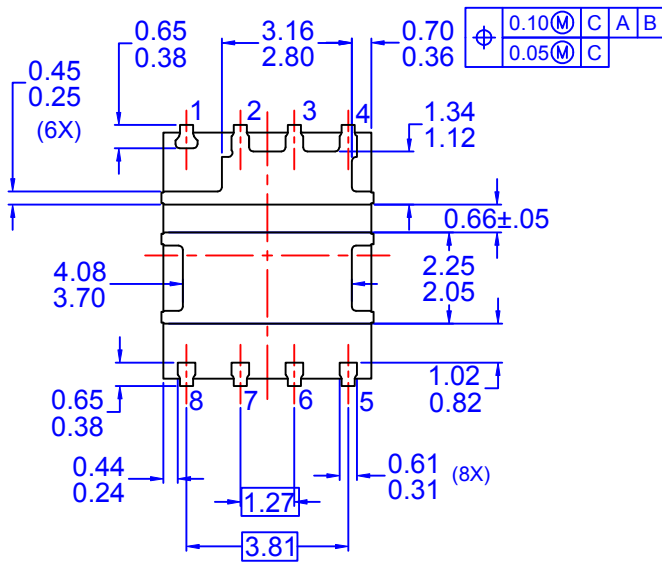




**DETAIL 'B'**  
(SCALE: 2X)



**DETAIL 'C'**  
(SCALE: 2X)



**BOTTOM VIEW**  
**OPTION - B (PUNCHED TYPE)**

- NOTES: UNLESS OTHERWISE SPECIFIED
- A) PACKAGE STANDARD REFERENCE: JEDEC REGISTRATION, MO-240, VARIATION AA.
  - B) ALL DIMENSIONS ARE IN MILLIMETERS.
  - C) DIMENSIONS DO NOT INCLUDE BURRS OR MOLD FLASH. MOLD FLASH OR BURRS DOES NOT EXCEED 0.10MM.
  - D) DIMENSIONING AND TOLERANCING PER ASME Y14.5M-1994.
  - E) IT IS RECOMMENDED TO HAVE NO TRACES OR VIAS WITHIN THE KEEP OUT AREA.
  - F) DRAWING FILE NAME: PQFN08EREV6.
  - G) FAIRCHILD SEMICONDUCTOR



ON Semiconductor and  are trademarks of Semiconductor Components Industries, LLC dba ON Semiconductor or its subsidiaries in the United States and/or other countries. ON Semiconductor owns the rights to a number of patents, trademarks, copyrights, trade secrets, and other intellectual property. A listing of ON Semiconductor's product/patent coverage may be accessed at [www.onsemi.com/site/pdf/Patent-Marking.pdf](http://www.onsemi.com/site/pdf/Patent-Marking.pdf). ON Semiconductor reserves the right to make changes without further notice to any products herein. ON Semiconductor makes no warranty, representation or guarantee regarding the suitability of its products for any particular purpose, nor does ON Semiconductor assume any liability arising out of the application or use of any product or circuit, and specifically disclaims any and all liability, including without limitation special, consequential or incidental damages. Buyer is responsible for its products and applications using ON Semiconductor products, including compliance with all laws, regulations and safety requirements or standards, regardless of any support or applications information provided by ON Semiconductor. "Typical" parameters which may be provided in ON Semiconductor data sheets and/or specifications can and do vary in different applications and actual performance may vary over time. All operating parameters, including "Typicals" must be validated for each customer application by customer's technical experts. ON Semiconductor does not convey any license under its patent rights nor the rights of others. ON Semiconductor products are not designed, intended, or authorized for use as a critical component in life support systems or any FDA Class 3 medical devices or medical devices with a same or similar classification in a foreign jurisdiction or any devices intended for implantation in the human body. Should Buyer purchase or use ON Semiconductor products for any such unintended or unauthorized application, Buyer shall indemnify and hold ON Semiconductor and its officers, employees, subsidiaries, affiliates, and distributors harmless against all claims, costs, damages, and expenses, and reasonable attorney fees arising out of, directly or indirectly, any claim of personal injury or death associated with such unintended or unauthorized use, even if such claim alleges that ON Semiconductor was negligent regarding the design or manufacture of the part. ON Semiconductor is an Equal Opportunity/Affirmative Action Employer. This literature is subject to all applicable copyright laws and is not for resale in any manner.

## PUBLICATION ORDERING INFORMATION

### LITERATURE FULFILLMENT:

Literature Distribution Center for ON Semiconductor  
19521 E. 32nd Pkwy, Aurora, Colorado 80011 USA  
**Phone:** 303-675-2175 or 800-344-3860 Toll Free USA/Canada  
**Fax:** 303-675-2176 or 800-344-3867 Toll Free USA/Canada  
**Email:** [orderlit@onsemi.com](mailto:orderlit@onsemi.com)

**N. American Technical Support:** 800-282-9855 Toll Free  
USA/Canada  
**Europe, Middle East and Africa Technical Support:**  
Phone: 421 33 790 2910  
**Japan Customer Focus Center**  
Phone: 81-3-5817-1050

**ON Semiconductor Website:** [www.onsemi.com](http://www.onsemi.com)  
**Order Literature:** <http://www.onsemi.com/orderlit>  
For additional information, please contact your local  
Sales Representative