

Programmable Controllers

CS1D Duplex System

Redundant CPU Units, Power Supply Units, Communications Units, and Expansion I/O Cables



- » Select from a Wide Range of Redundant Systems
- » Easily Achieve Highly Reliable Systems

Failures occur in any system, but the effects of those failures can be alleviated.

- The system cannot be stopped during 24-h/day operation.
- Recovery costs are very high if the system goes down.
- If the system stops unexpectedly, there is a possibility for a disastrous incident, such as the leakage of a toxic substance.

In systems like these that demand high reliability, it is important to implement risk-management to prepare for hypothetical problems.

OMRON Duplex PLCs are used for risk management in the system.

Adding redundancy in the system is an effective step to reduce risk.

To respond to customer's needs regarding system reliability, OMRON applied its proven duplex PLC technology to the CS Series to provide a highly reliable PLC System.

These PLC Systems have redundant vital components (such as CPUs, power supplies, networks, and expansion cables), while retaining the CS1-series functions and capabilities that are suitable for a wide variety of applications.

I N D E X

■ Types of Duplex Systems.....	4
■ Network Configuration.....	6
■ Introduction/Operation.....	8
■ Dual I/O Expansion System.....	10
■ PLC-based Process Control System.....	12
■ System Configuration.....	16
SYSTEM1.....	16
SYSTEM2.....	20
SYSTEM3.....	26
■ Dimensions	31
■ General Specifications.....	32
■ CPU Units.....	33
■ Common Specifications.....	34
■ Function Added by Unit Version.....	36
■ Ordering Information.....	37



Programmable Controllers

CS1D

DUPLX SYSTEM

With the CS1D, you can select

In addition to duplexed CPU Units and Power Supply Units, the customer can duplex other components, such as Communications Units (Controller Link or Ethernet) and Expansion Cables, to match the system requirements and provide a diverse range of duplex system configurations.

System name					
Configuration					
Duplex	CPU Units				
	Expansion Cables				
	Power Supply Units				
Online operation	<table border="1"> <tr> <td>Communications Units</td> <td>Controller Link</td> </tr> <tr> <td></td> <td>Ethernet</td> </tr> </table>	Communications Units	Controller Link		Ethernet
	Communications Units	Controller Link			
	Ethernet				
	Unit replacement				
	Adding Units or Backplanes				
Long-distance Expansion System					
Amount of I/O memory shared between CPU Units					
Switching time	CPU Unit				
	Communications Unit (reference value)				
Details					

SYSTEM 1 Duplex CPU, Dual I/O Expansion System

The entire system can be duplexed, including a Duplex CPU System, Expansion System, and Expansion Cables, for superior redundancy and maintainability.

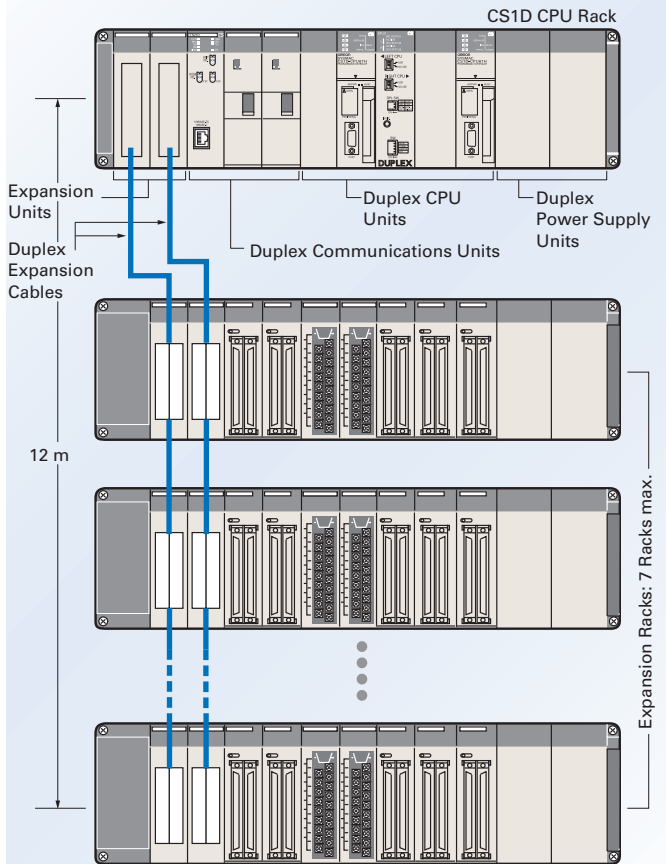

Note: Requires CS1D CPU Units with unit version 1.3 or later.

<input type="radio"/>	
<input type="radio"/>	
<input type="radio"/>	
<input type="radio"/>	(Supports optical loop-back.)
<input type="radio"/>	
<input checked="" type="radio"/>	<ul style="list-style-type: none"> •CPU Units •Power Supply Units •Duplex Units •I/O Expansion Units •Basic I/O Units (can be replaced without a Programming Device) •Special I/O Units (can be replaced without a Programming Device) •CPU Bus Units (can be replaced without a Programming Device)
<input type="radio"/>	<ul style="list-style-type: none"> •Basic I/O Units •Special I/O Units •Expansion Backplanes
<input checked="" type="radio"/>	
	All of the CPU Unit's data areas (shared real-time)
	Within one CPU Unit cycle (within 0.5 ms min.) (See note 1.)
	Within approx. 900 ms (See note 2.)
Page 16	

Note 1: Depends upon the timing when the CPU Units are switched.

Note 2: This value is for Duplex Controller Link Units. The value depends on the timing when the Units are switched.

from a variety of redundant systems.

SYSTEM 2 Duplex CPU, Single I/O Expansion System

The main system components (such as the CPU Units, Power Supply Units, and Communications Units) can be duplexed and a Programming Device can be used to replace the Units during operation. This system is equivalent to the previous Duplex CPU System.

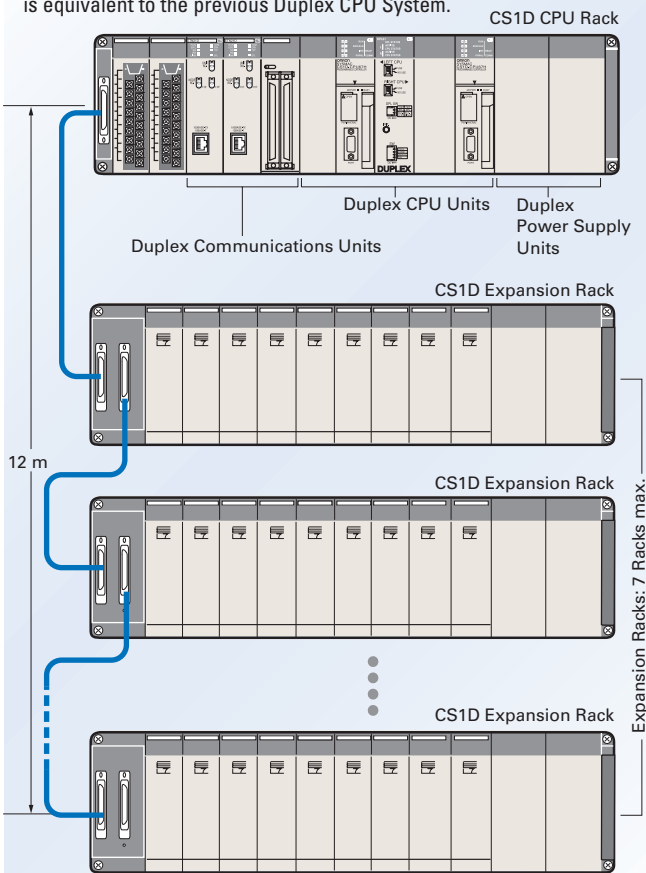

<input type="radio"/>
<input checked="" type="checkbox"/>
<input type="radio"/>
<input type="radio"/> (Supports optical loop-back.)
<input type="radio"/>
<input type="radio"/>
•CPU Units •Power Supply Units •Basic I/O Units (See note.) •Special I/O Units (See note.) •CPU Bus Units (See note.) Note: A Programming Device is required to replace these Units.
<input type="radio"/> (Requires CS1D CPU Units with unit version 1.3 or later.)
•Basic I/O Units •Special I/O Units (See note 3.)
<input type="radio"/>
All of the CPU Unit's data areas (shared real-time)
Within one CPU Unit cycle (within 0.5 ms min.) (See note 1.)
Within approx. 900 ms (See note 2.)
Page 20

SYSTEM 3 Single-CPU System

This system is ideal when you want to improve network redundancy and replace a Power Supply Unit or other Units online. The CPU Unit cannot be duplexed.

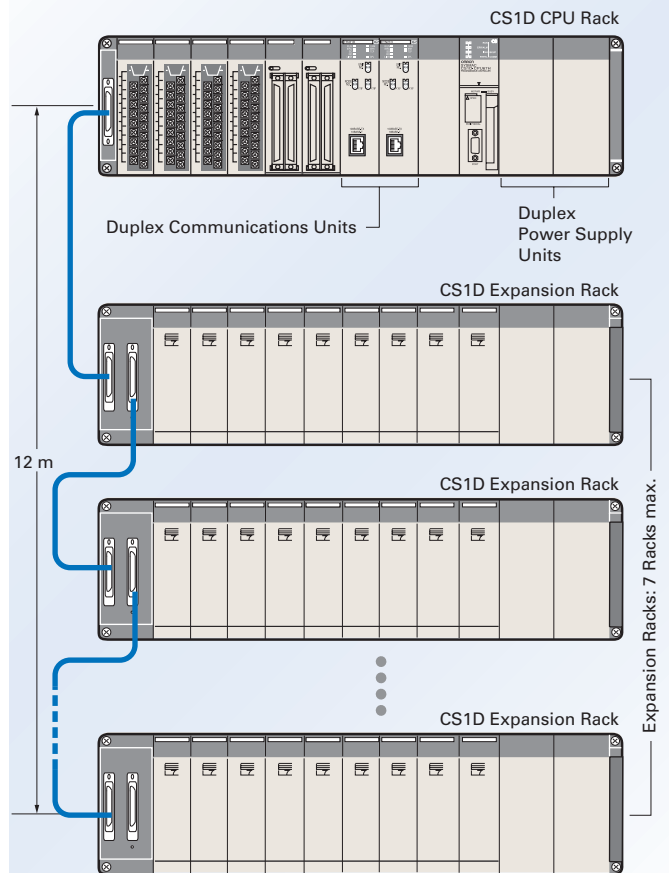

<input checked="" type="checkbox"/>
<input checked="" type="checkbox"/>
<input type="radio"/>
<input type="radio"/> (Supports optical loop-back.)
<input type="radio"/>
<input type="radio"/>
•Power Supply Units •Basic I/O Units (See note.) •Special I/O Units (See note.) •CPU Bus Units (See note.) Note: A Programming Device is required to replace these Units.
<input checked="" type="checkbox"/>
<input type="checkbox"/>
<input type="radio"/>
<input type="checkbox"/>
Within approx. 900 ms (See note 2.)
Page 26

Note 3: Expansion Backplanes cannot be added.

The CS1D supports a variety of

Ethernet can be duplexed as well as Controller Link, which both have a proven track record in FA applications.

In addition, a variety of networks are available for lower-level I/O, including DeviceNet, CompoNet, and the MECHATROLINK-II Motion Controller network. Both DeviceNet and CompoNet are open networks that boast a proven track record with the CS1 Series.

Ethernet



Ethernet is a general-purpose network used globally in a wide range of factory and office environments. Supports message service between PLCs or between a computer and PLC. In a duplex system, transmission paths can be set as primary and secondary paths, and Communications Units can be duplexed as well.

Ethernet Primary Network

Secondary Network

By duplexing Communications Units, communications will continue even if one Unit fails.

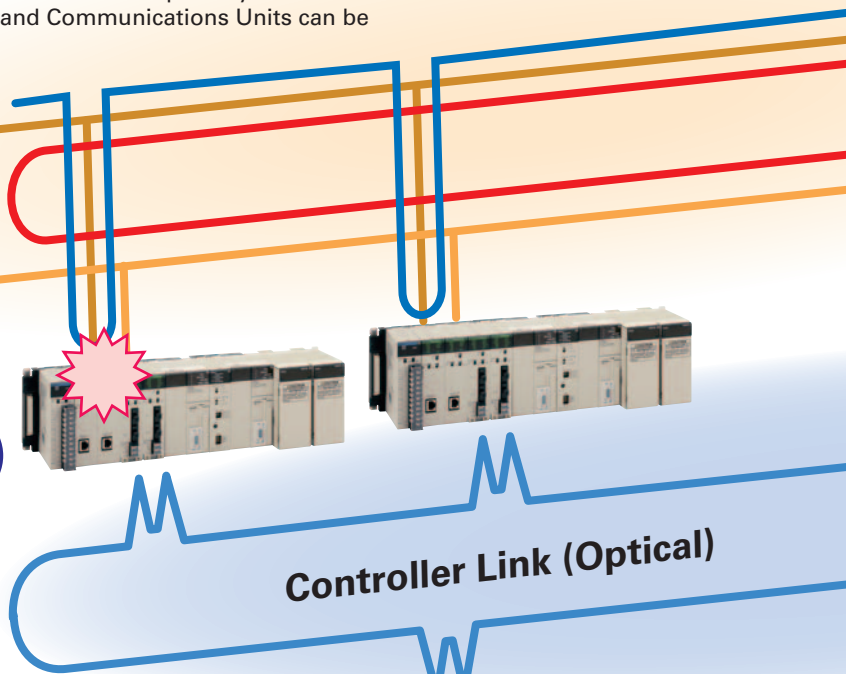

Controller Link (Optical)

Multi-vendor Network for Sensors and Actuators

CompoNet

CompoNet is a multi-vendor compatible network that can provide excellent bit-level control of 1,000 I/O points in about 1.0 ms. CompoNet supports message communications as well as sensor and actuator-level control. The maintenance information in each slave can be managed to use for preventive maintenance of the equipment.

Information useful for equipment maintenance can be collected.

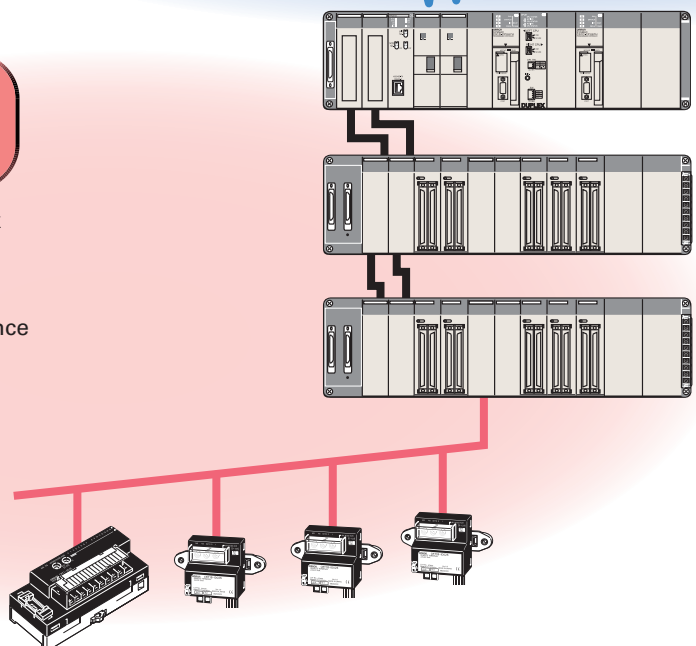

network configurations.

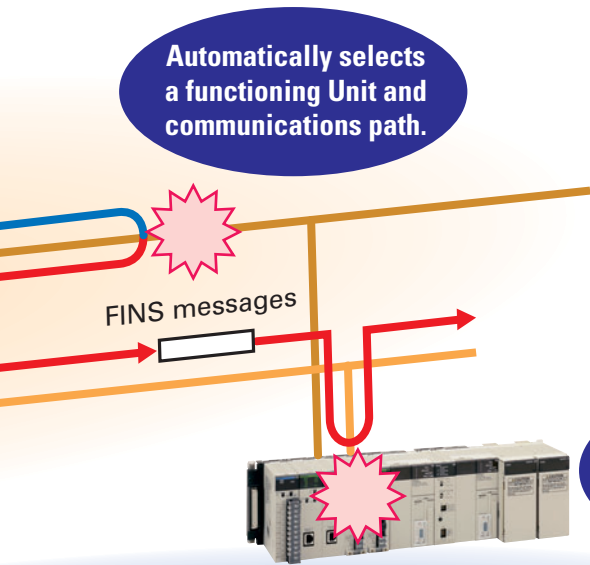

OMRON PLC Network Controller Link

A Controller Link network supports high-volume data links and message service between PLCs and between computers and PLCs. In a duplex system, redundancy can be added by duplexing Communications Units and using optical cable loop-back.

Communications continue even if an error occurs in one of the Communications Units.

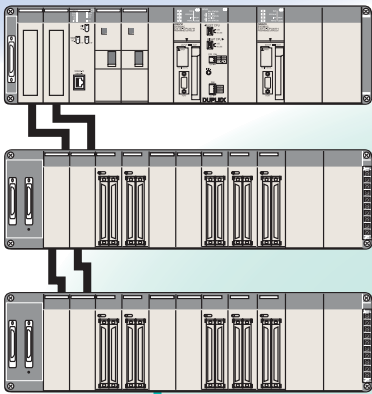
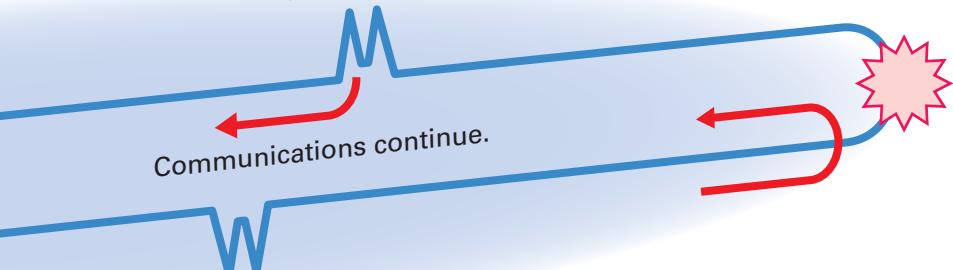

Open Multi-vendor Network DeviceNet

DeviceNet is a multi-vendor network. DeviceNet features superb environmental resistance and is used in all kinds of processes in the FA environment. The maintenance information in each slave can be managed and accessed from the host through message service.

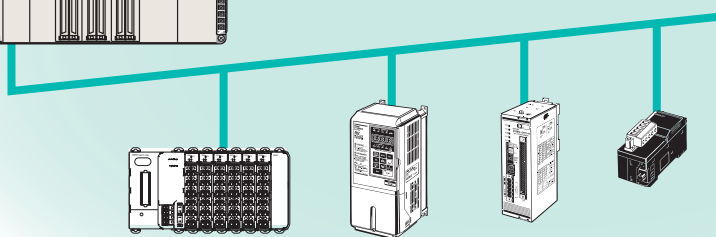

Information useful for equipment maintenance can be collected.

With the CS1D, a highly reliable

Of course, the standard CS-series PLC resources can be used as-is, and a CS1D Duplex System can be set up and used easily, even by users setting up a duplex system for the first time.

Duplexing CPU Units is Easy!

In OMRON's proprietary hot-standby method, all data is shared simultaneously.

- If an error occurs in the active CPU Unit, a switching program is not needed in the standby CPU Unit!
- CPU Unit operation switches smoothly. Switching time is short, so operation can continue without bumps.

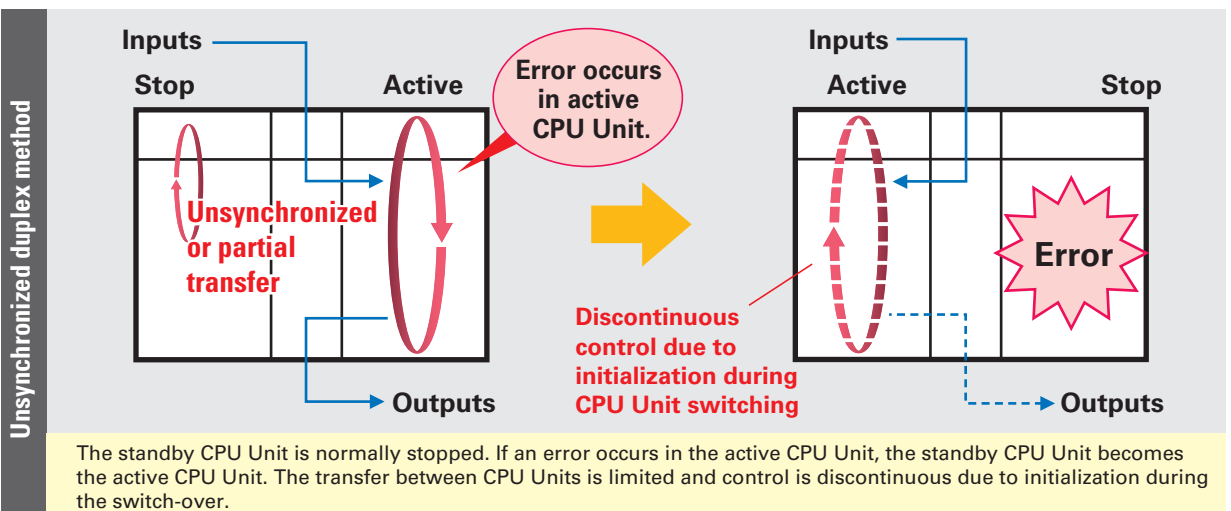
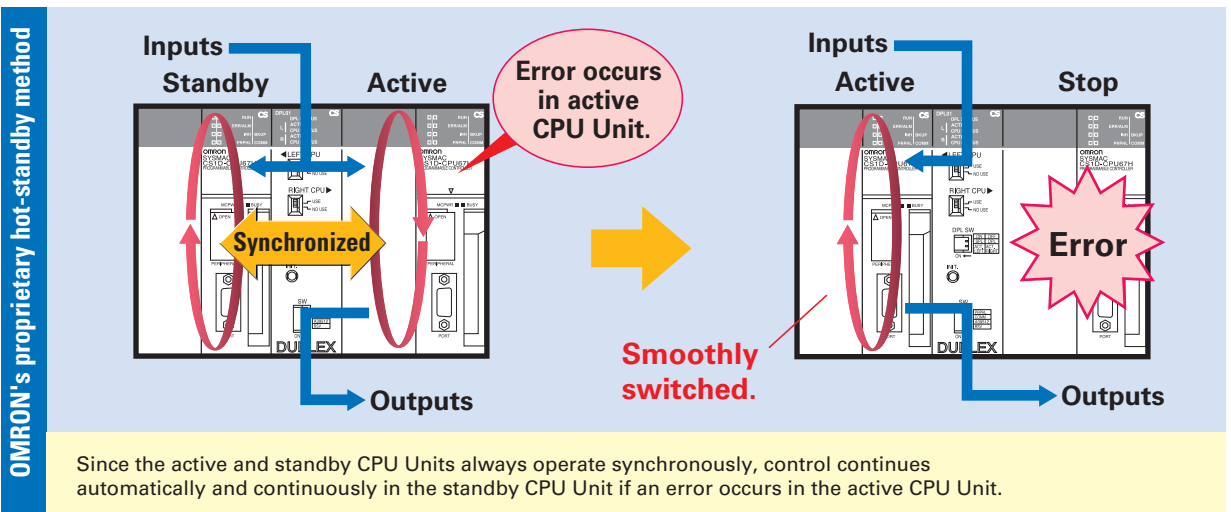
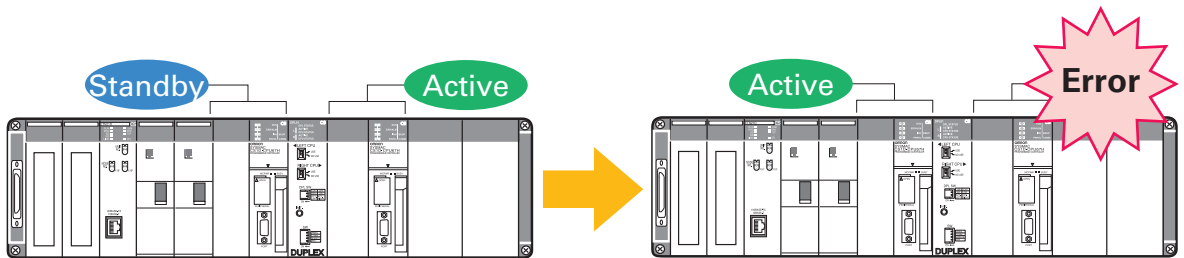

system can be introduced easily.

Duplexing Communications Units is Easy!

The CPU Unit automatically selects the normally functioning Communications Unit.

- When an error occurs, it is not necessary to use a complex switching program or special data link area for duplexing!

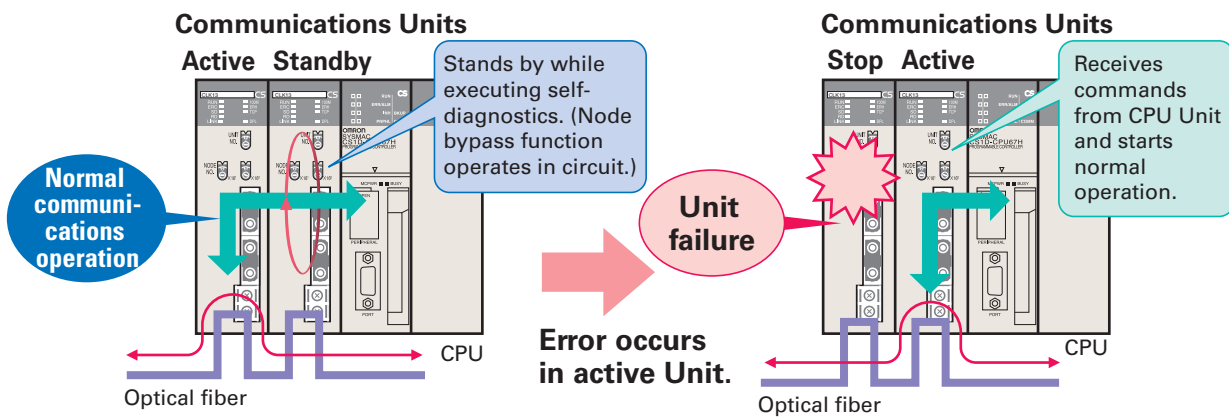

Note : The figure shows duplexing Controller Link Units. For details on wiring optical fiber cables, refer to the CS1W-CLK12-V1/CLK13/CLK52-V1/CLK53, CVM1-CLK12/CLK52 Optical Ring Controller Link Units Operation Manual (Cat. No. W370)

When Ethernet Units are used, complex switching programs for message communications can be simplified.

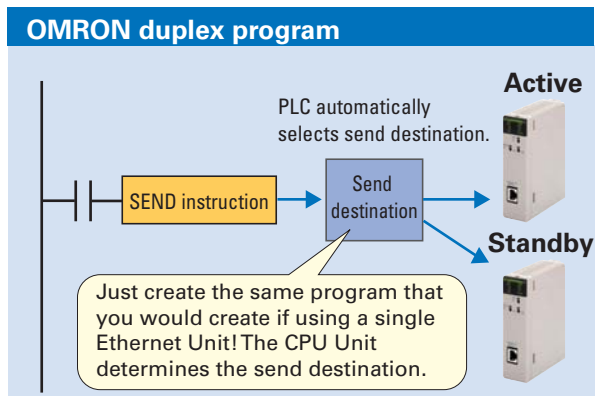
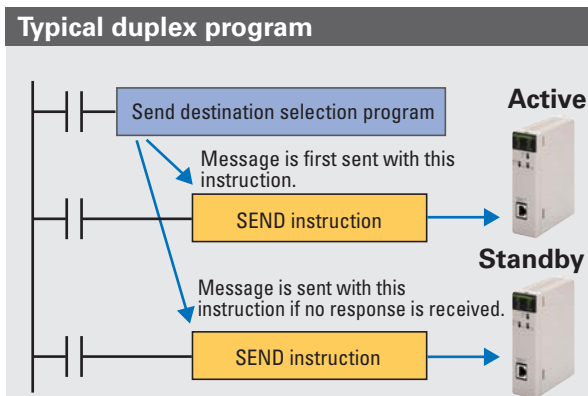

When using a Controller Link Unit, data link area allocations can be configured without waste.

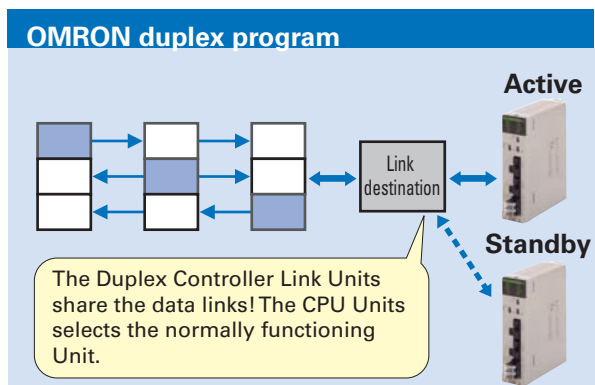
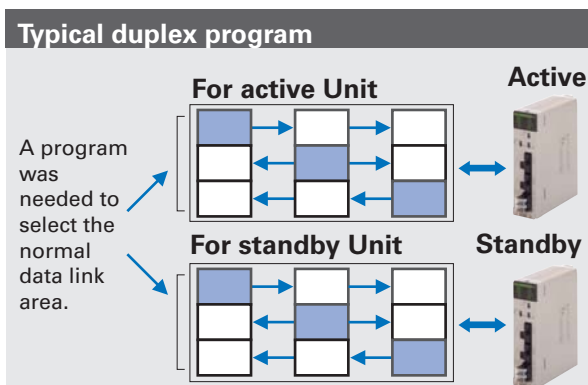

New Release! The Ultimate

The newly released Duplex CPU, Dual I/O Expansion system draws attention in the maintenance field! This system answers the needs of users who want to make improvements and add functions without stopping the equipment. This strengthens the proven CS1D Duplex System even more.

The functions in this section are supported only in a Duplex CPU, Dual I/O Expansion System.

Equipped with New Functions for Maintenance!

Special Programming Devices and Displays are not required for Online Unit Replacement.

- A computer is not needed for onsite operations!
- Units can be replaced without knowing Programming Device procedures!

Power is ON and the PLC is operating.

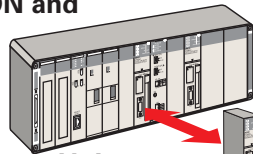

Unit replacement

Can be removed directly.

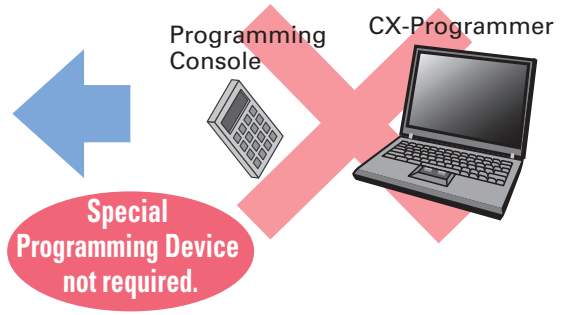

Units and Expansion Backplanes can be added online.

- Functions can be added easily after the system has started operating, even if the system cannot be turned OFF or stopped.
- Adjustments and improvements can be easily made when setting up new systems without turning OFF the power.

While online, a Unit can be added easily to an empty slot. (This function is supported in Duplex CPU Single I/O Expansion Systems and Duplex CPU Dual I/O Expansion Systems.)

In addition, an Expansion Backplane as well as its mounted Units can be added easily.

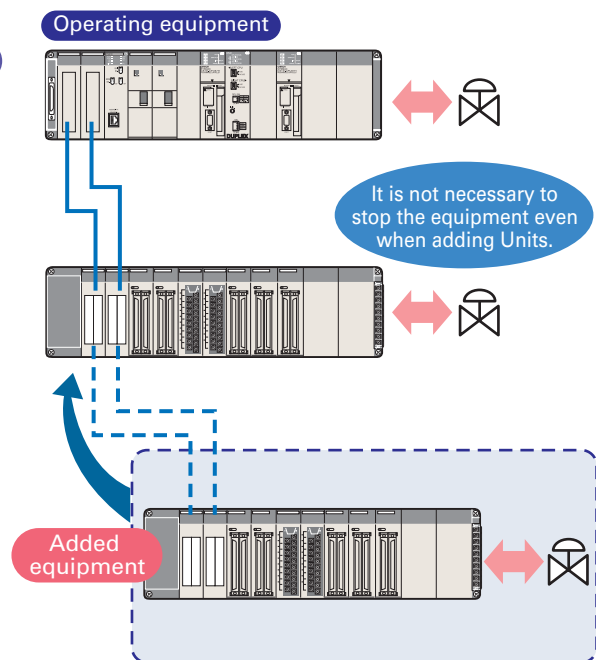
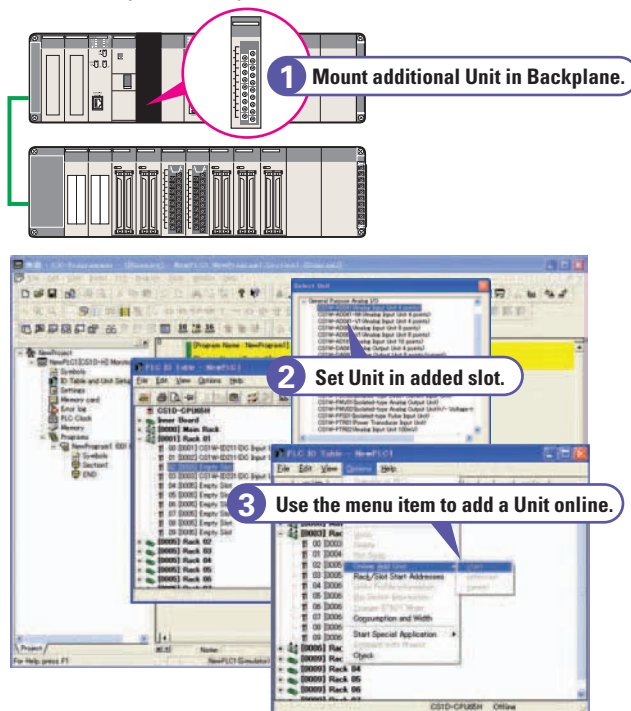

Duplex "Dual I/O Expansion" System

Even Stronger Redundancy!

Expansion Cables can be duplexed and Units can be replaced Online.

By duplexing the Expansion Units and Expansion Cables, the Expansion Cables are duplexed and can be replaced during operation. In addition, cable disconnections are monitored so failures can be located easily.

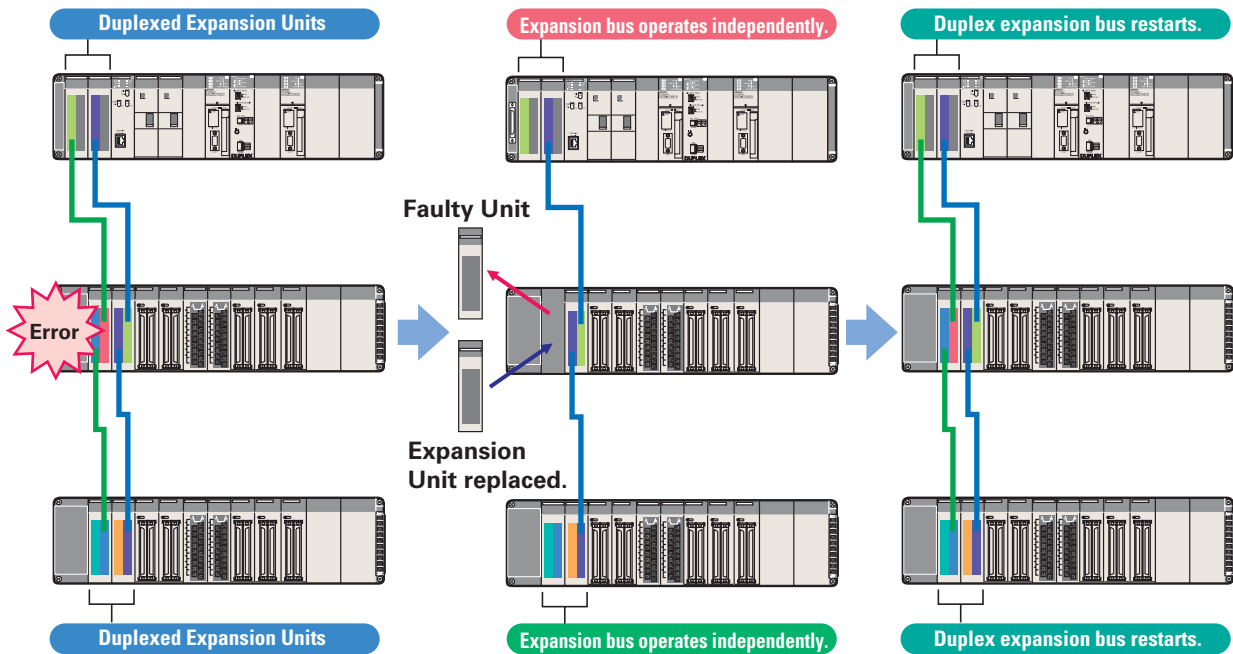

Duplex Units can be replaced online.

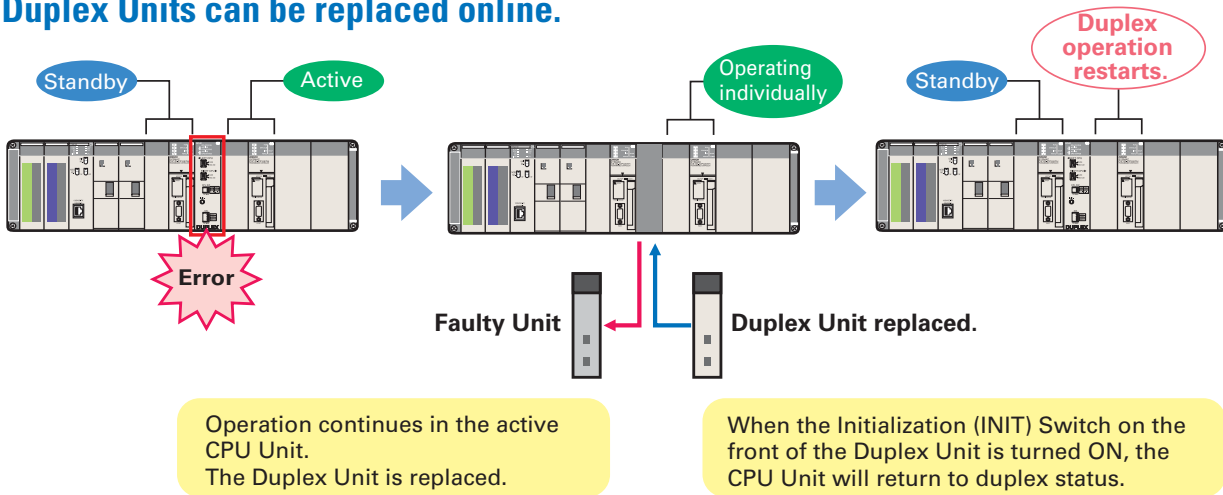

A PLC-based Duplex Process Control System That Achieves High Reliability

A variety of system configurations can be created, such as a Duplex CPU System using a CS1D Process-control CPU Unit with a built-in Loop Control Board (LCB) function or a Single CPU System using a Loop Control Board mounted in the CS1D CPU Unit's Inner Board slot. You can retain the openness and cost performance of a general-purpose PLC base while expanding the possible range of PLC control with process control functions and reliability that are equivalent to some of the functions and performance of DCS.

Loop control engine

Loop Control (LCB)
Section: CX-Process Tool

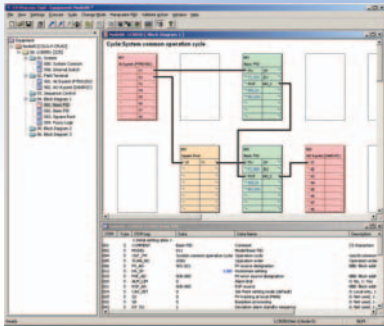

Sequence control engine

CPU Section: CX-Programmer

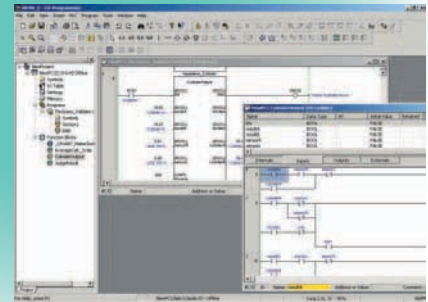

A Process Control System can be built based on PLCs, breaking the image of traditional process controllers. A system configuration can be created to match the applications and customer's system requirements.

Previous System Issues

(Initial costs are high because a large-scale system must be used.)

PLC-based Process Control Solution

(*Down-sizing* Using the PLC base saves cost, space, and time.)

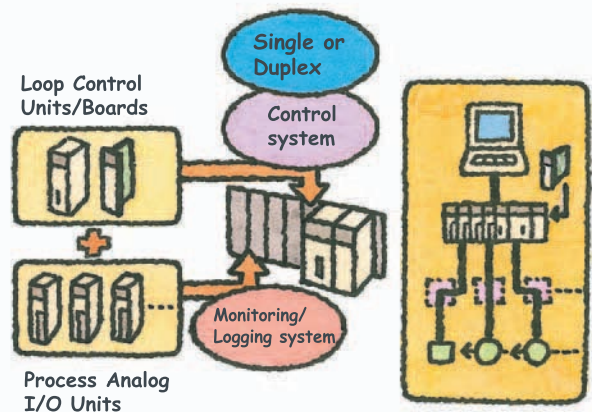
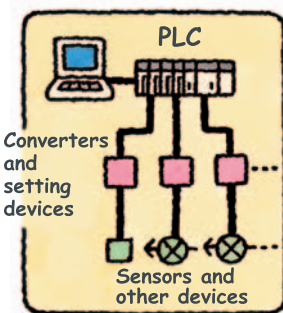

stem for Full-scale Process Control

Reduce the Total Cost of Ownership from Initial Costs to Operating Costs. A PLC-based Process Control System Answers the Customer's Needs.

Engineering: CX-Process Tool

Loop control programs can be created easily with function block programming.

Combine function blocks and use the mouse to connect them.

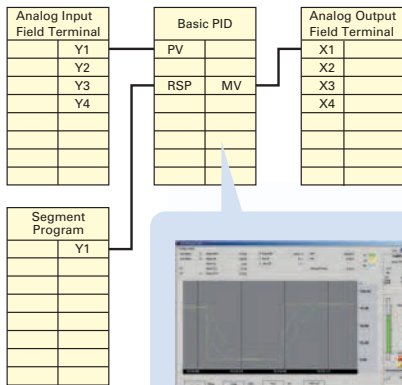

PID parameters can be adjusted on the Tuning Screen.

Input/Output: Process I/O Units

Functions such as isolator, power supply, and signal converter functions are implemented in these Analog I/O Units. Since functions such as process value alarms, rate-of-change calculations, and square-root calculations are built into the Units, significant cost and space savings can be realized compared to the previous system.

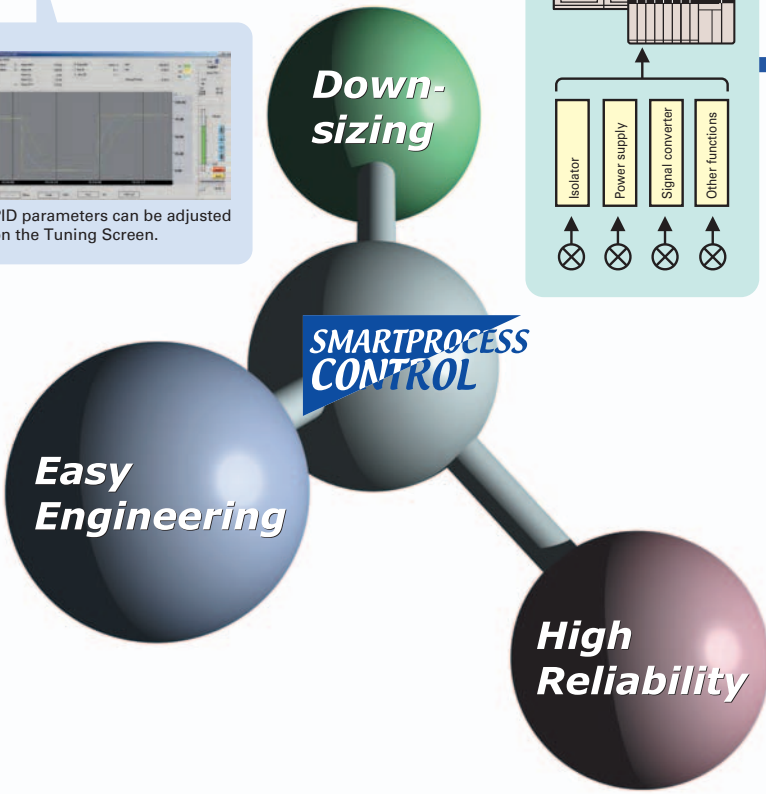
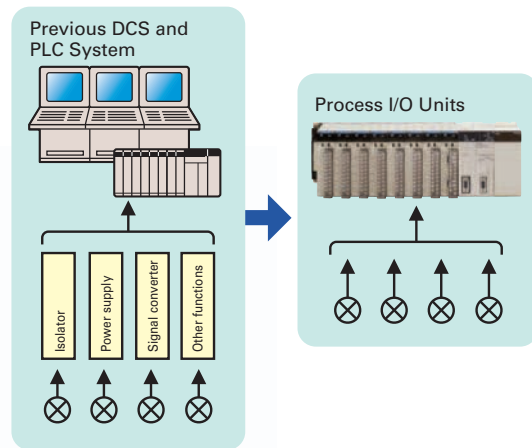

Duplex System: CS1D

Loop control programs can be duplexed, not just sequence control programs. The CS1D Duplex System can provide a solution to risk management in process applications that require high reliability.



MEMO

A large grid of dashed lines for writing a memo. The grid consists of 20 columns and 20 rows of squares, forming a coordinate system for notes.

System Design Guide

System Configuration	16
SYSTEM 1: Duplex CPU, Dual I/O Expansion System	
SYSTEM 2: Duplex CPU, Single I/O Expansion System	
SYSTEM 3: Single CPU System	
Dimensions	31
General Specifications	32
CPU Units	33
Common Specifications	34
Functions Added by Unit Version	36

System Configuration

Basic System

SYSTEM 1 CS1D Duplex CPU, Dual I/O Expansion System

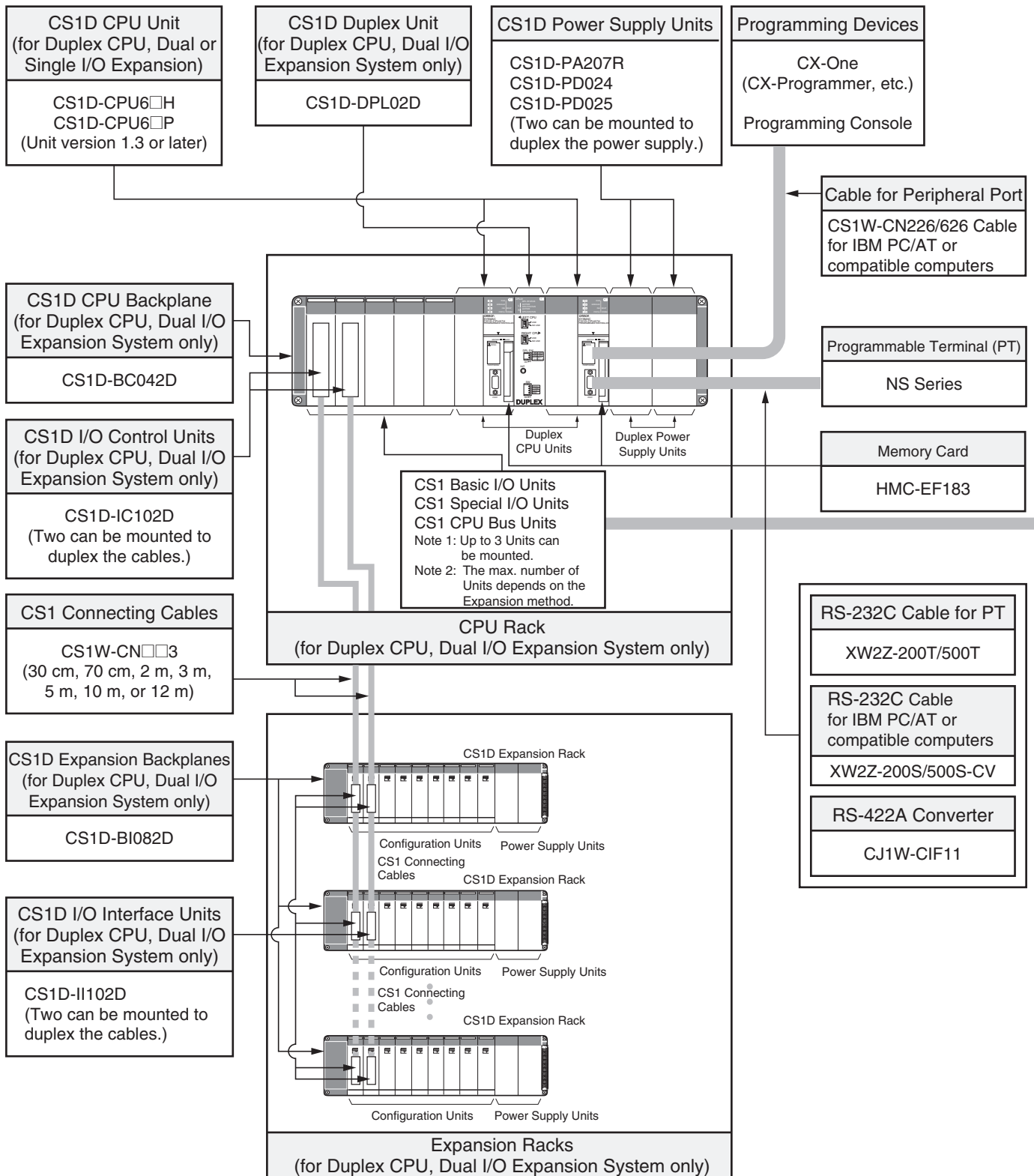

Configuration Units

Basic I/O Units				
8 I/O points	16 I/O points	32 I/O points	64 I/O points	96 I/O points
Input Units				
---	<ul style="list-style-type: none"> DC Input Units CS1W-ID211 AC Input Units CS1W-IA111 CS1W-IA211 	<ul style="list-style-type: none"> DC Input Units CS1W-ID231 	<ul style="list-style-type: none"> DC Input Units CS1W-ID261 	<ul style="list-style-type: none"> DC Input Units CS1W-ID291
Output Units				
<ul style="list-style-type: none"> Triac Output Units CS1W-OA201 Relay Output Units (independent commons) CS1W-OC201 	<ul style="list-style-type: none"> Transistor Output Units CS1W-OD21□ Triac Output Units CS1W-OA211 Relay Output Units CS1W-OC211 	<ul style="list-style-type: none"> Transistor Output Units CS1W-OD23□ 	<ul style="list-style-type: none"> Transistor Output Units CS1W-OD26□ 	<ul style="list-style-type: none"> Transistor Output Units CS1W-OD29□
I/O Units				
---	---	---	<ul style="list-style-type: none"> 32 inputs and 32 outputs DC Input/Transistor Output Units CS1W-MD26□ TTL I/O Units CS1W-MD561 	<ul style="list-style-type: none"> 48 inputs and 48 outputs DC Input/Transistor Output Units CS1W-MD29□
Other Units				
---	<ul style="list-style-type: none"> Interrupt Input Units CS1W-INT01 High-speed Input Units CS1W-IDP01 	<ul style="list-style-type: none"> B7A Interface Units • 32 inputs CS1W-B7A12 • 32 outputs CS1W-B7A02 • 16 inputs and 16 outputs CS1W-B7A21 	<ul style="list-style-type: none"> B7A Interface Units • 32 inputs and 32 outputs CS1W-B7A22 	---

Special I/O Units and CPU Bus Units			
<ul style="list-style-type: none"> Temperature Sensor Input Units (Process Analog I/O Units) CS1W-PTS□□ Analog Input Units Analog Input Units CS1W-AD041-V1 CS1W-AD081-V1 CS1W-AD161 Process Analog Input Units such as Isolated-type DC Input Units CS1W-PDC□□ CS1W-PTW01 CS1W-PTR0□ Analog Output Units Analog Output Units CS1W-DA041 CS1W-DA08V CS1W-DA08C Isolated-type Analog Output Units (Process Analog I/O Units) CS1W-PMV01 CS1W-PMV02 Analog I/O Units CS1W-MAD44 Isolated-type Pulse Input Unit (Process Analog I/O Unit) CS1W-PPS01 	<ul style="list-style-type: none"> High-speed Counter Units CS1W-CT021 CS1W-CT041 Customizable Counter Units CS1W-HCP22-V1 CS1W-HCA□2-V1 CS1W-HIO01-V1 Position Control Units CS1W-NC1□3 CS1W-NC2□3 CS1W-NC4□3 MECHATROLINK-II-compatible Position Control Units CS1W-NC271 CS1W-NC471 CS1W-NCF71 Motion Control Units CS1W-MC221-V1 CS1W-MC421-V1 MECHATROLINK-II-compatible Motion Control Units CS1W-MCH71 	<ul style="list-style-type: none"> Serial Communications Units CS1W-SCU21-V1 CS1W-SCU31-V1 EtherNet/IP Units CS1W-EIP21 Ethernet Units CS1W-ETN21 CS1D-ETN21D Controller Link Units CS1W-CLK23 CS1W-CLK13 CS1W-CLK53 SYSMAC LINK Units CS1W-SLK11 CS1W-SLK21 FL-Net Units CS1W-FLN22 DeviceNet Units CS1W-DRM21-V1 CompoNet Master Units CS1W-CRM21 	<ul style="list-style-type: none"> ID Sensor U Units CS1W-V680C11 CS1W-V680C12 CS1W-V600C11 CS1W-V600C12 • GPIB Interface Units CS1W-GPI01 • High-speed Data Storage Units CS1W-SPU01-V2 CS1W-SPU02-V2

Note: 1. Windows is a registered trademark of Microsoft Corporation in the USA. MECHATROLINK II is a registered trademark of the MECHATROLINK Members Association.
 Other company names and product names etc. are the trademarks or registered trademarks of their respective companies.
 2. Including models whose production are discontinued.

Basic System

SYSTEM 1 CS1D Duplex CPU, Dual I/O Expansion System

The entire system, including the expansion cables, can be duplexed for the most advanced redundancy and maintenance functions.
The CPU Unit's version must be unit version 1.3 or later.

■ CPU Rack

System Configuration

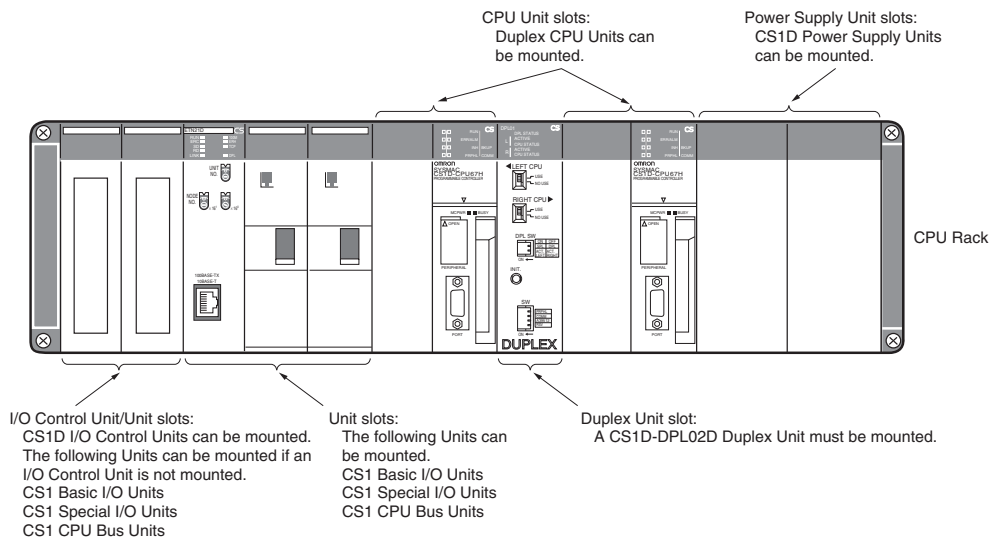

List of Required Devices

Rack	Unit name	Number required	
CPU Rack	CS1D-BC042D CPU Backplane (for Duplex CPU Dual I/O Expansion Systems)	1 Backplane	
	CS1D-PA207R/CS1D-PD02□ Power Supply Unit	2 Units (Just 1 Unit can also be used.)	
	CS1D-CPU6□H/CS1D-CPU6□P CPU Unit	2 Units	
	CS1D-DPL02D Duplex Unit (for Duplex CPU Dual I/O Expansion Systems)	1 Unit	
	CS1D-IC102D I/O Control Unit (for Duplex CPU Dual I/O Expansion Systems)	Required only when there is an I/O Expansion System. Two Units are required for a Dual I/O Expansion System, and just one Unit is required for a Single I/O Expansion System.	
	Maximum number of I/O Units	Dual I/O Expansion System	3 Units
		Single I/O Expansion System	4 Units
No I/O Expansion		5 Units	

Limitations on the System Configuration

- Note:**
1. C200H-series Units cannot be used in either the CPU Rack or Expansion Racks.
 2. The CPU Units do not support FB or ST programming.
 3. CPU Units with unit version 1.3 or later can be used.

Dual I/O Expansion Racks

The Dual I/O Expansion System has a duplexed expansion bus and supports online replacement of a Duplex Unit, online replacement of Units without a Programming Device, and online addition of I/O Units and Expansion Backplanes. (These functions are supported by the Duplex CPU Dual I/O Expansion System only.) Special I/O Control Units and I/O Interface Units are used in the Dual I/O Expansion System. The expansion bus can be set to either single or dual operation.

System Configuration Diagram

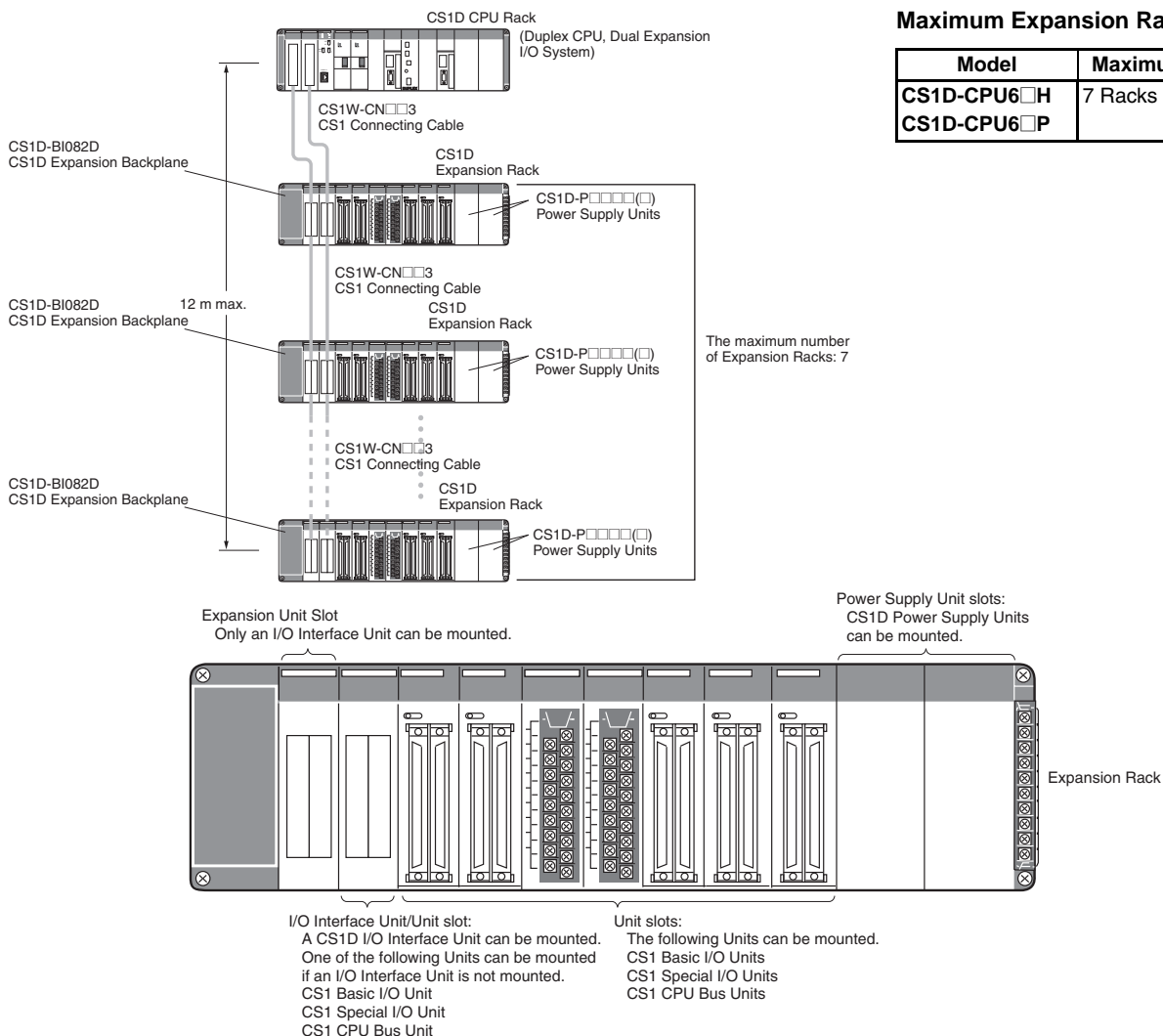

List of Required Devices

Rack	Unit name	Number required	
CPU Rack	CS1D-IC102D I/O Control Unit (for Duplex CPU Dual I/O Expansion Systems)	Two Units are required for a Dual I/O Expansion System, and just one Unit is required for a Single I/O Expansion System.	
	Maximum number of I/O Units	Dual I/O Expansion System	3 Units
		Single I/O Expansion System	4 Units

Rack	Unit name	Number required
Expansion Rack	CS1D-BI082D Expansion Backplane (for Duplex CPU Dual I/O Expansion Systems)	1 Backplane
	CS1D-PA207R/CS1D-PD02□ Power Supply Unit	2 Units (Just 1 Unit can also be used.)
	CS1D-II102D I/O Interface Unit (for Duplex CPU Dual I/O Expansion Systems)	Two Units are required for a Dual I/O Expansion System, and just one Unit is required for a Single I/O Expansion System.
	Maximum number of I/O Units	Dual I/O Expansion System
Single I/O Expansion System		8 Units

Limitations on the System Configuration

- Note:**
- Dual I/O Expansion cannot be used in a Duplex CPU Single I/O Expansion System or Single CPU System.
 - The number of I/O Units that can be mounted in the Backplanes depends on the expansion method being used.

Basic System

SYSTEM 2 CS1D Duplex CPU, Single I/O Expansion System

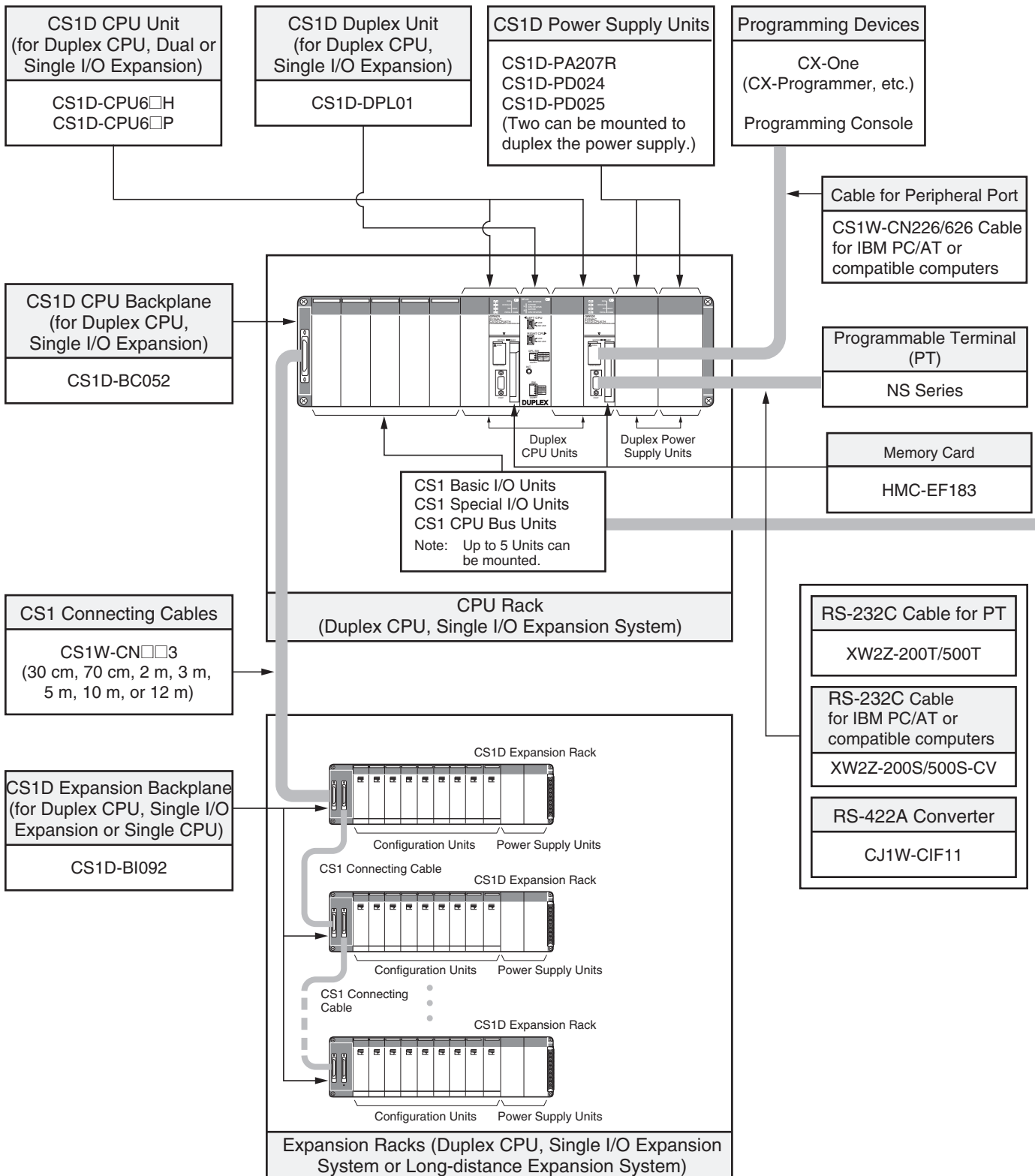

Configuration Units

Basic I/O Units				
8 I/O points	16 I/O points	32 I/O points	64 I/O points	96 I/O points
Input Units				
---	<ul style="list-style-type: none"> • DC Input Units CS1W-ID211 • AC Input Units CS1W-IA111 CS1W-IA211 	<ul style="list-style-type: none"> • DC Input Units CS1W-ID231 	<ul style="list-style-type: none"> • DC Input Units CS1W-ID261 	<ul style="list-style-type: none"> • DC Input Units CS1W-ID291
Output Units				
<ul style="list-style-type: none"> • Triac Output Units CS1W-OA201 • Relay Output Units (independent commons) CS1W-OC201 	<ul style="list-style-type: none"> • Transistor Output Units CS1W-OD21□ • Triac Output Units CS1W-OA211 • Relay Output Units CS1W-OC211 	<ul style="list-style-type: none"> • Transistor Output Units CS1W-OD23□ 	<ul style="list-style-type: none"> • Transistor Output Units CS1W-OD26□ 	<ul style="list-style-type: none"> • Transistor Output Units CS1W-OD29□
I/O Units				
---	---	---	32 inputs and 32 outputs <ul style="list-style-type: none"> • DC Input/Transistor Output Units CS1W-MD26□ • TTL I/O Units CS1W-MD561 	48 inputs and 48 outputs <ul style="list-style-type: none"> • DC Input/Transistor Output Units CS1W-MD29□
Other Units				
---	<ul style="list-style-type: none"> • Interrupt Input Units CS1W-INT01 • High-speed Input Units CS1W-IDP01 	B7A Interface Units <ul style="list-style-type: none"> • 32 inputs CS1W-B7A12 • 32 outputs CS1W-B7A02 • 16 inputs and 16 outputs CS1W-B7A21 	B7A Interface Units <ul style="list-style-type: none"> • 32 inputs and 32 outputs CS1W-B7A22 	---

Special I/O Units and CPU Bus Units			
Temperature Sensor Input Units (Process Analog I/O Units) <ul style="list-style-type: none"> • CS1W-PTS□□ Analog Input Units <ul style="list-style-type: none"> • Analog Input Units CS1W-AD041-V1 CS1W-AD081-V1 CS1W-AD161 • Process Analog Input Units such as Isolated-type DC Input Units CS1W-PDC□□ CS1W-PTW01 CS1W-PTR0□ Analog Output Units <ul style="list-style-type: none"> • Analog Output Units CS1W-DA041 CS1W-DA08V CS1W-DA08C • Isolated-type Analog Output Units (Process Analog I/O Units) CS1W-PMV01 CS1W-PMV02 Analog I/O Units <ul style="list-style-type: none"> • CS1W-MAD44 Isolated-type Pulse Input Unit (Process Analog I/O Unit) <ul style="list-style-type: none"> • CS1W-PPS01 	<ul style="list-style-type: none"> • High-speed Counter Units CS1W-CT021 CS1W-CT041 • Customizable Counter Units CS1W-HCP22-V1 CS1W-HCA□2-V1 CS1W-HIO01-V1 • Position Control Units CS1W-NC1□3 CS1W-NC2□3 CS1W-NC4□3 • MECHATROLINK-II-compatible Position Control Units CS1W-NC271 CS1W-NC471 CS1W-NCF71 • Motion Control Units CS1W-MC221-V1 CS1W-MC421-V1 • MECHATROLINK-II-compatible Motion Control Units CS1W-MCH71 	<ul style="list-style-type: none"> • Serial Communications Units CS1W-SCU21-V1 CS1W-SCU31-V1 • EtherNet/IP Units CS1W-EIP21 • Ethernet Units CS1W-ETN21 CS1D-ETN21D • Controller Link Units CS1W-CLK23 CS1W-CLK13 CS1W-CLK53 • SYSMAC LINK Units CS1W-SLK11 CS1W-SLK21 • FL-Net Units CS1W-FLN22 • DeviceNet Units CS1W-DRM21-V1 • CompoNet Master Units CS1W-CRM21 	<ul style="list-style-type: none"> • ID Sensor U Units CS1W-V680C11 CS1W-V680C12 CS1W-V600C11 CS1W-V600C12 • GPIB Interface Units CS1W-GPI01 • High-speed Data Storage Units CS1W-SPU01-V2 CS1W-SPU02-V2

Note: 1. Windows is a registered trademark of Microsoft Corporation in the USA. MECHATROLINK II is a registered trademark of the MECHATROLINK Members Association. Other company names and product names etc. are the trademarks or registered trademarks of their respective companies.
 2. Including models whose production are discontinued.

Basic System

SYSTEM 2 CS1D Duplex CPU, Single I/O Expansion System

The main system components can be duplexed, such as the CPU Unit, Power Supply Unit, and Communications Unit. Units can be replaced online using a Programming Device. This system is equivalent to the previous CS1D Duplex CPU System.

■ CPU Rack

System Configuration

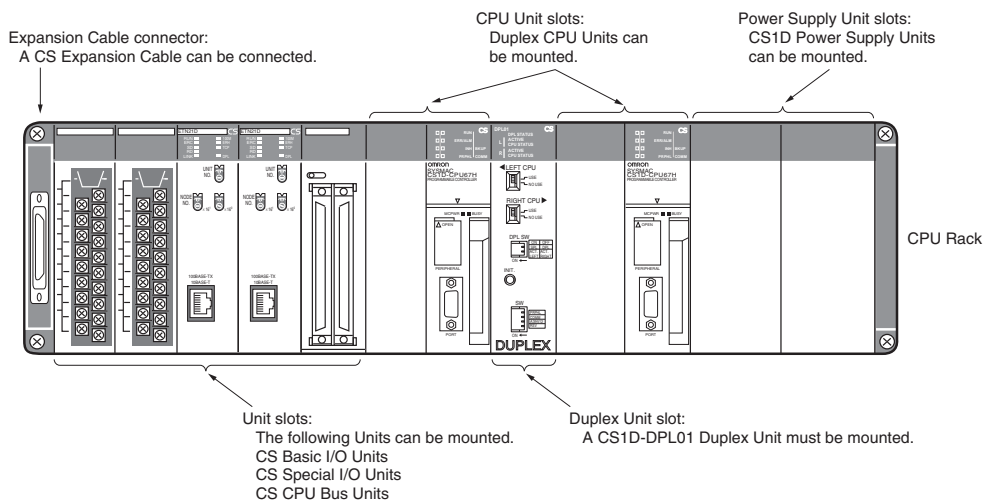

List of Required Devices

Rack	Unit name	Number required
CPU Rack	CS1D-BC052 CPU Backplane (for Duplex CPU Single I/O Expansion Systems)	1 Backplane
	CS1D-PA207R/CS1D-PD02□ Power Supply Unit	2 Units (Just 1 Unit can also be used.)
	CS1D-CPU6□H/CS1D-CPU6□P CPU Unit	2 Units
	CS1D-DPL01 Duplex Unit (for Duplex CPU Single I/O Expansion Systems)	1 Unit
	Maximum number of Configuration Units	5 Units

Limitations on the System Configuration

- Note:**
1. C200H-series Units cannot be used in either the CPU Rack or Expansion Racks.
 2. The CPU Units do not support FB or ST programming.

Single I/O Expansion Racks

Like the CS1-series PLCs, it is possible to connect Expansion Racks and expand the PLC system just by connecting Expansion Cables. The Duplex CPU Single I/O Expansion System supports the same functions as Single CPU System. Special I/O Control Units and I/O Interface Units are not required.

System Configuration Diagram

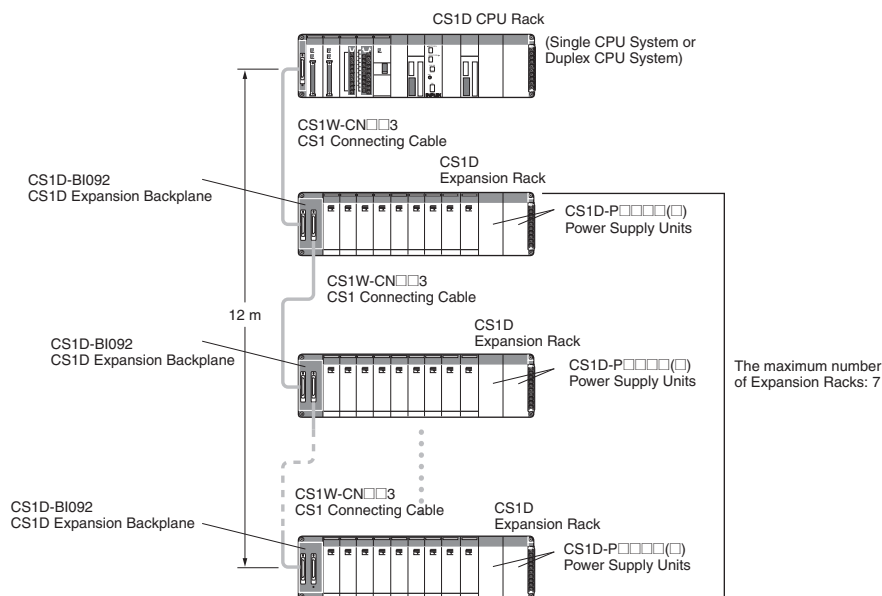

Maximum Expansion Racks

Model	Maximum No. of Racks
CS1D-CPU6□H	7 Racks
CS1D-CPU6□P	

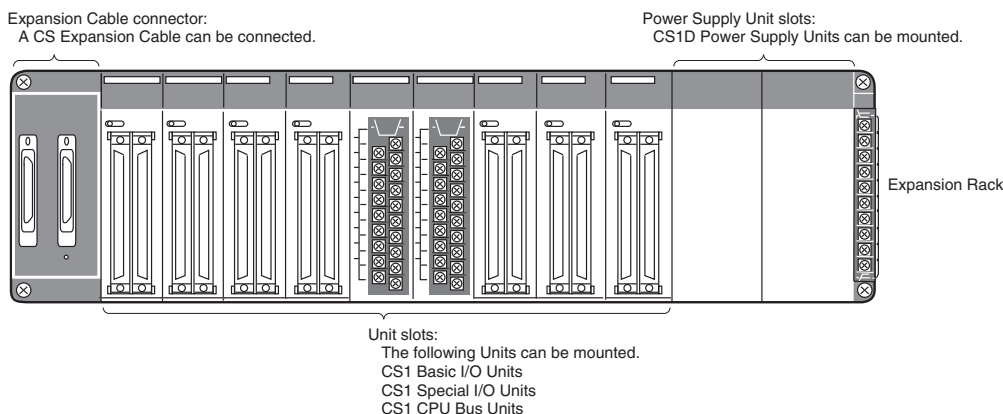

List of Required Devices

Rack	Unit name		Number required
CPU Rack	Maximum number of Configuration Units	Duplex CPU, Single I/O Expansion System	5 Units
		Single CPU System	8 Units

Rack	Unit name		Number required
Expansion Rack	CS1D-BI092 Expansion Backplane (for Duplex CPU Single I/O Expansion Systems or Single CPU Systems)		1 Backplane
	CS1D-PA207R/CS1D-PD02□ Power Supply Unit		2 Units (Just 1 Unit can also be used.)
	Maximum number of I/O Units (Duplex CPU Single I/O Expansion System or Single CPU System)		9 Units

Limitations on the System Configuration

- Note:**
- These Racks cannot be used in a Duplex CPU Dual I/O Expansion System.
 - The following functions cannot be used: Duplex Expansion Cables, Online replacement of a Duplex Unit, Online replacement of Units without a Programming Device, and Online addition of I/O Units and Expansion Backplanes. If any of these functions are required, a Duplex CPU, Dual I/O Expansion System must be used.

■ CS1D Long-distance Expansion Racks

A Long-distance Expansion System can connect a Rack at a distance of up to 50 m. The Long-distance Expansion System functions can be used in the Duplex CPU Single I/O Expansion System and Single CPU System. Special I/O Control Units and I/O Interface Units are used.

System Configuration Diagram

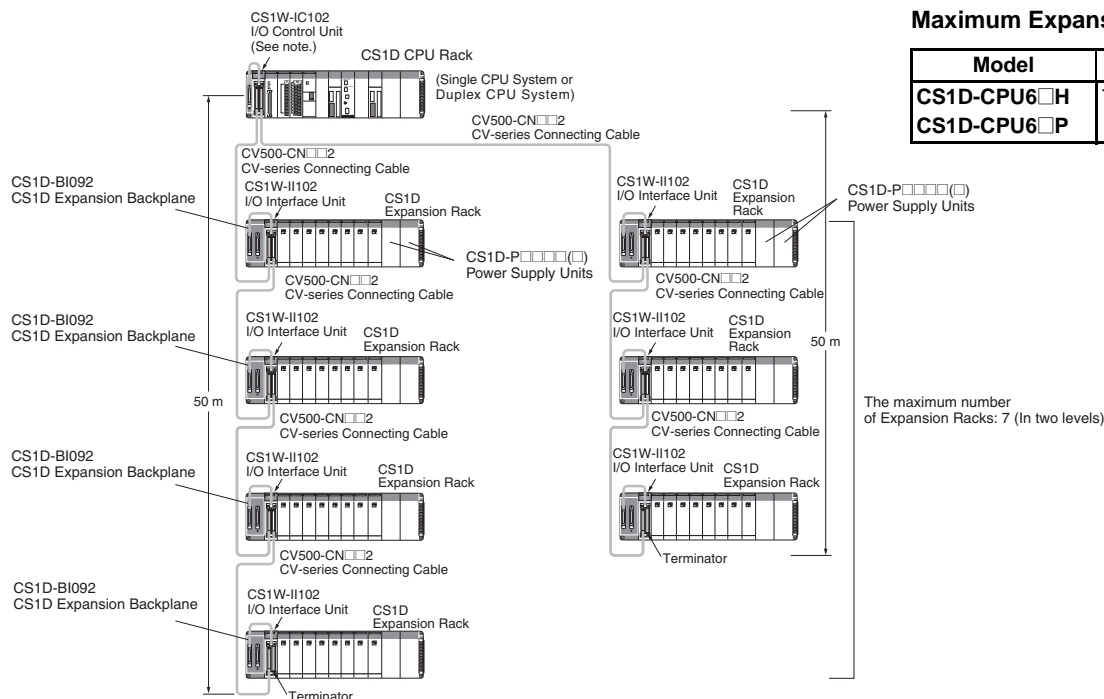

Note: If even one CV500-CN□□2 Cable for Long-distance Expansion is used in the PLC system, an I/O Control Unit is required in the source CS1 Rack.

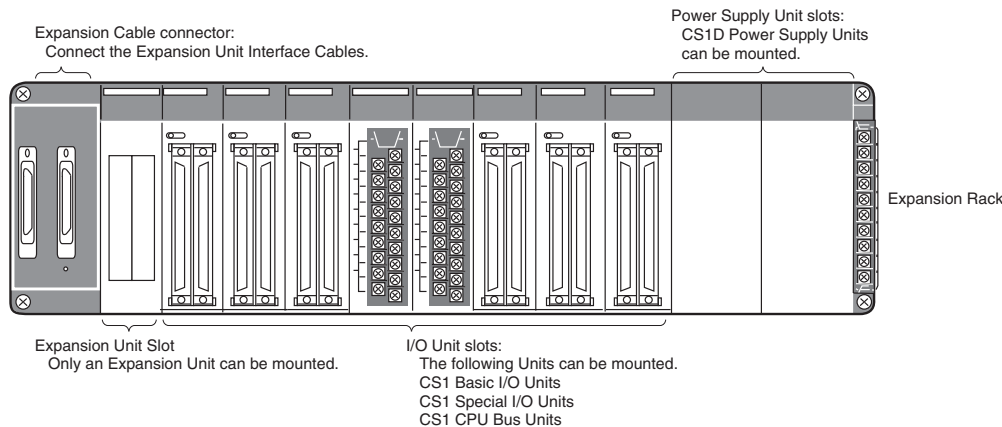

List of Required Devices

Rack	Unit name	Number required	
CPU Rack	CS1D-IC102 I/O Control Unit (for Duplex CPU Single I/O Expansion Systems and Single CPU Systems)	1 Unit	
	Maximum number of Configuration Units	Duplex CPU Single I/O Expansion System	4 Units
		Single CPU System	7 Units

Rack	Unit name	Number required
Expansion Rack	CS1D-BI092 Expansion Backplane (for Duplex CPU Single I/O Expansion Systems or Single CPU Systems)	1 Backplane
	CS1D-PA207R/CS1D-PD02□ Power Supply Unit	2 Units (Just 1 Unit can also be used.)
	CS1W-II102 I/O Interface Unit (for Duplex CPU Single I/O Expansion Systems or Single CPU Systems)	1 Unit
	Maximum number of Configuration Units	8 Units

Limitations on the System Configuration

- Note:**
- These Racks cannot be used in a Duplex CPU Dual I/O Expansion System.
 - The following functions cannot be used: Duplex Expansion Cables, Online replacement of a Duplex Unit, Online replacement of Units without a Programming Device, and Online addition of I/O Units and Expansion Backplanes. If any of these functions are required, a Duplex CPU, Dual I/O Expansion System must be used.

Basic System

SYSTEM 3 CS1D Single CPU System

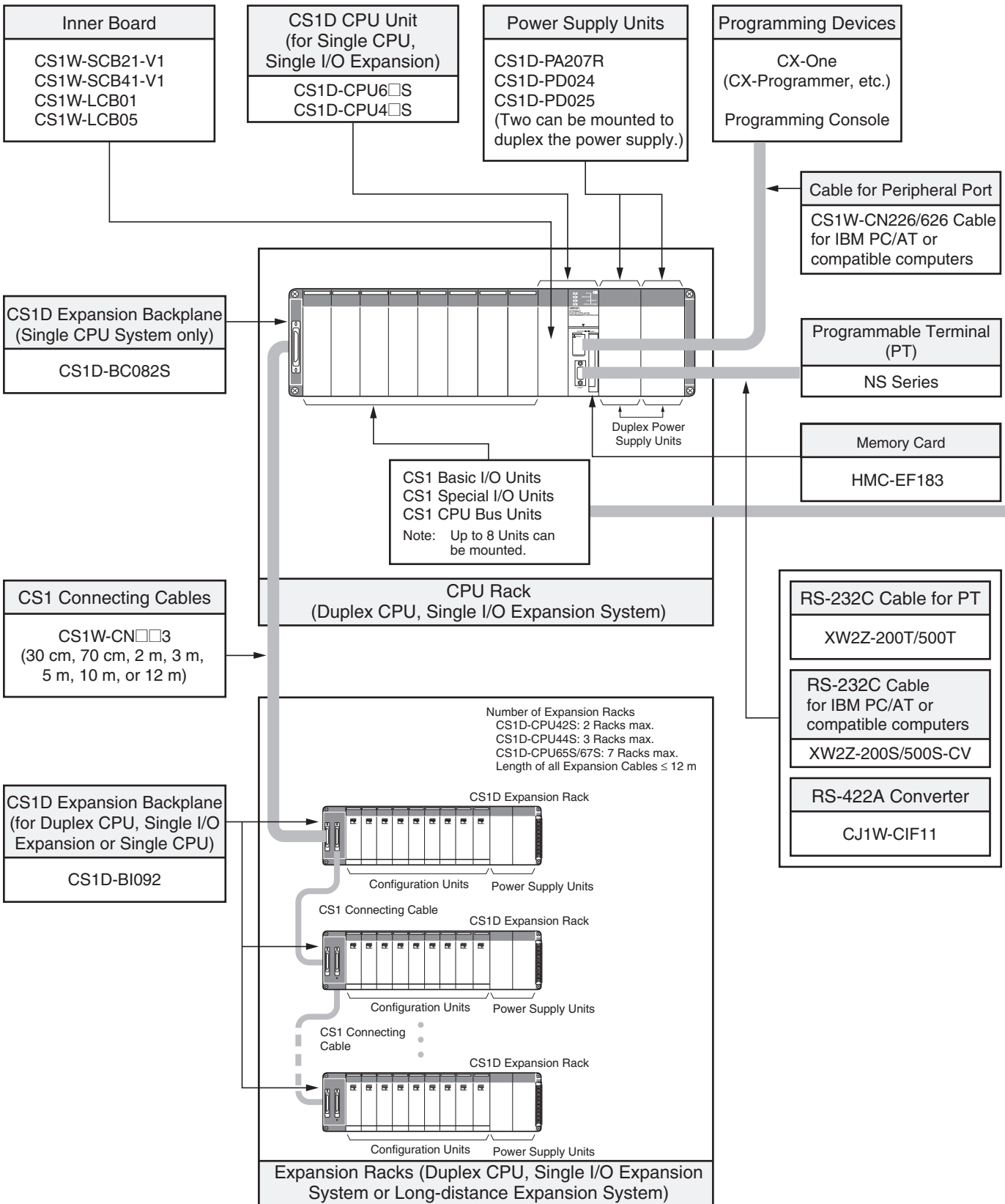

Configuration Units

Basic I/O Units				
8 I/O points	16 I/O points	32 I/O points	64 I/O points	96 I/O points
Input Units				
---	<ul style="list-style-type: none"> DC Input Units CS1W-ID211 AC Input Units CS1W-IA111 CS1W-IA211 	<ul style="list-style-type: none"> DC Input Units CS1W-ID231 	<ul style="list-style-type: none"> DC Input Units CS1W-ID261 	<ul style="list-style-type: none"> DC Input Units CS1W-ID291
Output Units				
<ul style="list-style-type: none"> Triac Output Units CS1W-OA201 Relay Output Units (independent commons) CS1W-OC201 	<ul style="list-style-type: none"> Transistor Output Units CS1W-OD21□ Triac Output Units CS1W-OA211 Relay Output Units CS1W-OC211 	<ul style="list-style-type: none"> Transistor Output Units CS1W-OD23□ 	<ul style="list-style-type: none"> Transistor Output Units CS1W-OD26□ 	<ul style="list-style-type: none"> Transistor Output Units CS1W-OD29□
I/O Units				
---	---	---	<ul style="list-style-type: none"> 32 inputs and 32 outputs DC Input/Transistor Output Units CS1W-MD26□ TTL I/O Units CS1W-MD561 	<ul style="list-style-type: none"> 48 inputs and 48 outputs DC Input/Transistor Output Units CS1W-MD29□
Other Units				
---	<ul style="list-style-type: none"> Interrupt Input Units CS1W-INT01 	<ul style="list-style-type: none"> B7A Interface Units • 32 inputs CS1W-B7A12 • 32 outputs CS1W-B7A02 • 16 inputs and 16 outputs CS1W-B7A21 	<ul style="list-style-type: none"> B7A Interface Units • 32 inputs and 32 outputs CS1W-B7A22 	---

Special I/O Units, CPU Bus Units, and Inner Boards			
<ul style="list-style-type: none"> Temperature Sensor Input Units (Process Analog I/O Units) • CS1W-PTS□□ Analog Input Units • Analog Input Units CS1W-AD041-V1 CS1W-AD081-V1 CS1W-AD161 • Process Analog Input Units such as Isolated-type DC Input Units CS1W-PDC□□ CS1W-PTW01 CS1W-PTRO□ Analog Output Units • Analog Output Units CS1W-DA041 CS1W-DA08V CS1W-DA08C • Isolated-type Analog Output Units (Process Analog I/O Units) CS1W-PMV01 CS1W-PMV02 Analog I/O Units • CS1W-MAD44 Isolated-type Pulse Input Unit (Process Analog I/O Unit) • CS1W-PPS01 Loop Control Boards • CS1W-LCB01 • CS1W-LCB05 	<ul style="list-style-type: none"> High-speed Counter Units CS1W-CT021 CS1W-CT041 Customizable Counter Units CS1W-HCP22-V1 CS1W-HCA□2-V1 CS1W-HIO01-V1 Position Control Units CS1W-NC1□3 CS1W-NC2□3 CS1W-NC4□3 MECHATROLINK-II-compatible Position Control Units CS1W-NC271 CS1W-NC471 CS1W-NCF71 Motion Control Units CS1W-MC221-V1 CS1W-MC421-V1 MECHATROLINK-II-compatible Motion Control Units CS1W-MCH71 	<ul style="list-style-type: none"> Serial Communications Boards CS1W-SCB21-V1 CS1W-SCB41-V1 Serial Communications Units CS1W-SCU21-V1 CS1W-SCU31-V1 EtherNet/IP Units CS1W-EIP21 Ethernet Units CS1W-ETN21 CS1D-ETN21D Controller Link Units CS1W-CLK23 CS1W-CLK13 CS1W-CLK53 SYSMAC LINK Units CS1W-SLK11 CS1W-SLK21 FL-Net Units CS1W-FLN22 DeviceNet Units CS1W-DRM21-V1 CompoNet Master Units CS1W-CRM21 	<ul style="list-style-type: none"> ID Sensor U Units CS1W-V680C11 CS1W-V680C12 CS1W-V600C11 CS1W-V600C12 • GPIB Interface Units CS1W-GPI01 • High-speed Data Storage Units CS1W-SPU01-V2 CS1W-SPU02-V2

Note: 1. Windows is a registered trademark of Microsoft Corporation in the USA. MECHATROLINK II is a registered trademark of the MECHATROLINK Members Association. Other company names and product names etc. are the trademarks or registered trademarks of their respective companies.
 2. Including models whose production are discontinued.

Basic System

SYSTEM 3 CS1D Single CPU System

This system configuration is ideal when you want to replace a Power Supply Unit or other Units online or improve redundancy in the Communications section. There are no changes in particular from the earlier Single CPU System.

■ CPU Rack

System Configuration Diagram

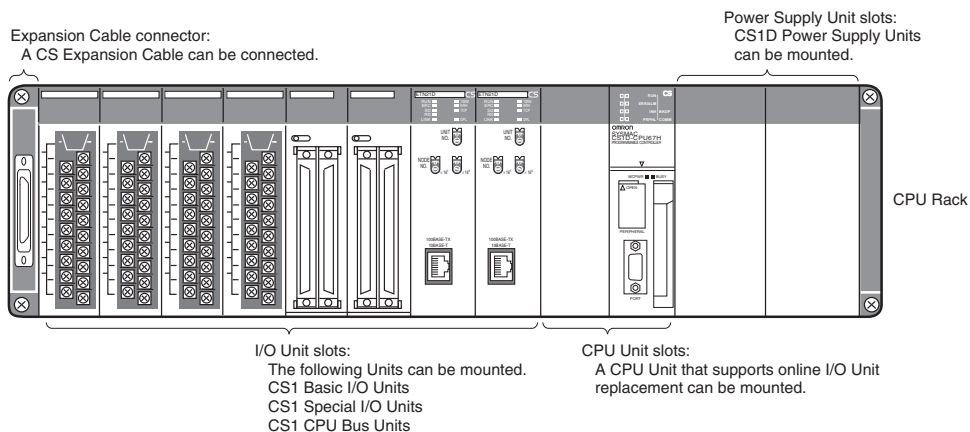

List of Required Devices

Rack	Unit name	Number required
CPU Rack	CS1D-BC082S CPU Backplane (for Single CPU Systems)	1 Backplane
	CS1D-PA207R/CS1D-PD02□ Power Supply Unit	2 Units (Just 1 Unit can also be used.)
	CS1D-CPU6□S/CS1D-CPU4□S CPU Unit	1 Unit
	Maximum number of Configuration Units	8 Units

Limitations on the System Configuration

- Note:**
1. C200H-series Units cannot be used in either the CPU Rack or Expansion Racks.
 2. The CPU Units do not support FB or ST programming.

Single I/O Expansion Racks

Like the CS1-series PLCs, it is possible to connect Expansion Racks and expand the PLC system just by connecting Expansion Cables. The Single CPU System supports the same functions as Duplex CPU Single I/O Expansion System. Special I/O Control Units and I/O Interface Units are not required.

System Configuration Diagram

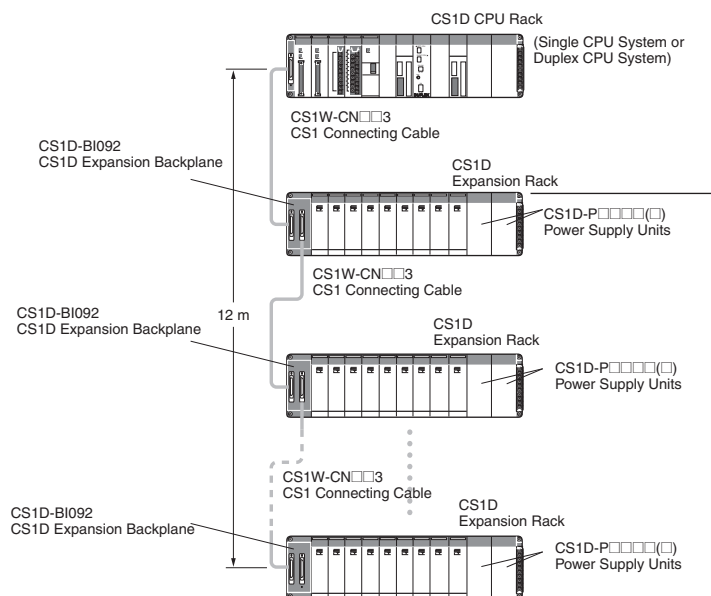

Maximum Expansion Racks

Model	Maximum No. of Racks
CS1D-CPU6□S	7 Racks
CS1D-CPU44S	3 Racks
CS1D-CPU42S	2 Racks

The maximum number of Expansion Racks: 7

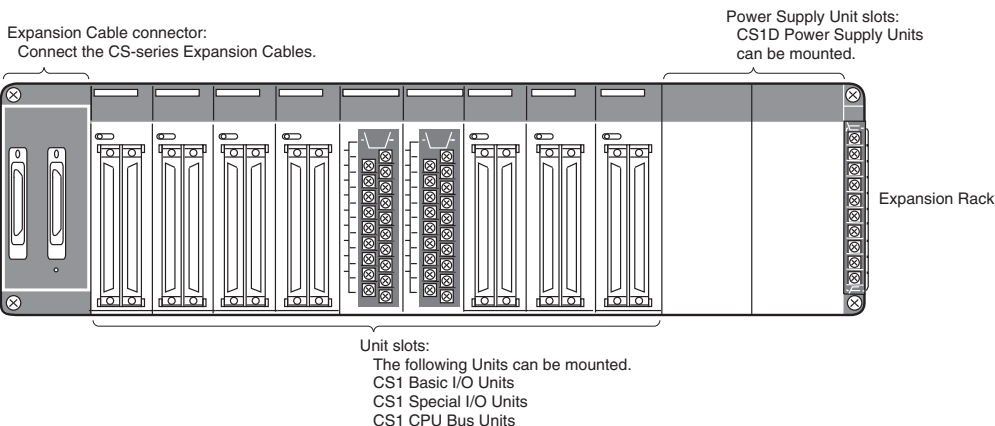

List of Required Devices

Rack	Unit name	Number required
CPU Rack	Maximum number of Configuration Units	Duplex CPU, Single I/O Expansion System
		Single CPU System

Rack	Unit name	Number required
Expansion Rack	CS1D-BI092 Expansion Backplane (for Duplex CPU Single I/O Expansion Systems or Single CPU Systems)	1 Backplane
	CS1D-PA207R/CS1D-PD02□ Power Supply Unit	2 Units (Just 1 Unit can also be used.)
	Maximum number of I/O Units (Duplex CPU Single I/O Expansion System or Single CPU System)	9 Units

Limitations on the System Configuration

- Note:**
1. These Racks cannot be used in a Duplex CPU Dual I/O Expansion System.
 2. The following functions cannot be used: Duplex Expansion Cables, Online replacement of a Duplex Unit, Online replacement of Units without a Programming Device, and Online addition of I/O Units and Expansion Backplanes. If any of these functions are required, a Duplex CPU, Dual I/O Expansion System must be used.

■ CS1D Long-distance Expansion Racks

A Long-distance Expansion System can connect a Rack at a distance of up to 50 m. The Long-distance Expansion System functions can be used in the Duplex CPU Single I/O Expansion System and Single CPU System. Special I/O Control Units and I/O Interface Units are used.

System Configuration Diagram

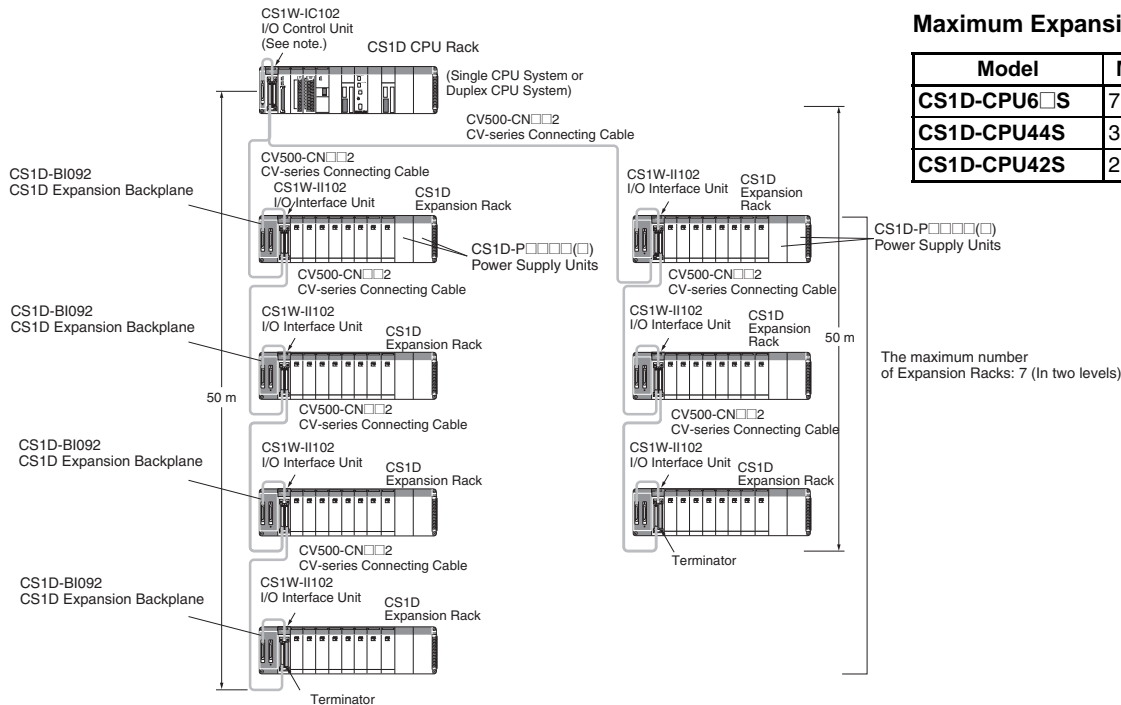

Maximum Expansion Racks

Model	Maximum No. of Racks
CS1D-CPU6□S	7 Racks
CS1D-CPU44S	3 Racks
CS1D-CPU42S	2 Racks

Note: If even one CV500-CN□□2 Cable for Long-distance Expansion is used in the PLC system, an I/O Control Unit is required in the source CS1 Rack.

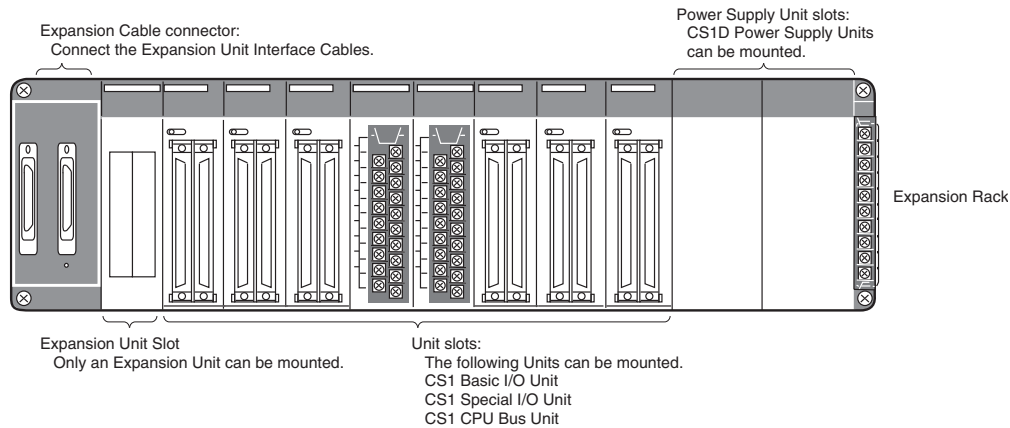

List of Required Devices

Rack	Unit name	Number required	
CPU Rack	CS1W-IC102 I/O Control Unit (for Duplex CPU Single I/O Expansion Systems and Single CPU Systems)	1 Unit	
	Maximum number of Configuration Units	Duplex CPU Single I/O Expansion System	4 Units
		Single CPU System	7 Units
Expansion Rack	CS1D-BI092 Expansion Backplane (for Duplex CPU Single I/O Expansion Systems or Single CPU Systems)	1 Backplane	
	CS1D-PA207R/CS1D-PD02□ Power Supply Unit	2 Units (Just 1 Unit can also be used.)	
	CS1W-II102 I/O Interface Unit (for Duplex CPU Single I/O Expansion Systems or Single CPU Systems)	1 Unit	
	Maximum number of Configuration Units	8 Units	

Limitations on the System Configuration

- Note:**
- These Racks cannot be used in a Duplex CPU Dual I/O Expansion System.
 - The following functions cannot be used: Duplex Expansion Cables, Online replacement of a Duplex Unit, Online replacement of Units without a Programming Device, and Online addition of I/O Units and Expansion Backplanes. If any of these functions are required, a Duplex CPU, Dual I/O Expansion System must be used.

Dimensions

(Unit: mm)

External Dimensions

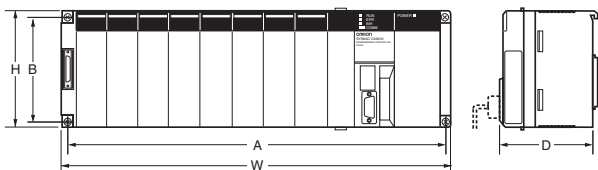

Name	Model	A	B	W	H	D
CS1D CPU Backplane	CS1D-BC042D	491	118	505	132	123
	CS1D-BC052					
	CS1D-BC082S					
CS1D Expansion Backplane	CS1D-BI82D	491	118	505	132	123
	CS1D-BI092					

Backplane Mounting Dimensions

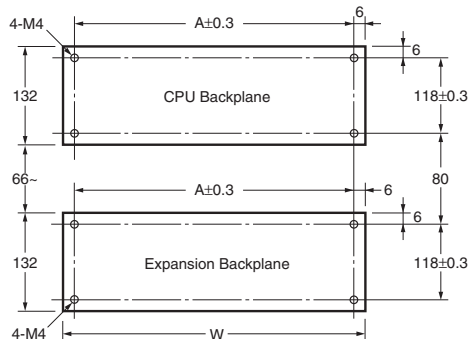

Name	Model	A	W
CS1D CPU Backplane	CS1D-BC042D	491	505
	CS1D-BC052		
	CS1D-BC082S		
CS1D Expansion Backplane	CS1D-BI082D		
	CS1D-BI092		

Mounting Height

The mounting height of CPU Racks and Expansion Racks is 118 to 123 mm, depending on I/O Units mounted. If Programming Devices or connecting cables are attached, the additional dimensions must be taken into account. Allow sufficient clearance in the control panel in which the PLC is mounted.

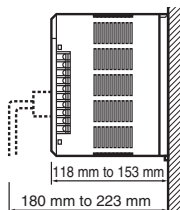

Note: When using Expansion Racks, the total length of the I/O Connecting Cables must be less than 12 m. When bending an I/O Connecting Cables, provide at least the minimum bending radius shown in the following diagrams.

CS1 Connecting Cable

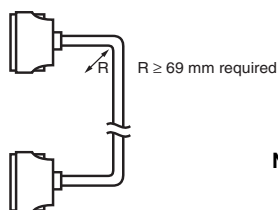

Note: Cable thickness: 8.6 mm dia.

Long-distance Expansion Rack I/O Connecting Cable

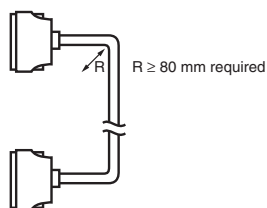

Note: Cable thickness: 10 mm dia.

General Specifications

Item	Power Supply Unit	Specifications		
		CS1D-PA207R	CS1D-PD024	CS1D-PD025
Power supply voltage		100 to 120 V AC/200 to 240 V, 50/60 Hz	24 V DC	
Operating voltage range		85 to 132 V AC/170 to 264 V	19.2 to 28.8 V DC	
Power consumption		150 VA max.	40 W max.	60 W max.
Inrush current		100 to 120 V AC: 30 A max. 200 to 240 VAC: 40 A max.	30 A max.	
Power supply output capacity		5 V DC, 7 A (including the CPU Unit power supply) 26 V DC, 1.3 A Total: 35 W	5 V DC, 4.3 A (including the CPU Unit power supply) 26 V DC, 0.56 A Total: 28 W	5 V DC, 5.3 A (including the CPU Unit power supply) 26 V DC, 1.3 A Total: 40 W
Power supply output terminal		Not provided.		
RUN output (See note 1.)		Contact configuration: SPST-NO Switch capacity: 240 V AC, 2 A (resistive load) 120 V AC, 0.5 A (induction load) 24 V DC, 2 A (resistive load) 24 VDC, 2 A (induction load)	Not provided.	
Insulation resistance		20 MΩ min. (at 500 V DC) between AC external and GR terminals (See note 2.)	20 MΩ min. (at 500 V DC) between DC external and GR terminals (See note 2.)	
Dielectric strength		Between AC external and GR terminals (See note 2.): 2,300 V AC 50/60 Hz for 1 min Leakage current: 10 mA max. Between DC external and GR terminals (See note 2.): 1,000 V AC 50/60 Hz for 1 min Leakage current: 10 mA max.	Between DC external and GR terminals (See note 2.): 1,000 V AC 50/60 Hz for 1 min Leakage current: 10 mA max.	
Noise immunity		2 kV on power supply line (conforming to IEC61000-4-4)		
Vibration resistance		10 to 57 Hz, 0.075-mm amplitude, 57 to 150 Hz, acceleration: 9.8 m/s ² in X, Y, and Z directions for 80 minutes (Time coefficient: 8 minutes × coefficient factor 10 = total time 80 minutes) (When mounted on a DIN Track: 2 to 55 Hz, acceleration of 2.9 m/s ² in X, Y, and Z directions for 20 minutes) (conforming to IEC60068-2-6)		
Shock resistance		147 m/s ² 3 times each in X, Y, and Z directions (conforming to IEC60068-2-27)		
Ambient operating temperature		0 to 55°C		
Ambient operating humidity		10% to 90% (with no condensation)		
Atmosphere		No corrosive gases		
Ambient storage temperature		-20 to 75°C (excluding battery)		
Grounding		Less than 100 Ω		
Enclosure		Mounted in a panel.		
Weight		Each Rack: 6 kg max.		
CPU Rack dimensions (mm)		CS1D-BC052 (5 slots, Duplex CPU System) and CS1D-BI082S (8 slots, Single CPU System): 505 × 132 × 123 mm (W × H × D) (See note 2.)		

Note: 1. Supported when mounted to a Backplane.

2. Disconnect the CS1D Power Supply Unit's LG terminal from the GR terminal when testing insulation and dielectric strength. Testing the insulation and dielectric strength with the LG terminal and the GR terminals connected will damage internal circuits in the CPU Unit.

CPU Units

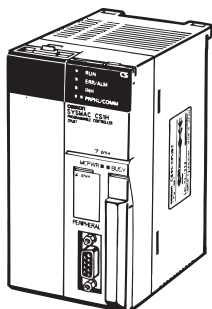

CS1D CPU Unit
(For a Duplex CPU System)

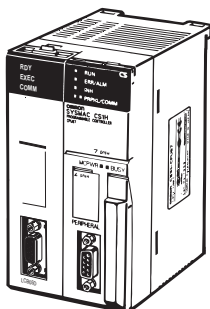

Process-control CPU Unit

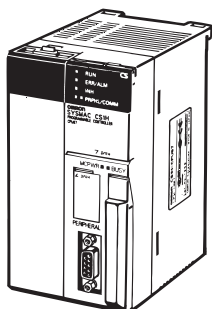

CS1D CPU Unit
(For a Single CPU System)

Item	CS1D CPU Unit								
	CS1D-H CPU Unit (For Duplex CPU Systems)		Process-control CPU Unit		CS1D-H CPU Unit (For Single CPU Systems)				
Model number	CS1D-CPU67H	CS1D-CPU65H	CS1D-CPU67P	CS1D-CPU65P	CS1D-CPU67S	CS1D-CPU65S	CS1D-CPU44S	CS1D-CPU42S	
CPU Unit duplexing	Can be duplexed.				Cannot be duplexed.				
Number of I/O points	5,120 points						1,280 points	960 points	
Number of Expansion Racks	7 max.						3 max.	2 max.	
User program capacity	250 Ksteps	60 Ksteps	250 Ksteps	60 Ksteps	250 Ksteps	60 Ksteps	30 Ksteps	10 Ksteps	
Data memory	448 Kwords	128 Kwords	448 Kwords	128 Kwords	448 Kwords	128 Kwords	64 Kwords	64 Kwords	
DM	32 Kwords	32 Kwords	32 Kwords	32 Kwords	32 Kwords	32 Kwords	32 Kwords	32 Kwords	
EM	32 Kwords × 13 banks	32 Kwords × 3 banks	32 Kwords × 13 banks	32 Kwords × 3 banks	32 Kwords × 13 banks	32 Kwords × 3 banks	32 Kwords × 1 bank	32 Kwords × 1 bank	
LD instruction execution time	0.02 μs						0.04 μs		
Interrupt functions	Cannot be used.				Can be used.				
Loop control functions	None		Yes (Can be duplexed.)		Yes, when a Loop Control Board is installed				
Current consumption (A)	5 V	0.82 (See notes 1 and 2.)	0.82 (See notes 1 and 2.)	1.04	1.04	0.82 (See note 1.)	0.82 (See note 1.)	0.78 (See note 1.)	0.78 (See note 1.)
	26 V	---	---	---	---	---	---	---	---
Standards	UC1, N, L, CE		UC1, N, CE		UC1, N, L, CE				

Note: 1. These values include the current consumption of a connected Programming Console.
 2. NT-AL001 Link Adapters consume an additional 0.15 A each when used.

Common Specifications

Item		Specifications	
Control method		Stored program	
I/O control method		Cyclic scan and immediate processing are both supported.	
Programming		Ladder diagram	
Instruction length		1 to 7 steps per instruction	
Ladder instructions		Approx. 400 (3-digit function codes)	
Instruction execution times	Basic instructions	0.02 μs min.	
	Special instructions	0.04 μs min.	
Number of Tasks		288 (256 of these tasks are shared with interrupt tasks) Note: 1. Cyclic tasks are executed each cycle and are controlled with TKON(820) and TKOF(821) instructions. 2. The following 4 types of interrupt tasks are supported in CS1D-CPU□□S CPU Units for Single CPU Systems. (Interrupt tasks are not supported in the CS1D-CPU□□H CPU Units, which are for Duplex CPU Systems.) Power OFF interrupt tasks: 1 max. Scheduled interrupt tasks: 2 max. I/O interrupt tasks: 32 max. External interrupt tasks: 256 max.	
Interrupt types Note: The interrupts can be used in CS1D-CPU□□S CPU Units only.		Scheduled Interrupts: Interrupts generated by the CPU Unit's built-in timer at regular intervals. I/O Interrupts: Interrupts from Interrupt Input Units Power OFF Interrupts: Interrupts executed when the CPU Unit's power is turned OFF. External I/O Interrupts: Interrupts from the Special I/O Units, CS-series CPU Bus Units, or the Inner Board.	
Function blocks		Not supported.	
CIO (Core I/O) Area	I/O Area	5,120: CIO 000000 to CIO 031915 (320 words from CIO 0000 to CIO 0319)	These words can be used as work words if they are not used for their specified purpose.
	Data Link Area	3,200 (200 words): CIO 10000 to CIO 119915 (words CIO 1000 to CIO 1199) Link bits are used for data links and are allocated to Units in Controller Link Systems.	
	CPU Bus Unit Area	6,400 (400 words): CIO 150000 to CIO 189915 (words CIO 1500 to CIO 1899) These words are allocated to CS1 CPU Bus Units.	
	Special I/O Unit Area	15,360 (960 words): CIO 200000 to CIO 295915 (words CIO 2000 to CIO 2959) These words are allocated to CS1 Special I/O Units.	
	Inner Board Area	1,600 (100 words): CIO 190000 to CIO 199915 (words CIO 1900 to CIO 1999) Inner Board bits can be allocated to Inner Boards.	
	SYSMAC BUS Area	800 (50 words): CIO 300000 to CIO 304915 (words CIO 3000 to CIO 3049) (Can be used as work words in the program.)	
	I/O Terminal Area	512 (32 words): CIO 310000 to CIO 313115 (words CIO 3100 to CIO 3131) (Can be used as work words in the program.)	
Work Areas	Internal I/O Area	4,800 (300 words): CIO 120000 to CIO 149915 (words CIO 1200 to CIO 1499) 37,504 (2,344 words): CIO 380000 to CIO 614315 (words CIO 3800 to CIO 6143) These bits in the CIO Area are used as work bits in programming to control program execution. They cannot be used for external I/O.	
	Work Area	8,192 bits (512 words): W00000 to W51115 (W000 to W511) These bits are used to control the programs only. (I/O from external I/O is not possible.)	
Holding Area		8,192 bits (512 words): H00000 to H51115 (H000 to H511) Holding bits are used to control the execution of the program, and maintain their ON/OFF status when the PLC is turned OFF or the operating mode is changed.	
Auxiliary Area		Read only: 7,168 bits (448 words): A00000 to A44715 (words A000 to A447) Read/write: 8,192 bits (512 words): A44800 to A95915 (words A448 to A959) Auxiliary bits are allocated for specific functions.	
Temporary Relay (TR) Area		16 bits (TR0 to TR15) Temporary bits are used to temporarily store the ON/OFF execution conditions at program branches.	
Timer Area		4,096: T0000 to T4095 (used for timers only)	
Counter Area		4,096: C0000 to C4095 (used for counters only)	
Data Memory (DM) Area		32 Kwords: D00000 to D32767 Special I/O Unit DM Area: D20000 to D29599 (100 words × 96 Units) Used to set parameters for Special I/O Units. CPU Bus Unit DM Area: D30000 to D31599 (100 words × 16 Units) Used to set parameters for CPU Bus Units. Inner Board DM Area: D32000 to D32099 Used to set parameters for Inner Boards (Single CPU Systems only). Used as a general-purpose data area for reading and writing data in word units (16 bits). Words in the DM Area maintain their status when the PLC is turned OFF or the operating mode is changed.	
Extended Data Memory (EM) Area		32 Kwords per bank, 13 banks max.: E0_00000 to EC_32767 max. (Not available on some CPU Units.) Used as a general-purpose data area for reading and writing data in word units (16 bits). Words in the EM Area maintain their status when the PLC is turned OFF or the operating mode is changed.	
Data Registers		DR0 to DR15 Used to offset the PLC memory addresses in Index Registers when addressing words indirectly. (Data registers can be set to be used independently by each task. One register is 16 bits (1 word).)	
Index Registers		IR0 to IR15 Store PLC memory addresses for indirect addressing. One register is 32 bits (2 words).	

Item	Specifications				
Task Flags	32 (TK0000 to TK0031) Task Flags are read-only flags that are ON when the corresponding cyclic task is executable and OFF when the corresponding task is not executable or in standby status.				
Trace Memory	4,000 words (The maximum amount of data that can be traced in a data trace is 500 samples for 31 bits and 6 words.)				
File Memory	Memory Cards: A 128MB OMRON Memory Card can be used (MS-DOS format). EM file memory: The EM Area can be converted to file memory (MS-DOS format).				
Functions	Parallel Processing Mode	Program execution and peripheral servicing can be performed simultaneously (CS1D-CPU□□S only).			
	Battery-free operation	The user program and the system's parameters are backed up automatically in flash memory, which is standard equipment.			
	Constant cycle time	1 to 32,000 ms (Unit: 1 ms)			
	Cycle time monitoring	Possible (Unit stops operating if the cycle is too long): 10 to 40,000 ms (Unit: 10 ms)			
	I/O refreshing	Cyclic refreshing, immediate refreshing (See note 1.), refreshing with I/O REFRESH instruction			
	I/O memory holding when changing operating modes	Possible (Depends on the ON/OFF status of the IOM Hold Bit in the Auxiliary Area.)			
	Load OFF	All outputs on Output Units can be turned OFF.			
	Input response time setting	Time constants can be set for inputs from Basic I/O Units. The time constant can be increased to reduce the influence of noise and chattering or it can be decreased to detect shorter pulses on the inputs (CS1 Basic I/O Units only).			
	Startup mode setting	Supported.			
	Memory Card functions	Automatically reading programs (autoboot) from the Memory Card when the power is turned ON.			
		<table border="1"> <tr> <td>Format in which data is stored in Memory Card</td> <td>User program: Program file format PLC Setup and other parameters: Data file format (binary format) I/O memory: Data file format (binary format), text format, or CSV format</td> </tr> <tr> <td>Functions for which Memory Card read/write is supported</td> <td>User program instructions, Programming Devices (including Programming Consoles), Host Link computers</td> </tr> </table>	Format in which data is stored in Memory Card	User program: Program file format PLC Setup and other parameters: Data file format (binary format) I/O memory: Data file format (binary format), text format, or CSV format	Functions for which Memory Card read/write is supported
	Format in which data is stored in Memory Card	User program: Program file format PLC Setup and other parameters: Data file format (binary format) I/O memory: Data file format (binary format), text format, or CSV format			
	Functions for which Memory Card read/write is supported	User program instructions, Programming Devices (including Programming Consoles), Host Link computers			
	Filing	Memory Card data and the EM (Extended Data Memory) Area can be handled as files.			
	Debugging	Control set/reset, differential monitoring, data tracing (scheduled, each cycle, or when instruction is executed), storing location generating error when a program error occurs			
	Online editing	User programs can be overwritten in program-block units when the CPU Unit is in MONITOR or PROGRAM mode. This function is not available for block programming areas.			
	Program protection	Overwrite protection: Set using DIP switch. Copy protection: Password set using Programming Device.			
	Error check	User-defined errors (i.e., user can define fatal errors and non-fatal errors) The FPD(269) instruction can be used to check the execution time and logic of each programming block.			
	Error log	Up to 20 errors are stored in the error log. Information includes the error code, error details, and the time the error occurred.			
	Serial communications	Built-in peripheral port: Programming Device (including Programming Console) connections, Host Links, NT Links Built-in RS-232C port: Programming Device (excluding Programming Console) connections, Host Links, no-protocol communications, NT Links			
	Clock	Provided on all models. Note: Used to store the time when power is turned ON and when errors occur.			
	Power OFF detection time	10 to 25 ms (not fixed)			
	Power OFF detection delay time	0 to 10 ms (user-defined, default: 0 ms)			
Memory retention during power interruptions	Held Areas: Holding bits, contents of Data Memory and Extended Data Memory, and status of the counter Completion Flags and present values. Note: If the IOM Hold Bit in the Auxiliary Area is turned ON, and the PLC Setup is set to maintain the IOM Hold Bit status when power to the PLC is turned ON, the contents of the CIO Area, the Work Area, part of the Auxiliary Area, timer Completion Flags and PVs, Index Registers, and the Data Registers will be saved.				
Power OFF detection delay time	FINS commands can be sent to a computer connected via the Host Link System by executing Network Communications Instructions from the PLC.				
Remote programming and monitoring	Host Link communications can be used for remote programming and remote monitoring through a Controller Link System or Ethernet network.				
Multiple-level communications (See note 2.)	Duplex CPU Systems: 3 levels Single CPU Systems: 8 levels				
Storing comments in CPU Unit	I/O comments can be stored in the CPU Unit in Memory Cards or EM file memory.				
Program check	Program checks are performed at the beginning of operation for items such as no END instruction and instruction errors.				
Control output signals	RUN output: The internal contacts will be ON (closed) while the CPU Unit is operating in RUN mode or MONITOR mode. These terminals are provided only on CS1D-PA207R Power Supply Units.				
Battery service life	The battery life is 5 years at an ambient temperature of 25°C, although the lifetime can be as short as 1.1 years under adverse temperature and power conditions. (Battery Set: CS1W-BAT01) (See note 3.)				
Self-diagnostics	CPU errors (watchdog timer), I/O verification errors, I/O bus errors, memory errors, and battery errors				
Other functions	Words in the Auxiliary Area store the number of power interruptions, time of the last power interruption, and total power ON time.				

- Note:**
1. Immediate refreshing cannot be used in the CS1D-CPU□□H/P CPU Units. (It can be used in the CS1D-CPU□□S CPU Units.)
 2. Communications are possible across up to eight levels only for the Controller Link and Ethernet networks (and the CX-Integrator or CX-Net in CX-Programmer version 4.0 or higher is required to set the routing tables). Communications are possible across only up to three communications levels for the SYSMAC LINK, DeviceNet, and FL-net networks.
 3. Use a replacement battery that was manufactured within the last two years.

Functions Added by Unit Version

■ Function Supported by Unit Version

Function		CPU Unit model number		CS1D-CPU□□H					CS1D-CPU□□S
		System		Duplex CPU, Single I/O Expansion System			Duplex CPU, Dual I/O Expansion System	Single CPU System	
		Unit version		No unit version	Ver. 1.1	Ver. 1.2	Ver. 1.3	Ver. 1.3	Ver. 2.0
Functions unique to CS1D CPU Units	Duplex CPU Units	OK	OK	OK	OK	OK	OK	---	
	Online Unit Replacement using a Programming Device	OK	OK	OK	OK	OK	OK	OK	
	Duplex Power Supply Units	OK	OK	OK	OK	OK	OK	OK	
	Duplex Controller Link Units	OK	OK	OK	OK	OK	OK	OK	
	Duplex Ethernet Units	---	OK	OK	OK	OK	OK	OK	
	Unit Removal without a Programming Device	---	---	OK	OK	OK	OK	---	
	Removal/Addition of Units without a Programming Device (See note 2.)	---	---	---	---	---	OK (See note 2.)	---	
	Duplex Connecting Cables	---	---	---	---	---	OK	---	
	Online Addition of Units and Backplanes	---	---	---	OK (See notes 3 and 4.)	OK (See note 3.)	OK	---	
Online Replacement of Duplex Unit	---	---	---	---	---	OK	---		
Downloading and Uploading Individual Tasks		---	---	---	---	---	---	OK	
Improved Read Protection Using Passwords		---	---	---	---	---	---	OK	
Write Protection from FINS Commands Sent to CPU Units via Networks		---	---	---	---	---	---	OK	
Online Network Connections without I/O Tables		---	---	---	---	---	---	OK	
Communications through a Maximum of 8 Network Levels		---	---	---	---	---	---	OK	
Connecting Online to PLCs via NS-series PTs		---	---	---	---	---	---	OK	
Setting First Slot Words		---	---	---	---	---	---	OK (64 groups max.)	
Automatic Transfers at Power ON without a Parameter File (.STD)		---	---	---	---	---	---	OK	
Automatic Detection of I/O Allocation Method for Automatic Transfer at Power ON		---	---	---	---	---	---	---	
Operation Start/End Times		---	OK	OK	OK	OK	OK	OK	
Automatic Allocation of Communications Ports		---	---	---	OK	OK	OK	OK	
Support of new instructions	MILH, MILR, MILC	---	---	---	---	---	---	OK	
	= DT, <>DT, <DT, <= DT, >DT, >= DT	---	---	---	---	---	---	OK	
	BCMP2	---	---	---	---	---	---	OK	
	GRY	---	---	---	---	---	---	OK	
	TPO	---	---	---	---	---	---	OK	
	DSW, TKY, HKY, MTR, 7SEG	---	---	---	---	---	---	OK	
	EXPLT, EGATR, ESATR, ECHRD, ECHWR	---	---	---	---	---	---	OK	
	IORD/IOWR reading/writing to CPU Bus Units	---	---	---	---	---	---	OK	
	PRV2	---	---	---	---	---	---	---	

Note: 1. OK: Supported, ---: Not supported

- The Removal/Addition of Units without a Programming Device function is supported only by CS1D CPU Units with unit version 1.3 or later and a Duplex CPU, Dual I/O Expansion System. If the Removal/Addition of Units without a Programming Device function is selected in a Duplex CPU, Single I/O Expansion System, the function operates as the earlier Unit Removal without a Programming Device function.
- Basic I/O Units and Special I/O Units can be added for the Online Addition of Units and Backplanes function. CPU Units cannot be added.
- Expansion Backplanes cannot be added with a Duplex CPU, Single I/O Expansion System.

■ Unit Versions and Programming Devices

CPU Unit	Function		CX-Programmer					Programming Console
			Ver. 3.2 or lower	Ver. 3.3	Ver. 4.0 to Ver. 6.0	Ver. 6.1	Ver. 7.0 or higher	
CS1D CPU Units for Single CPU Systems, Unit Ver. 2.0	Functions added for unit version 2.0	Using new functions	---	---	OK	OK	OK	No restrictions
		Not using new functions	---	---	OK	OK	OK	
CS1D CPU Units for Duplex CPU Systems, Unit Ver. 1.1	Functions added for unit version 1.1	Using new functions	---	---	OK	OK	OK	
		Not using new functions	OK	OK	OK	OK	OK	
CS1D CPU Units for Duplex CPU Systems, Unit Ver. 1.2	Functions added for unit version 1.2	Using new functions	---	---	---	OK	OK	
		Not using new functions	OK	OK	OK	OK	OK	
CS1D CPU Units for Duplex CPU Systems, Unit Ver. 1.3	Functions added for unit version 1.3	Using new functions	---	---	---	---	OK	Online addition of Units is not supported.
		Not using new functions	OK	OK	OK	OK	OK	

Note: It is not necessary to upgrade the version of the CX-Programmer if functionality that was enhanced for the upgrade of the CPU Unit will not be used.

Ordering Information

Basic System SYSTEM 1	38
CPU Rack (Duplex CPU, Dual I/O Expansion System)	38
Expansion Racks (Dual I/O Expansion System)	39
Basic System SYSTEM 2	40
CPU Rack (Duplex CPU, Single I/O Expansion System)	40
Expansion Racks (Single I/O or Long-distance Expansion System)	41
Basic System SYSTEM 3	42
CPU Rack (Single CPU System)	42
Expansion Racks (Single I/O or Long-distance Expansion System)	43
Connecting Cables (Compatible with All Systems)	44
Programming Devices.....	45
Accessories and Maintenance Parts	49
Basic I/O Units	50
Special I/O Units, CPU Bus Units, and Inner Boards	53

International Standards

- The standards are abbreviated as follows: U: UL, U1: UL Class 1 Division 2 Products for Hazardous Locations, C: CSA, UC: cULus, UC1: cULus Class 1 Division 2 Products for Hazardous Locations, CU: cUL, N: NK, L: Lloyd, and CE: ED Directives.
- Ask your OMRON representative for the conditions under which the standards were met.

● EC Directives

The EC Directives applicable to PLCs include the EMC Directives and the Low Voltage Directive. OMRON complies with these directives as described below.

● EMC Directives

Applicable Standards

EMI:	EN61000-6-4
	EN61131-2
EMS:	EN61000-6-2
	EN61131-2

PLCs are electrical devices that are incorporated in machines and manufacturing installations. OMRON PLCs conform to the related EMC standards so that the devices and machines into which they are built can more easily conform to EMC standards. The actual PLCs have been checked for conformity to EMC standards. Whether these standards are satisfied for the actual system, however, must be checked by the customer.

EMC-related performance will vary depending on the configuration, wiring, and other conditions of the equipment or control panel in which the PLC is installed. The customer must, therefore, perform final checks to confirm that the overall machine or device conforms to EMC standards.

● Low Voltage Directive

● Applicable Standard

EN61131-2

Devices that operate at voltages from 50 to 1,000 VAC or 75 to 150 VDC must satisfy the appropriate safety requirements. With PLCs, this applies to Power Supply Units and I/O Units that operate in these voltage ranges.

These Units have been designed to conform to EN61131-2, which is the applicable standard for PLCs.

Ordering Information

Basic System

SYSTEM 1 CPU Rack (Duplex CPU, Dual I/O Expansion System)

The CPU Rack requires a CS1D CPU Backplane (for a Duplex CPU, Dual I/O Expansion System), one or two CS1D Power Supply Units, and two CS1D CPU Units (for a Duplex CPU, Dual I/O Expansion System or Single I/O Expansion System). When an Expansion Rack is connected, two I/O Control Units are required.

CS1D CPU Units

Name	Specifications						Current consumption (A)		Model	Standards
	Number of I/O points	Program capacity	Data Memory	LD execution time	Duplex CPUs	Interrupt functions	5 V system	26 V system		
 CS1D CPU Unit for Duplex CPU Systems	5,120 points (7 Racks)	250 Ksteps	448 Kwords (DM: 32 Kwords, EM: 32 Kwords × 13 banks)	0.02 μs	OK	---	0.82 (See note 2.)	---	CS1D-CPU67H	UC1, N, L, CE
		60 Ksteps	128 Kwords (DM: 32 Kwords, EM: 32 Kwords × 3 banks)				0.82 (See note 2.)	---	CS1D-CPU65H	

- Note:**
- The interrupt functions cannot be used in a Duplex CPU, Dual I/O Expansion System.
 - NT-AL001 Link Adapters consume an additional 0.15 A each when used.

CS1D Process-control CPU Units

Name	Specifications		Current consumption (A)		Model	Standards
	CPU section	Loop control section	5 V system	26 V system		
 CS1D Process-control CPU Unit	Equivalent to the CS1D-CPU67H	LCB05D Operation method: Function block method Number of function blocks: 500 blocks max. Minimum operation cycle: 100 ms	1.04	---	CS1D-CPU67P	UC1, N, CE
	Equivalent to the CS1D-CPU65H	PID control method: PID with two degrees of freedom (with autotuning function)	1.04	---	CS1D-CPU65P	

- Note:**
- The CS1W-LCB01/05 Loop Control Boards cannot be used in a CS1D-CPU□□H for Duplex CPU, Dual I/O Expansion Systems. If the system requires duplex Loop Control Boards, use the CS1D-CPU□□P Process-control CPU Units.
 - The interrupt functions cannot be used in a Duplex CPU, Dual I/O Expansion System or Duplex CPU, Single I/O Expansion System.

CS1D Duplex Unit



Name	Specifications			Current consumption (A)		Model	Standards
	Applicable systems	Basic functions	Online Replacement	5 V system	26 V system		
 CS1D Duplex Unit	Duplex CPU, Dual I/O Expansion System only	Duplex CPU Unit processing, error monitoring, and CPU Unit switching when error occurs	Supported	0.41	---	CS1D-DPL02D	UC1, CE

CS1D Power Supply Units

Two Power Supply Units can be mounted in each Backplane (Rack) to duplex the power supplies.

When duplexing the power supplies, always use the same model of CS1D Power Supply Unit (CS1D-P□□□□).

When selecting a Power Supply Unit, verify that one Unit can satisfy the Rack's entire current consumption.

Name	Power supply voltage	Output capacity			Options		Model	Standards
		5 VDC output capacity	26 VDC output capacity	Total	24 V DC service power supply	RUN output		
 AC Power Supply Unit	100 to 120 V AC or 200 to 240 V AC	7 A	1.3 A	35 W	No	Yes	CS1D-PA207R	UC1, N, L, CE
 DC Power Supply Unit	24 V DC	4.3 A	0.56 A	28 W	No	No	CS1D-PD024	
		5.3 A	1.3 A	40 W			CS1D-PD025	

■ CS1D CPU Backplane

Name	Specifications			Current consumption (A)		Model	Standards
	Applicable systems	Number of Power Supply Units	Number of I/O Units	5 V system	26 V system		
CS1D CPU Backplane 	Duplex CPU, Dual I/O Expansion System only	2 Units max. (for duplex operation)	5 Units max. (including the I/O Control Units)	1.20	---	CS1D-BC042D	UC1, CE

Note: C200H-series Units cannot be mounted.

SYSTEM 1 Expansion Racks (Dual I/O Expansion System)

Each Expansion Rack requires a CS1D Expansion Backplane (for a Duplex CPU, Dual I/O Expansion System), one or two CS1D Power Supply Units, and one or two I/O Interface Units.

■ CS1D Expansion Backplane

Name	Specifications			Current consumption (A)		Model	Standards
	Applicable systems	Number of Power Supply Units	Number of I/O Units	5 V system	26 V system		
CS1D Expansion Backplane 	Duplex CPU, Dual I/O Expansion System only	2 Units max. (for duplex operation)	9 Units max. (Slot number 0 is reserved for an I/O Interface Unit.)	1.21	---	CS1D-BI082D	UC1, CE

Note: 1. C200H-series Units cannot be mounted.

2. CS-series CPU Bus Units can be mounted in an Expansion Rack, but the I/O refreshing time is longer than it is when the CPU Bus Unit is mounted in the CPU Rack.

■ I/O Control Unit

When an Expansion Rack is being connected, mount the CS1D-IC102D I/O Control Unit in the left side of the CPU Backplane and connect the Connecting Cable. Two Units can be mounted to duplex the expansion bus.

Name	Specifications					Current consumption (A)		Model	Standards
	Applicable systems	Duplexing	Online Replacement	Mounting Backplane	Connecting Cable	5 V system	26 V system		
I/O Control Unit 	Duplex CPU, Dual I/O Expansion System only	Supported	Supported	Expansion Backplane	CS1W-CN□□3 CS-series Connecting Cable	0.20	---	CS1D-IC102D	UC1, CE

Note: Connecting Cables for Long-distance Racks (CV500-CN□□2) cannot be used.

■ CS1D I/O Interface Unit

When an Expansion Rack is being connected, mount the CS1D-II102D I/O Interface Unit in the left side of the CS1-series Expansion Backplane. Two Units can be mounted to duplex the expansion bus.

Name	Specifications					Current consumption (A)		Model	Standards
	Applicable systems	Duplexing	Online Replacement	Mounting Backplane	Connecting Cable	5 V system	26 V system		
CS1D I/O Interface Unit 	Duplex CPU, Dual I/O Expansion System only	Supported	Supported	CPU Backplane	CS1W-CN□□3 CS-series Connecting Cable	0.22	---	CS1D-II102D	UC1, CE

Note: Connecting Cables for Long-distance Racks cannot be used.

Basic System

SYSTEM 2 CPU Rack (Duplex CPU, Single I/O Expansion System)

The CPU Rack requires a CS1D CPU Backplane (for a Duplex CPU System), one or two CS1D Power Supply Units, and two CS1D CPU Units (for a Duplex CPU System). If the length of the Connecting Cables exceeds 12 m, a Long-distance Expansion System must be used and a Long-distance I/O Control Unit must be mounted.

CS1D CPU Units

Name	Specifications						Current consumption (A)		Model	Standards
	Number of I/O points	Program capacity	Data Memory	LD execution time	Duplex CPUs	Interrupt functions	5 V system	26 V system		
 CS1D CPU Unit for Duplex CPU Systems	5,120 points (7 Racks)	250 Ksteps	448 Kwords (DM: 32 Kwords, EM: 32 Kwords × 13 banks)	0.02 μs	OK	---	0.82 (See note 2.)	---	CS1D-CPU67H	UC1, N, L, CE
		60 Ksteps	128 Kwords (DM: 32 Kwords, EM: 32 Kwords × 3 banks)				0.82 (See note 2.)	---	CS1D-CPU65H	

- Note:**
- The interrupt functions cannot be used in a Duplex CPU System.
 - NT-AL001 Link Adapters consume an additional 0.15 A each when used.

CS1D Process-control CPU Units

Name	Specifications		Current consumption (A)		Model	Standards
	CPU section	Loop control section	5 V system	26 V system		
 CS1D Process-control CPU Unit	Equivalent to the CS1D-CPU67H	LCB05D Operation method: Function block method Number of function blocks: 500 blocks max. Minimum operation cycle: 100 ms	1.04	---	CS1D-CPU67P	UC1, N, CE
	Equivalent to the CS1D-CPU65H	PID control method: PID with two degrees of freedom (with autotuning function)	1.04	---	CS1D-CPU65P	

- Note:**
- The CS1W-LCB01/05 Loop Control Boards cannot be used in a CS1D-CPU□□H for Duplex CPU, Dual I/O Expansion Systems. If the system requires duplex Loop Control Boards, use the CS1D-CPU□□P Process-control CPU Units.
 - The interrupt functions cannot be used in a Duplex CPU System.

CS1D Duplex Unit



Name	Specifications			Current consumption (A)		Model	Standards
	Applicable systems	Basic functions	Online Replacement	5 V system	26 V system		
 CS1D Duplex Unit	Duplex CPU, Single I/O Expansion System only	Duplex CPU Unit processing, error monitoring, and CPU Unit switching when error occurs	Not supported	Total: 0.55	---	CS1D-DPL01	UC1, N, L, CE

CS1D Power Supply Units

Two Power Supply Units can be mounted in each Backplane (Rack) to duplex the power supplies.

When duplexing the power supplies, always use the same model of CS1D Power Supply Unit (CS1D-P□□□□).

When selecting a Power Supply Unit, verify that one Unit can satisfy the Rack's entire current consumption.

Name	Power supply voltage	Output capacity			Options		Model	Standards
		5 VDC output capacity	26 VDC output capacity	Total	24 V DC service power supply	RUN output		
 AC Power Supply Unit	100 to 120 V AC or 200 to 240 V AC	7 A	1.3 A	35 W	No	Yes	CS1D-PA207R	UC1, N, L, CE
 DC Power Supply Unit	24 V DC	4.3 A	0.56 A	28 W	No	No	CS1D-PD024	
		5.3 A	1.3 A	40 W			CS1D-PD025	

■ CS1D CPU Backplane

Name	Specifications			Current consumption (A)		Model	Standards
	Applicable systems	Number of Power Supply Units	Number of I/O Units	5 V system	26 V system		
 CS1D CPU Backplane	Duplex CPU, Single I/O Expansion System only	2 Units max. (for duplex operation)	5 Units max.	Total: 0.55	---	CS1D-BC052	UC1, N, L, CE

Note: C200H-series Units cannot be mounted.

SYSTEM 2 Expansion Racks (Single I/O or Long-distance Expansion System)

Each Expansion Rack requires a CS1D Expansion Backplane (for a Duplex CPU, Single I/O Expansion System), one or two CS1D Power Supply Units, and one or two I/O Interface Units. If the length of the Connecting Cables exceeds 12 m, a Long-distance Expansion System must be used and an I/O Interface Unit must be mounted.

■ CS1D Expansion Backplane

Always use the following Backplane for regular I/O expansion or long-distance expansion.

Name	Specifications			Current consumption (A)		Model	Standards
	Applicable systems	Number of Power Supply Units	Number of I/O Units	5 V system	26 V system		
 CS1D Expansion Backplane	Duplex CPU, Single I/O Expansion System only	2 Units max. (for duplex operation)	9 Units max.	0.28	---	CS1D-BI092	UC1, N, L, CE

Note: 1. C200H-series Units cannot be mounted.

2. CS-series CPU Bus Units can be mounted in an Expansion Rack, but the I/O refreshing time is longer than it is when the CPU Bus Unit is mounted in the CPU Rack.

■ I/O Control Unit

An I/O Control Unit is required only if the length of the Connecting Cables exceeds 12 m. In this case, mount an I/O Control Unit in the CPU Backplane and I/O Interface Units in the CS1 Expansion Backplanes and connect the Racks with Long-distance (CV500-CN□□2) Connecting Cables.

Name	Specifications					Current consumption (A)		Model	Standards
	Applicable systems	Duplexing	Online Replacement	Mounting Backplane	Connecting Cable	5 V system	26 V system		
 I/O Control Unit	Duplex CPU, Single I/O Expansion System or Single CPU System	Not supported	Not supported	CPU Backplane	Long-distance Connecting Cable	0.92	---	CS1W-IC102	U, C, N, L, CE

■ I/O Interface Unit

An I/O Interface Unit is required only if the length of the Connecting Cables exceeds 12 m. In this case, mount I/O Interface Units in the CS1 Expansion Backplanes and connect the Racks with Long-distance (CV500-CN□□2) Connecting Cables.

Name	Specifications					Current consumption (A)		Model	Standards
	Applicable systems	Duplexing	Online Replacement	Mounting Backplane	Connecting Cable	5 V system	26 V system		
 I/O Interface Unit	Duplex CPU, Single I/O Expansion System or Single CPU System	Not supported	Not supported	Expansion Backplane	Long-distance Connecting Cable	0.23	---	CS1W-II102	U, C, N, L, CE

Basic System

SYSTEM 3 CPU Rack (Single CPU System)

The CPU Rack requires a CS1D CPU Backplane (for a Single CPU System), one or two CS1D Power Supply Units, and a CS1D CPU Unit (for a Single CPU System). If the length of the Connecting Cables exceeds 12 m, a Long-distance Expansion System must be used and a Long-distance I/O Control Unit must be mounted.

CS1D CPU Units

Name	Specifications						Current consumption (A)		Model	Standards
	Number of I/O points	Program capacity	Data Memory	LD execution time	Duplex CPUs	Interrupt functions	5 V system	26 V system		
CS1D CPU Unit for Single CPU Systems 	5,120 points (7 Racks)	250 Ksteps	448 Kwords (DM: 32 Kwords, EM: 32 Kwords × 13 banks)	0.02 μs	---	OK	0.82 (See note.)	---	CS1D-CPU67S	UC1, N, L, CE
	5,120 points (7 Racks)	60 Ksteps	128 Kwords (DM: 32 Kwords, EM: 32 Kwords × 3 banks)	0.04 μs			0.82 (See note.)	---	CS1D-CPU65S	
	1,280 points (3 Racks)	30 Ksteps	64 Kwords (DM: 32 Kwords, EM: 32 Kwords × 1 bank)				0.78 (See note.)	---	CS1D-CPU44S	
	960 points (2 Racks)	10 Ksteps	64 Kwords (DM: 32 Kwords, EM: 32 Kwords × 1 bank)				0.78 (See note.)	---	CS1D-CPU42S	



Note: NT-AL001 Link Adapters consume an additional 0.15 A each when used.

CS1D Power Supply Units

Two Power Supply Units can be mounted in each Backplane (Rack) to duplex the power supplies.

When duplexing the power supplies, always use the same model of CS1D Power Supply Unit (CS1D-P□□□□).

When selecting a Power Supply Unit, verify that one Unit can satisfy the Rack's entire current consumption.

Name	Power supply voltage	Output capacity			Options		Model	Standards
		5 VDC output capacity	26 VDC output capacity	Total	24 V DC service power supply	RUN output		
AC Power Supply Unit 	100 to 120 V AC or 200 to 240 V AC	7 A	1.3 A	35 W	No	Yes	CS1D-PA207R	UC1, N, L, CE
DC Power Supply Unit 	24 V DC	4.3 A	0.56 A	28 W	No	No	CS1D-PD024	
		5.3 A	1.3 A	40 W			CS1D-PD025	

CS1D CPU Backplane

Name	Specifications			Current consumption (A)		Model	Standards
	Applicable systems	Number of Power Supply Units	Number of I/O Units	5 V system	26 V system		
CS1D CPU Backplane 	Single CPU System only	2 Units max. (for duplex operation)	8 slots max.	0.17	---	CS1D-BC082S	UC1, N, L, CE

Note: C200H-series Units cannot be mounted.

SYSTEM 3 Expansion Racks (Single I/O or Long-distance Expansion System)

Each Expansion Rack requires a CS1D Expansion Backplane (for a Duplex CPU, Single I/O Expansion System), and one or two CS1D Power Supply Units. If the length of the Connecting Cables exceeds 12 m, a Long-distance Expansion System must be used and an I/O Interface Unit must be mounted.

CS1D Expansion Backplane

Always use the following Backplane for regular I/O expansion or long-distance expansion.

Name	Specifications			Current consumption (A)		Model	Standards
	Applicable systems	Number of Power Supply Units	Number of I/O Units	5 V system	26 V system		
 CS1D Expansion Backplane	Duplex CPU, Single I/O Expansion System or Single CPU System	2 Units max. (for duplex operation)	9 Units max.	0.28	---	CS1D-BI092	UC1, N, L, CE

- Note:**
1. C200H-series Units cannot be mounted.
 2. CS-series CPU Bus Units can be mounted in an Expansion Rack, but the I/O refreshing time is longer than it is when the CPU Bus Unit is mounted in the CPU Rack.

I/O Control Unit (Used for Long-distance Expansion)

An I/O Control Unit is required only if the length of the Connecting Cables exceeds 12 m. In this case, mount an I/O Control Unit in the CPU Backplane and I/O Interface Units in the CS1 Expansion Backplanes and connect the Racks with Long-distance (CV500-CN□□2) Connecting Cables.

Name	Specifications					Current consumption (A)		Model	Standards
	Applicable systems	Duplexing	Online Replacement	Mounting Backplane	Connecting Cable	5 V system	26 V system		
 I/O Control Unit	Duplex CPU, Single I/O Expansion System or Single CPU System	Not supported	Not supported	CPU Backplane	Long-distance Connecting Cable	0.92	---	CS1W-IC102	U, C, N, L, CE

I/O Interface Unit



An I/O Interface Unit is required only if the length of the Connecting Cables exceeds 12 m. In this case, mount I/O Interface Units in the CS1 Expansion Backplanes and connect the Racks with Long-distance (CV500-CN□□2) Connecting Cables.

Name	Specifications					Current consumption (A)		Model	Standards
	Applicable systems	Duplexing	Online Replacement	Mounting Backplane	Connecting Cable	5 V system	26 V system		
 I/O Interface Unit	Duplex CPU, Single I/O Expansion System or Single CPU System	Not supported	Not supported	Expansion Backplane	Long-distance Connecting Cable	0.23	---	CS1W-II102	U, C, N, L, CE

Connecting Cables (Compatible with All Systems)

Connecting Cables are always required when using Expansion Backplanes in a CS1D system.

Long-distance Connecting Cables are required only when connecting Expansion Racks at a long distance in a Duplex CPU, Single I/O Expansion System or Single CPU System.

Name	Specifications			Model	Standards
	Applicable systems	Function	Cable length		
CS1-series Connecting Cables 	All systems other than long-distance systems	Use to connect the expansion bus between the CPU Backplane and CS1 Expansion Backplanes	0.3 m	CS1W-CN313	N, L, CE
			0.7 m	CS1W-CN713	
			2 m	CS1W-CN223	
			3 m	CS1W-CN323	
			5 m	CS1W-CN523	
			10 m	CS1W-CN133	
			12 m	CS1W-CN133-B2	
Long-distance Connecting Cables 	Duplex CPU, Single I/O Expansion Systems or Single CPU Systems (only with long-distance expansion)	In a Long-distance Expansion System, use to connect from the I/O Control Unit to an I/O Interface Unit or between I/O Interface Units.	0.3 m	CV500-CN312	
			0.6 m	CV500-CN612	
			1 m	CV500-CN122	
			2 m	CV500-CN222	
			3 m	CV500-CN322	
			5 m	CV500-CN522	
			10 m	CV500-CN132	
			20 m	CV500-CN232	
			30 m	CV500-CN332	
			40 m	CV500-CN432	
50 m	CV500-CN532				

Programming Devices

Support Software

Product name	Specifications	Model		Standards
		No. of licenses	Media	
FA Integrated Tool Package CX-One Ver. 4.□ The CX-One is a comprehensive software package that integrates Support Software for OMRON PLC's and components. CX-One runs on the following OS. Windows XP (Service Pack 3 or higher, 32-bit version) / Windows Vista (32-bit/64-bit version) / Windows 7 (32-bit/64-bit version) / Windows 8 (32-bit/64-bit version) / Windows 8.1 (32-bit/64-bit version) / Windows 10 (32-bit/64-bit version) CX-One version 4.□ includes CX-Programmer and CX-Simulator. For details, refer to the CX-One Introduction Guide (Cat. No. R134).	---	DVD	CXONE-AL00D-V4	---
	1 license		CXONE-AL01D-V4	
	3 licenses		CXONE-AL03D-V4	
	10 licenses		CXONE-AL10D-V4	
	30 licenses		CXONE-AL30D-V4	
	50 licenses		CXONE-AL50D-V4	

Note: Site licenses are available for users who will run CX-One on multiple computers. Ask your OMRON sales representative for details.

* The CXONE-AL00D-V4 contains only the DVD installation media for users who have purchased the CX-One Version 4.□ and does not include the license number. Enter the license number of the CX-One Version 4.□ when installing. (The license number of the CX-One Version 3.□ or lower cannot be used for installation.)







Support Software in CX-One Ver.4.□

The following tables lists the Support Software that can be installed from CX-One.

Support Software in CX-One	Outline
CX-Programmer	Application software to create and debug programs for SYSMAC CS/CJ/CP/NSJ-series, C-series, and CVM1/C-series CPU Units. Data can be created and monitored for high-speed-type Position Control Units and Position Control Units with EtherCAT interface.
CX-Integrator	Application software to build and set up FA networks, such as Controller Link, DeviceNet, CompoNet, CompoWay, and Ethernet networks. The Routing Table Component and Data Link Component can be started from here. DeviceNet Configuration functionality is also included.
Switch Box Utility	Utility software that helps you to debug PLCs. It helps you to monitor the I/O status and to monitor/change present values within the PLC you specify.
CX-Protocol	Application software to create protocols (communications sequences) between SYSMAC CS/CJ/CP/NSJ-series or C200HX/HG/HE Serial Communications Boards/Units and general-purpose external devices.
CX-Simulator	Application software to simulate SYSMAC CS/CJ/CP/NSJ-series CPU Unit operation on the computer to debug PLC programs without a CPU Unit.
CX-Position	Application software to create and monitor data for SYSMAC CS/CJ-series Position Control Units. (except for High-speed type)
CX-Motion-NCF	Application software to create and monitor data for SYSMAC CS/CJ-series Position Control Units with MECHATROLINK-II interface (NC□71).
CX-Motion-MCH	Application software to create data and monitor program and monitor data SYSMAC CS/CJ-series Motion Control Units with MECHATROLINK-II interface (MCH71).
CX-Motion	Application software to create data for SYSMAC CS/CJ-series, C200HX/HG/HE, and CVM1/CV-series Motion Control Units, and to create and monitor motion control programs.
CX-Drive	Application software to set and control data for Inverters and Servos.
CX-Process Tool	Application software to create and debug function block programs for SYSMAC CS/CJ-series Loop Controllers (Loop Control Units/Boards, Process Control CPU Units, and Loop Control CPU Units).
Faceplate Auto-Builder for NS	Application software that automatically outputs screen data as project files for NS-series PTs from tag information in function block programs created with the CX-Process Tool.
CX-Designer	Application software to create screen data for NS-series PTs.
NV-Designer	Application software to create screen data for NV-series small PTs.
CX-Configurator FDT	Application software for setting various units by installing its DTM module.
CX-Thermo	Application software to set and control parameters in components such as Temperature Control Units.
CX-FLnet	Application software for system setting and monitoring of SYSMAC CS/CJ-series FL-net Units
Network Configurator	Application software for set up and monitor tag datalink for CJ2 (Built-in EtherNet/IP) CPU Units and EtherNet/IP Units.
CX-Server	Middleware necessary for CX-One applications to communicate with OMRON components, such as PLCs, Display Devices, and Temperature Control Units.
Communications Middleware	Middleware necessary to communicate with CP1L CPU Units with built-in Ethernet port.
PLC Tools (Installed automatically.)	A group of components used with CX-One applications, such as the CX-Programmer and CX-Integrator. Includes the following: I/O tables, PLC memory, PLC Setup, Data Tracing/Time Chart Monitoring, PLC Error Logs, File Memory, PLC clock, Routing Tables, and Data Link Tables.

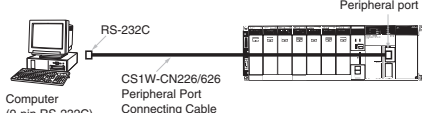
Note: If the complete CX-One package is installed, approximately 4.0 GB of Hard disk space will be required.

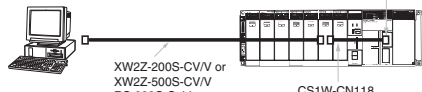
■ Connecting Cables for CX-One Components (e.g. CX-Programmer)

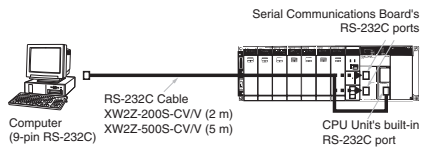
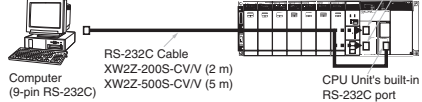
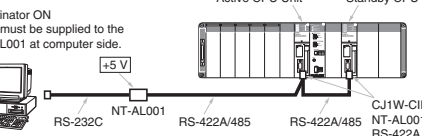
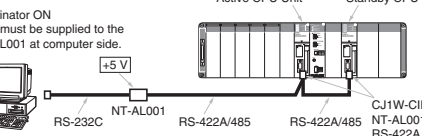

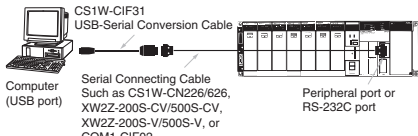
Name	Specifications				Model	Standards
	Applicable computers	Connection configuration	Cable length	Remarks		
Connecting Cables between Programming Device (computer) and peripheral port  	IBM PC/AT or compatible computer (D-Sub 9-pin)	IBM PC/AT or compatible computer ↔ CS1W-CN226/626 ↔ Peripheral port of CPU Unit (See note.)  <p>Note: If the system is a Duplex CPU System, connect to the active CPU Unit.</p>	2 m	Can be used for both peripheral bus and host link.	CS1W-CN226	CE
		The following configuration can be used when using an RS-232C cable to connect to an IBM PC/AT or compatible computer. IBM PC/AT or compatible computer ↔ XW2Z-200S-CV/V or XW2Z-500S-CV/V ↔ Peripheral port of CPU Unit (See note.)  <p>Note: If the system is a Duplex CPU System, connect to the active CPU Unit.</p>	6 m		CS1W-CN626	
		The following configuration can be used when using an RS-232C cable to connect to an IBM PC/AT or compatible computer. IBM PC/AT or compatible computer ↔ XW2Z-200S-CV/V or XW2Z-500S-CV/V ↔ Peripheral port of CPU Unit (See note.)  <p>Note: If the system is a Duplex CPU System, connect to the active CPU Unit.</p>	0.1 m		Use when connecting to the peripheral port with a CXW2Z-200S-CV/V or XW2Z-500S-CV/V RS-232C Cable.	
Connecting Cables between Programming Device (computer) and RS-232C port 	IBM PC/AT or compatible computer (D-Sub 9-pin)	IBM PC/AT or compatible computer ↔ XW2Z-200S-CV/V or XW2Z-500S-CV/V ↔ RS-232C port of CPU Unit (see note 1) or Serial Communications Board/Unit  <p>Note:</p> <ol style="list-style-type: none"> If the system is a Duplex CPU System, connect to the active CPU Unit. We recommend the following configuration if the CX-Programmer is always connected and you want to avoid switching to the other CPU Unit when an error occurs. 	2 m	Can be used for both peripheral bus and host link, and is equipped with an anti-static connector.	XW2Z-200S-CV	---
		IBM PC/AT or compatible computer ↔ XW2Z-200S-CV/V or XW2Z-500S-CV/V ↔ RS-232C port of CPU Unit (see note 1) or Serial Communications Board/Unit  <p>Note:</p> <ol style="list-style-type: none"> If the system is a Duplex CPU System, connect to the active CPU Unit. We recommend the following configuration if the CX-Programmer is always connected and you want to avoid switching to the other CPU Unit when an error occurs. 	5 m		XW2Z-500S-CV	
		IBM PC/AT or compatible computer ↔ XW2Z-200S-CV/V or XW2Z-500S-CV/V ↔ RS-232C port of CPU Unit (see note 1) or Serial Communications Board/Unit  <p>Note:</p> <ol style="list-style-type: none"> If the system is a Duplex CPU System, connect to the active CPU Unit. We recommend the following configuration if the CX-Programmer is always connected and you want to avoid switching to the other CPU Unit when an error occurs. 	2 m		XW2Z-200S-V	
		IBM PC/AT or compatible computer ↔ XW2Z-200S-CV/V or XW2Z-500S-CV/V ↔ RS-232C port of CPU Unit (see note 1) or Serial Communications Board/Unit  <p>Note:</p> <ol style="list-style-type: none"> If the system is a Duplex CPU System, connect to the active CPU Unit. We recommend the following configuration if the CX-Programmer is always connected and you want to avoid switching to the other CPU Unit when an error occurs. 	5 m		XW2Z-500S-V	

Name	Specifications				Model	Standards	
	Applicable computers	Connection configuration	Cable length	Remarks			
USB-Serial Conversion Cable (PC driver CD-ROM included)  Conforms to USB 2.0 Specifications.	IBM PC/AT or compatible computer (USB port)	IBM PC/AT or compatible computer ↔ CS1W-CIF31 ↔ CS1W-CN226/626 ↔ Peripheral port of CPU Unit (See note.)  CS1W-CIF31 USB-Serial Conversion Cable Serial Connecting Cable Such as CS1W-CN226/626, XW2Z-200S-CV/500S-CV, XW2Z-200S-V/500S-V, or CQM1-CIF02 Computer (USB port) Peripheral port or RS-232C port Note: If the system is a Duplex CPU System, connect to the active CPU Unit.	0.5 m	The USB-Serial Conversion Cable connects to the serial connecting cable, which connects to the PLC's peripheral port or RS-232C port.	CS1W-CIF31	N	Can be used for both peripheral bus and host link.
		IBM PC/AT or compatible computer ↔ CS1W-CIF31 ↔ XW2Z-200S-CV/500S-CV ↔ CS1W-CN118 ↔ Peripheral port of CPU Unit					Can be used for both peripheral bus and host link.
		IBM PC/AT or compatible computer ↔ CS1W-CIF31 ↔ XW2Z-200S-V/500S-V ↔ CS1W-CN118 ↔ Peripheral port of CPU Unit					Can be used for host link only. Cannot be used for peripheral bus.
		IBM PC/AT or compatible computer ↔ CS1W-CIF31 ↔ XW2Z-200S-CV/500S-CV ↔ CS1W-CN118 ↔ RS-232C port of CPU Unit or Serial Communications Board/Unit					Can be used for both peripheral bus and host link.
		IBM PC/AT or compatible computer ↔ CS1W-CIF31 ↔ XW2Z-200S-V/500S-V ↔ RS-232C port of CPU Unit or Serial Communications Board/Unit					Can be used for host link only. Cannot be used for peripheral bus.

Note: Either of the serial communications modes listed in the following table can be used to connect CX-One Support Software (e.g., the CX-Programmer) to a CS1-series PLC.

Serial communications mode	Features
Peripheral bus	This mode can provide high-speed communications, so this mode is normally used to connect when using CX-One component software such as the CX-Programmer. <ul style="list-style-type: none"> • Supports 1:1 connections only. • The Programming Device's baud rate can be detected automatically and matched.
Host Link (SYSWAY)	This is a general host computer communications protocol, which supports 1:1 and 1:N connections. <ul style="list-style-type: none"> • Host link operates at a slower speed than peripheral bus. • Host link supports 1:N connections as well as long-distance connections when RS-422A/RS-485 is used for a connection through a modem or optical adapter.

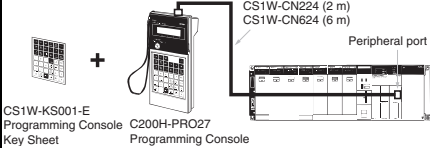
■ Programming Consoles





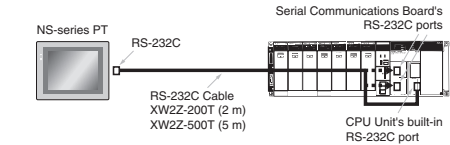
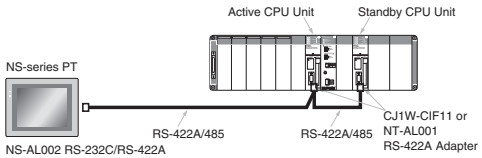

Name	Specifications	Cable model (Separate item)	Connection configuration	Model	Standards
 <p>Programming Console</p>	<p>Can be connected to the CPU Unit's peripheral port only (see note). Cannot be connected to the RS-232C port.</p> <p>A CS1W-KS001-E Programming Console Key Sheet is required (sold separately).</p> <p>Note: If the system is a Duplex CPU System, connect to the active CPU Unit.</p>	<p>CS1W-CN224: 2 m CS1W-CN624: 6 m</p>		C200H-PRO27-E	U, C, N, CE
Programming Console Key Sheet	For the following Programming Consoles: C200H-PRO27			CS1W-KS001-E	CE
Programming Console Connecting Cable		For CQM1-PRO01 connection, Cable length: 0.05 m		CS1W-CN114	
		For C200H-PRO27 connection, Cable length: 2 m		CS1W-CN224	
		For C200H-PRO27 connection, Cable length: 6 m		CS1W-CN624	

■ Connecting Cables for NS-series PTs

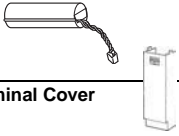
Name	Specifications		Model	Standards	
	Connection configuration				Cable length
 <p>Connecting Cables for NS-series PTs</p>	<p>Connecting Cables between an NS-series PT and the RS-232C port of CPU Unit (see note 1) or Serial Communications Board/Unit</p>  <p>Note: 1. If the system is a Duplex CPU System, connect to the active CPU Unit. 2. We recommend the following configuration if the PT is always connected to a Duplex CPU System for monitoring.</p>  <p>Note: The Converter is not required when connecting to a PT's RS-422A/485 port.</p>		2 m	XW2Z-200T	---
			5 m	XW2Z-500T	
	Connecting Cables between an NS-series PT and the peripheral port of CPU Unit		2 m	XW2Z-200T-2	
			5 m	XW2Z-500T-2	

Accessories and Maintenance Parts



Name	Specifications	Model	Standards
Memory Cards 	Flash Memory, 128 MB	HMC-EF183	---
	Memory Card Adapter (Adapts to a computer's PCMCIA card slot.)	HMC-AP001	CE

Name	Specifications	Model	Standards
Battery Set 	Battery for CS-series maintenance Note: 1. A battery is included with the CPU Unit as standard equipment. 2. The battery life is 5 years at an ambient temperature of 25°C, although the lifetime can be as short as 1.1 years under adverse temperature and power conditions. 3. Use a replacement battery that was manufactured within the last two years.	CS1W-BAT01	---
I/O Terminal Cover 	Cover for 10-pin Terminal Blocks	C200H-COV11	
Connector Cover 	Protective cover for unused Power Supply Unit connector in CS1D Backplane	C500-COV01	
	Protective cover for unused CS-series Unit connector in Backplane	CV500-COV01	
Space Units 	For unused I/O slot spaces In the CS1D-BC□□(S) or CS1D-BI□□□ Backplanes	CS1W-SP001	
	For unused power supply slot spaces (same shape as PA207R)	CS1D-SP001	
	For unused power supply slot spaces (same shape as PD024)	CS1D-SP002	
Programming Console Mounting Bracket 	Use to mount a C200H-PRO27 Programming Console in a control panel.	C200H-ATT01	
Terminator 	Connect a Terminator to the last CS1D Long-distance Expansion Rack in each series (for use with the CS1W-IC102). Two Terminators are included with the CS1W-IC102 I/O Control Unit.	CV500-TER01	U, C
RS-422A Converter	The RS-422A Converter converts RS-232C to RS-422A/RS-485 format.	CJ1W-CIF11	UC1, N, L, CE
RS-232C/RS-422A Link Adapter	One RS-232C port One RS-422 terminal block	NT-AL001	---



Basic I/O Units

Basic I/O Units can be used in all of the CS1D systems: Duplex CPU Dual I/O Expansion System, Duplex CPU Single I/O Expansion System, and Single CPU System. In addition, there are no restrictions on the mounting location based on the type of expansion system being used, except for some special Units such as Interrupt Input Units.



Input Units

Unit type	Name	Specifications		Words required	Current consumption (A)		Model	Standards
		Number of I/O points	Input voltage and current		5 V system	26 V system		
CS1 Basic I/O Unit	 DC Input Unit	16 inputs	24 V DC, 7 mA	1 word	0.10	---	CS1W-ID211	UC1, N, L, CE
		32 inputs	24 V DC, 6 mA	2 words	0.15	---	CS1W-ID231	
		64 inputs	24 V DC, 6 mA	4 words	0.15	---	CS1W-ID261	
		96 inputs	24 V DC, approx. 5 mA	6 words	0.20	---	CS1W-ID291	U, C, N, L, CE
	 AC Input Unit	16 inputs	100 to 120 V AC 100 to 120 V DC	1 word	0.11	---	CS1W-IA111	UC1, N, L, CE
16 inputs		200 to 240 V AC	1 word	0.11	---	CS1W-IA211	UC, N, L, CE	

Output Units

Unit type	Name	Specifications		Words required	Current consumption (A)		Model	Standards		
		Number of I/O points	Switching capacity		5 V system	26 V system				
CS1 Basic I/O Unit	 Relay Output Units	8 outputs	250 V AC or 24 V DC, 2 A max. DC 120V 0.1A Independent contacts	1 word	0.10	0.048 max.	CS1W-OC201	UC1, N, L, CE		
		16 outputs	250 V AC or 24 V DC, 2 A max. 120 V DC, 0.1 A max.	1 word	0.13	0.096 max.	CS1W-OC211			
	 Transistor Output Units	16 outputs	12 to 24 V DC, 0.5 A	Sinking	1 word	0.17	---	CS1W-OD211	U, C, N, L, CE	
			24 V DC, 0.5 A	Sourcing	1 word	0.17	---	CS1W-OD212		
		32 outputs	12 to 24 V DC, 0.5 A	Sinking	2 words	0.27	---	CS1W-OD231		UC1, N, L, CE
			24 V DC, 0.5 A	Sourcing	2 words	0.27	---	CS1W-OD232		
		64 outputs	12 to 24 V DC, 0.3 A	Sinking	4 words	0.39	---	CS1W-OD261		UC1, N, L, CE
			24 V DC, 0.3 A	Sourcing	4 words	0.39	---	CS1W-OD262		
	96 outputs	12 to 24 V DC, 0.1 A	Sinking	6 words	0.48	---	CS1W-OD291	U, C, N, L, CE		
		12 to 24 V DC, 0.1 A	Sourcing	6 words	0.48	---	CS1W-OD292			
	 Triac Output Units	8 outputs	250 V AC, 1.2 A max.		1 word	0.23 max.	---	CS1W-OA201	UC, N, L, CE	
		16 outputs	250 V AC, 0.5 A max.		1 word	0.406 max.	---	CS1W-OA211		

Mixed I/O Units

Unit type	Name	Specifications		Words required	Current consumption (A)		Model	Standards
		Number of I/O points	Input voltage and current, or Switching capacity		5 V system	26 V system		
CS1 Basic I/O Unit	DC Input/Transistor Output Unit 	32 inputs, 32 outputs	Inputs: 24 V DC, 6 mA Outputs: 0.3 A output at 12 to 24 V DC, Sinking	2 input words and 2 output words	0.27	---	CS1W-MD261	UC1, N, L, CE
		32 inputs, 32 outputs	Inputs: 24 V DC, 6 mA Outputs: 0.3 A output at 24 V DC, Sourcing		0.27	---	CS1W-MD262	U, C, N, L, CE
		48 inputs, 48 outputs	Inputs: 24 V DC, approx. 5 mA Outputs: 0.1 A output at 12 to 24 V DC, Sinking	3 input words and 3 output words	0.35	---	CS1W-MD291	
		48 inputs, 48 outputs	Inputs: 24 V DC, approx. 5 mA Outputs: 0.1 A output at 24 V DC, Sourcing		0.35	---	CS1W-MD292	
	TTL I/O Unit 	32 inputs, 32 outputs	5 VDC	2 input words and 2 output words	0.27	---	CS1W-MD561	UC, N, L, CE

Applicable Connectors

Connector for CS1 Basic I/O Units (32 inputs, 64 inputs, 32 outputs, 64 outputs, 32 inputs/32 outputs)

Name	Connection	Applicable Units	Model	Standards
Applicable Connectors	Soldered	FCN-361J040-AU Connector FCN-360C040-J2 Connector cover	C500-CE404 (Included with Unit)	---
	Crimped	FCN-363J040 Housing FCN-363J-AU Contact FCN-360C040-J2 Connector cover	C500-CE405	
	Pressure welded	FCN-367J040-AU/F	C500-CE403	

Connector for CS1 Basic I/O Units (96 inputs, 96 outputs, 48 inputs/48 outputs)

Name	Connection	Applicable Units	Model	Standards
Applicable Connectors	Soldered	FCN-361J056-AU Connector FCN-360C056-J3 Connector cover	CS1W-CE561 (Included with Unit)	---
	Crimped	FCN-363J056 Housing FCN-363J-AU Contact FCN-360C056-J3 Connector cover	CS1W-CE562	
	Pressure welded	FCN-367J056-AU	CS1W-CE563	

Interrupt Input Unit

Unit type	Name	Specifications						Words required	Current consumption (A)		Model	Standards
		Number of I/O points	Voltage	Current	Pulse width of input signal		External connections		5 V system	26 V system		
					ON time	OFF time						
CS1 Basic I/O Unit	Interrupt Input Unit 	16 inputs	24 VDC	7 mA	0.1 ms min.	0.5 ms min.	Removable terminal block	1 word	0.10	---	CS1W-INT01	UC1, N, L, CE

- Note:**
1. An Interrupt Input Unit cannot be used in the CPU Rack of a Duplex CPU System. (The Interrupt Input Unit will function as a standard Input Unit.) An Interrupt Input Unit can be used in the CPU Rack of a Single CPU System to generate interrupt inputs.
 2. An Interrupt Input Unit cannot be used in a CS1D Expansion Rack to generate interrupt inputs. (The Interrupt Input Unit will function as a standard Input Unit.)

■ High-speed Input Unit

Unit type	Name	Specifications					Words required	Current consumption (A)		Model	Standards
		Number of I/O points	Input voltage	Input current	Readable input signal pulse width (ON time)	External connections		5 V system	26 V system		
CS1 Basic I/O Unit	High-speed Input Unit 	16 inputs	24 VDC	7 mA	0.1 ms min.	Removable terminal block	1 word	0.10	---	CS1W-IDP01	UC1, N, L, CE



■ B7A Interface Units

Unit type	Name	Specifications		No. of words allocated	Current consumption (A)		Model	Standards
		I/O points	External connection		5 V system	26 V system		
CS Series Basic I/O Units	B7A Interface Units 	32 inputs	Removable terminal block	2 words	0.09	---	CS1W-B7A12	UC1, CE
		32 outputs		2 words	0.09	---	CS1W-B7A02	
		16 inputs/outputs		2 words	0.09	---	CS1W-B7A21	
		32 inputs/outputs		4 words	0.09	---	CS1W-B7A22	

Special I/O Units, CPU Bus Units, and Inner Boards

Special I/O Units can be used in all of the CS1D systems: Duplex CPU Dual I/O Expansion System, Duplex CPU Single I/O Expansion System, and Single CPU System. In addition, there are no restrictions on the mounting location based on the type of expansion system being used.

Temperature Sensor Input Units (Process Analog I/O Units)

Unit type	Name	Specifications					Words required	Current consumption (A)		Model	Standards
		Number of inputs	Signal selection	Signal ranges	Conversion speed	External connections		5 V system	26 V system		
CS1 Special I/O Unit	Isolated-type Thermocouple Input Units 	4	4 independent	B, E, J, K, N, R, S, T, U, WRe5-26, PL II, ±100 mV	20 ms/4 inputs, 10 ms/2 inputs	Removable terminal block	1 unit number's words	0.12	0.08	CS1W-PTS11	UC1, N, CE
		4	4 independent	R, S, K, J, T, L, B	250 ms/4 inputs			0.25	---	CS1W-PTS51	
		8	8 independent	R, S, K, J, T, L, B	250 ms/8 inputs			0.18	0.06	CS1W-PTS55	
		4	4 independent	B, E, J, K, N, R, S, T, ±80 mV	150 ms/4 inputs			0.15	0.15	CS1W-PTS01-V1	
	Isolated-type Resistance Thermometer Input Units 	4	4 independent	Pt100 Ω (JIS, IEC), JPt100 Ω, Pt150 Ω, Ni100 Ω	20 ms/4 inputs, 10 ms/2 inputs			0.12	0.07	CS1W-PTS12	UC1, N, CE
		4	4 independent	Pt100 Ω (JIS, IEC), JPt100 Ω	250 ms/4 inputs			0.25	---	CS1W-PTS52	
		8	8 independent	Pt100 Ω (JIS, IEC), JPt100 Ω	250 ms/8 inputs			0.18	0.06	CS1W-PTS56	
		4	4 independent	Pt100 Ω (JIS, IEC), JPt100 Ω	100 ms/4 inputs			0.15	0.15	CS1W-PTS02	
	Isolated-type Resistance Thermometer Input Unit (Ni508.4 Ω)	4	4 independent	Ni508.4 Ω	100 ms/4 inputs			0.15	0.15	CS1W-PTS03	

Analog Input Units

Analog Input Units

Unit type	Name	Specifications						Words required	Current consumption (A)		Model	Standards
		I/O points	Signal selection	Signal ranges	Resolution	Conversion speed	External connections		5 V system	26 V system		
CS1 Special I/O Unit	Analog Input Units 	4 inputs	4 independent	1 to 5 V, 0 to 5 V, 0 to 10 V, -10 to 10 V, 4 to 20 mA	1/8,000 (Can also be set to 1/4,000.)	250 μs/input (Can also be set to 1 ms/input.)	Removable terminal block	1 unit number's words	0.12	0.09	CS1W-AD041-V1	UC1, N, CE
		8 inputs	8 independent	1 to 5 V, 0 to 5 V, 0 to 10 V, -10 to 10 V, 4 to 20 mA	1/8,000 (Can also be set to 1/4,000.)	250 μs/input (Can also be set to 1 ms/input.)			0.12	0.09	CS1W-AD081-V1	
		16 inputs	16 independent	1 to 5 V, 0 to 5 V, 0 to 10 V, -10 to 10 V, 4 to 20 mA	1/8,000 (Can also be set to 1/4,000.)	250 μs/input (Can also be set to 1 ms/input.)	MIL connector	2 unit numbers' words	0.15	0.06	CS1W-AD161	
	Connector-Terminal Block Conversion Unit	For CS1W-AD161										XW2D-34G6
										XW2Z-200C		

Process Analog Input Units such as Isolated-type DC Input Units

Unit type	Name	Specifications				Words required	Current consumption (A)		Model	Standards
		Number of inputs	Signal ranges	Conversion speed	External connections		5 V system	26 V system		
CS1 Special I/O Unit	Isolated-type DC Input Units 	4	4 to 20 mA, 0 to 20 mA, 0 to 10 V, ±10 V, 0 to 5 V, ±5 V, 1 to 5 V, 0 to 1.25 V, ±1.25 V	20 ms/4 inputs, 10 ms/2 inputs	Removable terminal block	1 unit number's words	0.12	0.12	CS1W-PDC11	UC1, N, CE
		8	4 to 20 mA, 0 to 10 V, 0 to 5 V, 1 to 5 V,	250 ms/8 inputs			0.18	0.06	CS1W-PDC55	UC1, CE
		4	4 to 20 mA, 0 to 20 mA, 1 to 5 V, 0 to 5 V, ±5 V, 0 to 10 V, ±10 V	100 ms/4 inputs			0.15	0.16	CS1W-PDC01	
	Isolated-type 2-Wire Transmitter Input Unit	4	4 to 20 mA, 1 to 5 V	100 ms/4 inputs			0.15	0.16	CS1W-PTW01	
	Power Transducer Input Unit	8	0 to 1 mA, ±1 mA	200 ms/8 inputs			0.15	0.08	CS1W-PTR01	
	DC Analog Input Unit (100 mV)	8	0 to 100 mV, ±100 mV	200 ms/8 inputs			0.15	0.08	CS1W-PTR02	

■ Analog Output Units

Analog Output Units

Unit type	Name	Specifications					Words required	Current consumption (A)		Model	Standards	
		Number of outputs	Signal selection	Signal ranges	Resolution	Conversion speed		External connections	5 V system			26 V system
CS1 Special I/O Unit	Analog Output Units 	4	4 independent	1 to 5 V, 0 to 5 V, 0 to 10 V, -10 to 10 V, 4 to 20 mA	1/4,000	1 ms/output	Removable terminal block	1 unit number's words	0.13	0.18	CS1W-DA041	UC1, N, L, CE
		8	8 independent	1 to 5 V, 0 to 5 V, 0 to 10 V, -10 to 10 V	1/4,000	1 ms/output			0.13	0.18	CS1W-DA08V	
		8	8 independent	4 to 20 mA	1/4,000	1 ms/output			0.13	0.25	CS1W-DA08C	

Isolated-type Control Output Units (Process Analog I/O Units)

Unit type	Name	Specifications				Words required	Current consumption (A)		Model	Standards	
		Number of outputs	Signal selection	Signal ranges	Conversion speed		External connections	5 V system			26 V system
CS1 Special I/O Unit	Isolated-type Control Output Unit 	4	4 independent	4 to 20 mA, 1 to 5 V	100 ms/4 outputs	Removable terminal block	1 unit number's words	0.15	0.16	CS1W-PMV01	UC1, CE
		4	4 independent	0 to 10 V, ±10 V, 0 to 5 V, ±5 V, 0 to 1V, ±1 V	40 ms/4 outputs			0.12	0.12	CS1W-PMV02	

■ Analog I/O Unit

Unit type	Name	Specifications					Words required	Current consumption (A)		Model	Standards	
		I/O points	Signal selection	Signal ranges	Resolution	Conversion speed		External connections	5 V system			26 V system
CS1 Special I/O Unit	Analog I/O Unit 	4 inputs	4 independent	1 to 5 V, 0 to 5 V, 0 to 10 V, -10 to 10 V, 4 to 20 mA	1/4,000	1 ms/input	Removable terminal block	1 unit number's words	0.20	0.20	CS1W-MAD44	UC1, N, L, CE
		4 outputs			1/4,000	1 ms/output						

■ Isolated-type Pulse Input Unit (Process Analog I/O Unit)

Unit type	Name	Specifications						Words required	Current consumption (A)		Model	Standards
		Number of inputs	Input type selection	Pulse input types	Highest input rate	Accumulation conversion period	External connections		5 V system	26 V system		
CS1 Special I/O Unit	Isolated-type Pulse Input Unit 	4	4 independent	Voltage input, no-voltage semiconductor input, and contact input	0 to 20,000 pulses/s or 0 to 20 pulses/s	100 ms/4 inputs	Removable terminal block	1 unit number's words	0.20	0.16	CS1W-PPS01	UC1, CE

■ Loop Control Boards and Loop Control Units

Unit type	Name	Specifications	Words required	Current consumption (A)		Model	Standards
				5 V system	26 V system		
CS1 Inner Board (See note 1.)		LCB01 Operation method: Function block method Number of function blocks: 50 blocks max. (total control blocks and operation blocks) Minimum operation cycle: 10 ms PID control method: PID with two degrees of freedom (with autotuning function)	---	0.22 (See note 2.)	---	CS1W-LCB01	UC1, N, CE
		LCB05 Operation method: Function block method Number of function blocks: 500 blocks max. (total control blocks and operation blocks) Minimum operation cycle: 10 ms PID control method: PID with two degrees of freedom (with autotuning function)		0.22 (See note 2.)	---	CS1W-LCB05	
Support Software	CX-One FA Integrated Tool Package Ver. 4.□	The CX-One is a comprehensive software package that integrates Support Software for OMRON PLCs and components. CX-One runs on the following OS. Windows XP (Service Pack 3 or higher, 32-bit version) / Windows Vista (32-bit/64-bit version) / Windows 7 (32-bit/64-bit version) / Windows 8 (32-bit/64-bit version) / Windows 8.1 (32-bit/64-bit version) / Windows 10 (32-bit/64-bit version) Note: Except for Windows XP 64-bit version CX-One Ver. 4.□ includes CX-Process Tool Ver. 5.□ and NS-series Face Plate Auto Builder Ver. 3.□ For details, refer to the CX-One catalog (Cat. No. R134).	1 license Media: DVD (See notes 3.)			CXONE-AL01D-V4	---

- Note:**
1. A CS1 Inner Board can be mounted only to the Inner Board mounting slot in the CPU Unit of a Single-CPU System. Only one CS1 Inner Board can be mounted.
 2. NT-AL001 Link Adapters consume an additional 0.15 A each when used.
 3. The CXONE-AL00D-V4 contains only the DVD installation media for users who have purchased the CX-One Version 4.□ and does not include the license number. Enter the license number of the CX-One Version 4.□ when installing. (The license number of the CX-One Version 3.□ or lower cannot be used for installation.)

■ High-speed Counter Units

Unit type	Name	Number of count channels	Encoder A and B inputs, and Z pulse input signal	Maximum count speed	Words required	Current consumption (A)		Model	Standards
						5 V system	26 V system		
CS1 Special I/O Unit	High-speed Counter Units 	2	Open collector Input voltage: 5 V DC, 12 V DC, or 24 V DC (only 1 axis for 5 V or 12 V input)	50 kHz	4 unit numbers' words	0.36	---	CS1W-CT021	UC, N, L, CE
			RS-422 line driver	500 kHz					
		4	Open collector Input voltage: 5 V DC, 12 V DC, or 24 V DC (up to 2 axes for 5 V or 12 V input)	50 kHz		0.45	---	CS1W-CT041	
			RS-422 line driver	500 kHz					

■ Customizable Counter Units

Unit type	Name	Specifications		Words required	Current consumption (A)		Model	Standards
					5 V system	26 V system		
CS1 Special I/O Unit	Customizable Counter Units 	Two-axis pulse input Two-axis pulse output	12 DC inputs 8 transistor outputs	1 unit number's words	0.80	---	CS1W-HCP22-V1	U, C, CE
		Single-axis pulse input 1 analog input 2 analog outputs	12 DC inputs 8 transistor outputs					
		Two-axis pulse input 2 analog outputs	12 DC inputs 8 transistor outputs		0.75	0.15	CS1W-HCA22-V1	
		---	12 DC inputs 8 transistor outputs		0.60	---	CS1W-HIO01-V1	

■ Position Control Units

Unit type	Name	Specifications			Words required	Current consumption (A)		Model	Standards
		Number of axes	Control output interface			5 V system	26 V system		
CS1 Special I/O Unit	Position Control Unit 	1	Pulse-train, open-collector outputs		1 unit number's words	0.25	---	CS1W-NC113	U, C, N, L, CE
		2				0.25	---	CS1W-NC213	
		4			2 unit numbers' words	0.36	---	CS1W-NC413	
		1	Pulse-train, line-driver outputs			1 unit number's words	0.25	---	
		2			0.25		---	CS1W-NC233	
		4			2 unit numbers' words	0.36	---	CS1W-NC433	
Relay Unit for Servo	For use with the CS1W-NC1□3	Number of axes supported: 1						XW2B-20J6-1B	---
	For use with the CS1W-NC2□3/NC4□3	Number of axes supported: 2					XW2B-40J6-2B		
	For use with the CS1W-NC□□3	Number of axes supported: 2, with communications support					XW2B-40J6-4A		
Servo Relay Unit Connecting Cable (Position Control Unit end)	Open-collector output	For use with the CS1W-NC113	Connectable Servo Drive: G5 Series, G Series, W Series *, or SMARTSTEP 2	Number of axes supported: 1	Cable length: 0.5 m		XW2Z-050J-A6		
					Cable length: 1 m		XW2Z-100J-A6		
					Cable length: 0.5 m		XW2Z-050J-A8		
		Cable length: 1 m		XW2Z-100J-A8					
		For use with the CS1W-NC213/NC413		Connectable Servo Drive: G5 Series, G Series, W Series *, or SMARTSTEP 2	Number of axes supported: 2	Cable length: 0.5 m		XW2Z-050J-A7	
						Cable length: 1 m		XW2Z-100J-A7	
	Cable length: 0.5 m		XW2Z-050J-A9						
	Cable length: 1 m		XW2Z-100J-A9						
	Line-driver outputs	For use with the CS1W-NC133	Connectable Servo Drive: G5 Series, G Series, W Series *, or SMARTSTEP 2	Number of axes supported: 1	Cable length: 0.5 m		XW2Z-050J-A10		
					Cable length: 1 m		XW2Z-100J-A10		
					Cable length: 0.5 m		XW2Z-050J-A12		
		Cable length: 1 m		XW2Z-100J-A12					
For use with the CS1W-NC233/NC433		Connectable Servo Drive: G5 Series, G Series, W Series *, or SMARTSTEP 2		Number of axes supported: 2	Cable length: 0.5 m		XW2Z-050J-A11		
					Cable length: 1 m		XW2Z-100J-A11		
	Cable length: 0.5 m		XW2Z-050J-A13						
Cable length: 1 m		XW2Z-100J-A13							

* W-series in the discontinuation model in March 2013.

MECHATROLINK-II-compatible Position Control Unit

Unit type	Name	Specifications		Words required	Current consumption (A)		Model	Standards
					5 V system	26 V system		
CS1 CPU Bus Unit	Position Control Unit 	2 axes	Control commands are sent using MECHATROLINK-II communications. Direct operation from ladder program. Control modes: Position control, speed control, and torque control	1 unit number's words	0.36	---	CS1W-NC271	UC1, CE
		4 axes					CS1W-NC471	
		6 axes					CS1W-NCF71	
	MECHATROLINK-II Cables	MECHATROLINK-II Cables (without ring core and USB connector on both ends) Note: Can be connected to R88D-GN and R88D-KN only.		Cable length: 0.5 m		FNY-W6002-A5		---
				Cable length: 1 m		FNY-W6002-01		
				Cable length: 3 m		FNY-W6002-03		
				Cable length: 5 m		FNY-W6002-05		
		MECHATROLINK-II Cables (with ring core and USB connector on both ends) (Yaskawa Electric Corporation) Use the model numbers provided in this catalog when ordering from OMRON.		Cable length: 0.5 m		FNY-W6003-A5		
				Cable length: 1 m		FNY-W6003-01		
				Cable length: 3 m		FNY-W6003-03		
				Cable length: 5 m		FNY-W6003-05		
				Cable length: 10 m		FNY-W6003-10		
				Cable length: 20 m		FNY-W6003-20		
				Cable length: 30 m		FNY-W6003-30		
				MECHATROLINK-II Terminating Resistors Terminating Resistor for MECHATROLINK-II (Yaskawa Electric Corporation) Use the model numbers provided in this catalog when ordering from OMRON.				
MECHATROLINK-II Repeater For more than 15 slaves/30 m (Yaskawa Electric Corporation)				JEPMC-REP2000-E				



Motion Control Units

Unit type	Name	Specifications		Words required	Current consumption (A)		Model	Standards
					5 V system	26 V system		
CS1 Special I/O Unit	Motion Control Units 	4 axes	G-language programming, analog outputs	5 unit numbers' words	0.70 (1.00 A when a Teaching Box is connected)	---	CS1W-MC421-V1	U, C, CE
		2 axes	G-language programming, analog outputs	3 unit numbers' words	0.60 (0.80 A when a Teaching Box is connected)	---	CS1W-MC221-V1	
	Teaching Box		---				CVM1-PRO01-V1	CE
	Teaching Box Connecting Cable		Cable length: 2 m				CV500-CN224	L, CE
	ROM Cassette (Memory Pack)		---				CVM1-MP702-V1	CE
	MC Terminal Block Conversion Unit for 2 Axes		Simplifies I/O connector wiring.				XW2B-20J6-6	---
	MC Terminal Block Conversion Unit for 4 Axes						XW2B-40J6-7	
	MC Terminal Block Conversion Unit Cable		---				XW2Z-100J-F1	

MECHATROLINK-II-compatible Motion Control Unit

Unit type	Name	Specifications	Words required	Current consumption (A)		Model	Standards	
				5 V system	26 V system			
CS1 CPU Bus Unit	 Motion Control Unit	MECHATROLINK-II Physical axes: 30 axes Virtual axes: 2 axes Special motion control language	1 unit number's words	0.80	---	CS1W-MC271 CS1W-MC471	UC1, CE	
		MECHATROLINK-II Cables	MECHATROLINK-II Cables (without ring core and USB connector on both ends) Note: Can be connected to R88D-GN and R88D-KN only.	Cable length: 0.5 m		FNY-W6002-A5		---
				Cable length: 1 m		FNY-W6002-01		
				Cable length: 3 m		FNY-W6002-03		
				Cable length: 5 m		FNY-W6002-05		
			MECHATROLINK-II Cables (with ring core and USB connector on both ends) (Yaskawa Electric Corporation) Use the model numbers provided in this catalog when ordering from OMRON.	Cable length: 0.5 m		FNY-W6003-A5		
				Cable length: 1 m		FNY-W6003-01		
				Cable length: 3 m		FNY-W6003-03		
				Cable length: 5 m		FNY-W6003-05		
				Cable length: 10 m		FNY-W6003-10		
Cable length: 20 m				FNY-W6003-20				
Cable length: 30 m		FNY-W6003-30						
MECHATROLINK-II Terminator	Terminating resistance for MECHATROLINK-II (Made by Yaskawa Corporation) The model number at the right is used to order from OMRON.			FNY-W6022				
MECHATROLINK-II Repeater	Required for more than 15 slave or 30 m.			FNY-REP2000				
24-VDC I/O Module for MECHATROLINK-II	64 inputs/outputs (Yaskawa Electric Corporation)			JEPMC-IO2310-E				
MECHATROLINK-II Counter Module	Two reversible counters (Yaskawa Electric Corporation)			JEPMC-PL2900-E				
MECHATROLINK-II Pulse Output Module	Pulse-string positioning on two channels (Yaskawa Electric Corporation)			JEPMC-PL2910-E				

Serial Communications Boards/Units

Unit type	Name	Specifications	Words required	Current consumption (A)		Model	Standards	
				5 V system	26 V system			
CS1 Inner Board (See note 1.)	 Serial Communications Board	Two RS-232C ports	The following communications protocols can be selected for each port: protocol macro, host link, NT Link (1:N mode), serial gateway (see note 2), no-protocol (see note 3), or Modbus-RTU Slave (see note 4).	---	0.28 (See note 5.)	---	CS1W-SCB21-V1	U, C, N, L, CE
		One RS-232C port and one RS-422A/485 port		0.36 (See note 5.)	---	CS1W-SCB41-V1		
CS1 CPU Bus Unit	 Serial Communications Unit	Two RS-232C ports		1 unit number's words	0.29 (See note 5.)	---	CS1W-SCU21-V1	
		Two RS-422A/485 ports		0.40	---	CS1W-SCU31-V1	UC1, N, L, CE	

- Note:**
1. A CS1 Inner Board can be mounted only to the Inner Board mounting slot in the CPU Unit of a Single-CPU System. Only one CS1 Inner Board can be mounted.
 2. The serial gateway function is supported by Serial Communications Boards and Units with unit version 1.2 or later only.
 3. The Serial Communications Unit's no-protocol function is supported by Serial Communications Units with unit version 1.2 or later only. In addition the CPU Unit must be unit version 3.0 or later.
 4. The Modbus-RTU Slave function is supported by Serial Communications Boards and Units with unit version 1.3 or later only.
 5. NT-AL001 Link Adapters consume an additional 0.15 A each when used.



■ EtherNet/IP Unit

Unit type	Product name	Specifications		No. of unit numbers allocated	Current consumption (A)		Model	Standards
		Communications cable	Communications functions		5 V system	26 V system		
CS1 CPU Bus Unit	EtherNet/IP Unit 	STP (shielded twisted-pair) cable of category 5, 5e, or higher.	Tag data link message service	1 unit number's words	0.41	---	CS1W-EIP21	UC1, N, L, CE

■ Ethernet Units



Unit type	Name	Specifications				Words required	Current consumption (A)		Model	Standards
		Communications cable	Communications functions	Duplexing	Units per CPU Unit		5 V system	26 V system		
CS1 CPU Bus Unit	Ethernet Units 	100BASE-TX Cable	FINS communications service (TCP/IP and UDP/IP), FTP server function, socket service, mail send service, mail reception (remote command reception), auto-adjustment of PLC's internal clock, and server host name specification	Supported	Not duplexed: 4 Units Duplexed: 4 pairs, 8 Units	1 unit number's words	0.38	---	CS1D-ETN21D	UC1, N, L, CE
				Not supported	4 Units		0.38	---	CS1W-ETN21	U, C, N, L, CE

Industrial Switching Hubs

Product name	Appearance	Specifications			Accessories	Current Consumption(A)	Model	Standards
		Functions	No. of ports	Failure detection				
Industrial Switching Hubs		Quality of Service (QoS): EtherNet/IP control data priority Failure detection: Broadcast storm and LSI error detection 10/100BASE-TX, Auto-Negotiation	3	No	<ul style="list-style-type: none"> Power supply connector 	0.22	W4S1-03B	UC, CE
			5	No		0.22	W4S1-05B	
			5	Yes	<ul style="list-style-type: none"> Power supply connector Connector for informing error 	0.22	W4S1-05C	CE

■ Controller Link Units

Controller Link Units

Unit type	Name	Specifications				Words required	Current consumption (A)		Model	Standards		
		Communications cable	Communications type	Duplexing	Units per CPU Unit		5 V system	26 V system				
CS1 CPU Bus Unit	Controller Link Unit	Wired shielded twisted-pair cable (See note 1.) 	Data links and message service	No	8	1 unit number's words	0.33	---	CS1W-CLK23	UC1, N, L, CE		
		Optical ring H-PCF cable (See note 2.) 		Yes. Unit duplexing and cable loop back are supported.			Non-duplex: 8, Duplex: 11 (6 Units comprising 3 sets of Duplex Units + 5 Non-duplex Units)	0.52			---	CS1W-CLK13
		Optical ring GI cable (See note 3.) 						0.65			---	

Note: 1. Use the following special cable for shielded, twisted-pair cable.

- ESVC0.5 × 2C-13262 (Bando Electric Wire: Japanese Company)
 - ESNCO.5 2C-99-087B (JMACS Japan Co., Ltd.: Japanese Company)
 - ESPC 1P × 0.5m² (Nagaoka Electric Wire Co., Ltd.: Japanese Company)
 - Li2Y-FCY2 × 0.56qmm (Kromberg & Schubert, Komtec Department: German Company)
 - 1 × 2 × AWG-20PE+Tr.CUSN+PVC (Draka Cables Industrial: Spanish Company)
 - #9207 (Belden: US Company)
- 2.** When using a wire-to-optical (H-PCF) cable, use a H-PCF cable (for both Controller Link and SYSMAC LINK) or a H-PCF optical fiber cable with connector.
- 3.** When using a wire-to-optical (GI) cable, use a GI optical cable that matches the specifications.

Controller Link Support Boards

Name	Specifications		Accessories	Model	Standards
	Communications cable	Communications type			
Controller Link Support Boards for PCI Bus 	Wired shielded twisted-pair cable (See note 1.)	Data links and message service	<ul style="list-style-type: none"> • CD-ROM × 1 (See note 2.) • Installation Guide (W467) × 1 • Communications Connector × 1 	3G8F7-CLK23-E	CE
	H-PCF optical model			3G8F7-CLK13-E	
	GI optical model			3G8F7-CLK53-E	

- Note:**
- Use the following special cable for shielded, twisted-pair cable.
 - ESVC0.5 × 2C-13262 (Bando Electric Wire: Japanese Company)
 - ESNC0.5 2C-99-087B (JMACS Japan Co., Ltd.: Japanese Company)
 - ESPC 1P × 0.5m² (Nagaoka Electric Wire Co., Ltd.: Japanese Company)
 - Li2Y-FCY2 × 0.56qmm (Kromberg & Schubert, Komtec Department: German Company)
 - 1 × 2 × AWG-20PE+Tr.CUSN+PVC (Draka Cables Industrial: Spanish Company)
 - #9207 (Belden: US Company)
 - The CD-ROM contains FinsGateway Version 2003 (PCI-CLK Edition) and FinsGateway Version 3 (PCI-CLK Edition). Install the software from CD Ver 3.10 or higher if the operating system is Windows 7 (32bit) or Windows Vista. Install FinsGateway version 3 if the operating system is Windows NT 4.0 (Service pack 3 or higher), Windows ME, or Windows 98SE.

Repeater Units

Name	Specifications	Model	Standards
Controller Link Repeater Unit 	Wire-to-Wire Model	CS1W-RPT01	UC1, CE
	Wire-to-Optical (H-PCF) Model (See note 1.)	CS1W-RPT02	
	Wire-to-Optical (GI) Model (See note 2.)	CS1W-RPT03	

Using Repeater Units enables T-branches and long-distance wiring for Wired Controller Link networks, 62-node configurations, and converting part of the network to optical cable.

- Note:**
- When using wire-to-optical (H-PCF) cable, use a H-PCF cable (for both Controller Link and SYSMAC LINK) or a H-PCF optical fiber cable with connector.
 - When using wire-to-optical (GI) cable, use a GI optical cable (for Controller Link).

Relay Terminal Block

Name	Specifications	Model	Standards
Relay Terminal Blocks for Wired Controller Link Units 	Used for Wired Controller Link Units (set of 5)	CJ1W-TB101	---

Controller Link Units can be replaced without stopping the communications of the entire network if a Relay Terminal Block is installed in advance on the Unit in a Wired Controller Link network. Relay Terminal Blocks cannot be used on Controller Link Support Boards.



Duplex Optical Fiber Cable (H-PCF Cable)

Name	Application	Specifications	Model	Standards
Duplex Optical Fiber Cable	CS1W-CLK13 or CS1W-CLK12-V1 * in a CS1D system	H-PCF cable for connecting Duplex Controller Link Units Cable length: 50 cm	CS1D-CN051	---

This cable is used to connect Units in active mode (ACT) and standby mode (STB) in a CS1D Duplex System.

* Discontinuation models in July 2012.

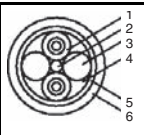
H-PCF Cables (For Controller Link and SYSMAC LINK)



Name	Application and construction	Specifications	Model	Standards	
Optical Fiber Cable	Controller Link SYSMAC LINK SYSBUS  <ol style="list-style-type: none"> 1. Optical fiber single-core cord 2. Tension member (plastic-sheathed wire) 3. Filler (plastic) 4. Filler surrounding signal wires (plastic, yarn, or fiber) 5. Holding tape (plastic) 6. Heat-resistant PV sheath 	Two-core optical cable with tension member	Black 10 m	S3200-HCCB101	---
			Black 50 m	S3200-HCCB501	
			Black 100 m	S3200-HCCB102	
			Black 500 m	S3200-HCCB502	
			Black 1,000 m	S3200-HCCB103	
			Orange 10 m	S3200-HCCO101	
			Orange 50 m	S3200-HCCO501	
			Orange 100 m	S3200-HCCO102	
			Orange 500 m	S3200-HCCO502	
			Orange 1,000 m	S3200-HCCO103	
Optical Connectors (Crimp-cut)	 Controller Link: CS1W-CLK13, CS1W-CLK12-V1 * 3G8F7-CLK13-E, 3G8F7-CLK12-EV1 * CS1W-RPT02 SYSMAC LINK: CS1W-SLK11, 3G8F7-SLK11-E C200HW-SLK13/14 *	Half-lock	S3200-COCF2571	---	
		 Controller Link: CS1W-CLK13, CS1W-CLK12-V1 * 3G8F7-CLK13-E, 3G8F7-CLK12-EV1 * CS1W-RPT02 SYSMAC LINK: 3G8F7-SLK11-E	Full-lock		S3200-COCF2071 (See note.)

Note: Full-lock Optical Connectors (Crimp-cut) (S3200-COCF2071) cannot be used with the CS1W-SLK11. Use a Half-lock Cable (S3200-COCF2571) or a H-PCF Optical Fiber Cable with Connectors (S3200-CN□□□□-□□-□□).

* Discontinuation models.

H-PCF Optical Fiber Cables with Connectors

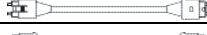
(Black Composite Cables with Two-Optical Lines and Two Power Supply Lines)

Applicable Units	Appearance	Model	Standards
Controller Link SYSMAC LINK		S3200-CN□□□□-20-20	---
		S3200-CN□□□□-20-25	
		S3200-CN□□□□-25-25	

Optical connectors for H-PCF Optical Cables with Connectors are adhesive polished.

Cable Length

The following cable lengths are available: 2 m, 5 m, 15 m, and 20 m. For lengths of 21 m or more, contact your OMRON sales representative.

Model Numbers

(1) 2 m, 5 m, 10 m, 15 m, or 20 m

(2) 21 m or longer

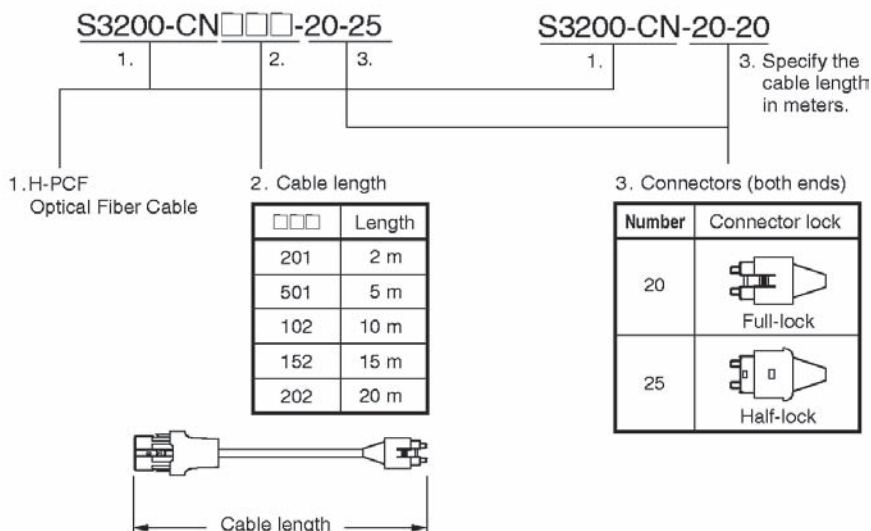

Optical Connector Assembly Tool

Name	Applicable Units	Model	Maker	Standards
Optical Fiber Assembly Tool (See note.)	This tool is used on site for mounting crimp-cut connectors and hard plastic-clad silica optical fiber for optical transmission systems of C-series SYSBUS, SYSMAC LINK, and Controller Link.	CAK-0057	Sumitomo Electric Industries, Ltd.	---

Note: There is a risk of quality problems when using cables assembled by typical users, so we recommend purchasing cables with pre-attached connectors or having a qualified technician assemble the cables.

GI Optical Cables

A qualified technician must select, assemble, and install GI Optical Fiber Cable, so always let an optical cable specialist handle the GI cable.

Usable Optical Fiber Cables and Optical Connectors

- Optical fiber types: Graded, indexed, multi-mode, all quartz glass, fiber (GI-type AGF cable)
- Optical fiber construction (core diameter/clad diameter): 62.5/125 μm or 50/125 μm
- Optical fiber optical characteristics of optical fiber: Refer to the tables.
- Optical connectors: ST connectors (IEC-874-10)

50/125 μm AGF Cables

Items	Minimum	Typical	Maximum	Notes	
Numerical Aperture (N.A)	---	0.21	---	---	
Transmission loss (dB)	---	---	3.0 Lf	0.5 km ≤ Lf	λ = 0.8 μm, Ta = 25°C
			3.0 Lf + 0.2	0.2 km ≤ Lf ≤ 0.5 km	
			3.0 Lf + 0.4	Lf ≤ 0.2 km	
Connection loss (dB)	---	---	1.0	λ = 0.8 μm, one location	
Transmission band width (MHz-km)	500	---	---	λ = 0.85 μm (LD)	



Lf is Fiber length in km, Ta is ambient temperature, and λ is the peak wavelength of the test light source.

62.5/125 μm AGF Cables

Items	Minimum	Typical	Maximum	Notes	
Numerical Aperture (N.A)	---	0.28	---	---	
Transmission loss (dB)	---	---	3.5 Lf	0.5 km ≤ Lf	λ = 0.8 μm, Ta = 25°C
			3.5 Lf + 0.2	0.2 km ≤ Lf ≤ 0.5 km	
			3.5 Lf + 0.4	Lf ≤ 0.2 km	
Connection loss (dB)	---	---	1.0	λ = 0.8 μm, one location	
Transmission band width (MHz-km)	200	---	---	λ = 0.85 μm (LD)	

Lf is Fiber length in km, Ta is ambient temperature, and λ is the peak wavelength of the test light source.

■ SYSMAC LINK Units

Unit type	Name	Specifications				Words required	Current consumption (A)		Model	Standards
		Communications cable	Communications functions	Duplexing	Units per CPU Unit		5 V system	26 V system		
CS1 CPU Bus Unit	SYSMAC LINK Unit 	Coaxial (5C-2V cable)	Data link and message communications functions	Not supported	4	1 unit number's words	0.48	---	CS1W-SLK21	U, C, CE
		Optical (H-PCF cable) (See note.)					0.47	---	CS1W-SLK11	U, C, N, CE
	SYSMAC LINK Support Board, PCI interface 	Coaxial (5C-2V cable)	The 3G8F7-SLK□□ SYSMAC LINK Support Board includes the FinsGateway communications middleware version 3.						3G8F7-SLK21-E	CE
		Optical (H-PCF cable) (See note.)							3G8F7-SLK11-E	
	F Adapter	---	One Adapter is included with each Coaxial-cable SYSMAC LINK Unit/Board.						C1000H-CE001	N
	F Adapter Cover	---							C1000H-COV01	---
Terminator 	---	A Terminator must be installed at each node on the ends of the network.						C1000H-TER01	N	

Note: When using wired optical (H-PCF) communications, use the H-PCF Cable or H-PCF Cable with pre-attached connectors.

■ FL-net Units

Unit type	Name	Specifications				Words required	Current consumption (A)		Model	Standards
		Communications cable	Communications functions	Duplexing	Units per CPU Unit		5 V system	26 V system		
CS1 CPU Bus Unit	FL-net Unit 	100BASE-TX Cable	FL-net (OPCN-2) Ver. 2 specifications Data link and message communications functions	Not supported	4	1 unit number's words	0.38	---	CS1W-FLN22	UC1, CE

■ DeviceNet Unit

Unit type	Name	Specifications				Words required	Current consumption (A)		Model	Standards
		Communications cable	Communications types	Duplexing	Units per CPU Unit		5 V system	26 V system		
CS1 CPU Bus Unit	DeviceNet Unit 	Special DeviceNet cable	<ul style="list-style-type: none"> Remote I/O Master communications (Fixed or user-set allocation) Remote I/O Slave communications (Fixed or user-set allocation) Message communications 	Not supported	16	1 unit number's words	0.29	---	CS1W-DRM21-V1	UC1, N, L, CE

■ CompoNet Master Unit

Unit type	Name	Specifications		Words required	Current consumption (A)		Model	Standards
		Communications types	Maximum number of I/O points per Master		5 V system	26 V system		
CS1 Special I/O Unit	CompoNet Master Unit 	<ul style="list-style-type: none"> Remote I/O communications Message communications 	Word Slave Units: 1,024 inputs and 1,024 outputs (2,048 I/O points total) Bit Slave Units: 256 inputs and 256 outputs (512 I/O points total)	1, 2, 4, or 8 unit numbers' words (variable)	0.4	---	CS1W-CRM21	U, U1, N, CE, L

■ CompoBus/S Master Unit

Unit type	Product name	Specifications		No. of unit numbers allocated	Current consumption (A)		Model	Standards
		Communications functions	Maximum number of I/O points per Master		5 V system	26 V system		
CS1 Special I/O Unit	CompoBus/S Master Unit 	Remote I/O communications	256 max. (128 inputs and 128 outputs)	2 unit numbers' words	0.15	---	CS1W-SRM21	U, C, CE
			128 max. (64 inputs and 64 outputs)	1 unit number's words				

■ ID Sensor Units

Unit type	Name	Specifications			Words required	Current consumption (A)		Model	Standards
		Connecting ID System	Number of RW Heads	External power supply		5 V system	26 V system		
CS1 Special I/O Unit	ID Sensor Unit	V680-series RFID system	1 head	Not required	1 unit number's words	0.26 (See note.)	0.13 (See note.)	CS1W-V680C11	UC, CE
			2 heads	24 V DC	2 unit numbers' words	0.32	---	CS1W-V680C12	
	ID Sensor Unit 	V600-series RFID system	1 head	Not required	1 unit number's words	0.26	0.12	CS1W-V600C11	UC, CE
			2 heads	24 V DC	2 unit numbers' words	0.32	---	CS1W-V600C12	

Note: The current consumption is 0.28 A when connected to the V680-H01. For details, refer to the *V680 Series RFID System Catalog* (Cat. No. Q151).

■ GP-IB Interface Unit

Unit type	Name	Specifications	Words required	Current consumption (A)		Model	Standards
				5 V system	26 V system		
CS1 Special I/O Unit	GP-IB Interface Unit 	Supports both Master mode and Slave mode.	1 unit number's words	0.33	---	CS1W-GPI01	UC, CE

Note: Up to 4 CS1W-GPI01 GP-IB Interface Units can be mounted (controlled by one CPU) in a CS1D CPU Backplane (CS1D-BC052 in a Duplex CPU System or CS1D-BC082S in a Single CPU System) or CS1D Expansion Backplane (CS1D-BI092). Up to 4 Units can be controlled by one CPU.

■ SPU Unit (High-speed Data Storage Units)

SPU Unit (High-speed Data Storage Units)

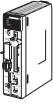
Unit type	Name	Specifications		Words required	Current consumption (A)		Model	Standards
		PC Card slot	Ethernet LAN port		5 V system	26 V system		
CS1 CPU Bus Unit	SPU Unit (High-speed Data Storage Unit) 	1 PC Card Type II slot Insert an OMRON HMC-EF□□□□ to use the Memory Card.	1 port (10/100BASE-TX)	1 unit number's words	0.56	---	CS1W-SPU01-V2	UC1, CE
			2 ports (10/100BASE-TX)		0.70		CS1W-SPU02-V2	

Programming Device

Name	Specifications	Model	Standards
SPU-Console Support Software	Functions: Setting the High-speed Data Storage Unit's unit settings, sampling settings, etc. (The software is required to make the High-speed Data Storage Unit's settings.) OS: Windows 7/Windows 8/Windows 8.1/Windows 10	WS02-SPTC1-V2	---

Options

Name	Specifications	Model	Standards	
SPU Data Management Middleware	Functions: Automatically uploads collected data files from the SPU Unit to the computer, and can also register the data in a database. OS: Windows XP/Windows Vista/Windows 7/Windows 8	1 license	WS02-EDMC1-V2	---
		5 licenses	WS02-EDMC1-V2L05	
Memory Cards 	Flash memory: 128 MB	Note: A memory Card is required to collect data.	HMC-EF183	---
	Flash memory: 256 MB (especially for the SPU Unit)		HMC-EF283	
	Flash memory: 512 MB (especially for the SPU Unit)		HMC-EF583	
	Memory Card Adapter (for a computer's PCMCIA slot)	HMC-AP001	CE	

MEMO

A large grid of dashed lines for writing a memo. The grid consists of 20 columns and 20 rows of squares, forming a coordinate system for notes.

MEMO

A large grid of dashed lines for writing a memo. The grid consists of 20 columns and 20 rows of squares, forming a coordinate system for notes.

Terms and Conditions Agreement

Read and understand this catalog.

Please read and understand this catalog before purchasing the products. Please consult your OMRON representative if you have any questions or comments.

Warranties.

(a) Exclusive Warranty. Omron's exclusive warranty is that the Products will be free from defects in materials and workmanship for a period of twelve months from the date of sale by Omron (or such other period expressed in writing by Omron). Omron disclaims all other warranties, express or implied.

(b) Limitations. OMRON MAKES NO WARRANTY OR REPRESENTATION, EXPRESS OR IMPLIED, ABOUT NON-INFRINGEMENT, MERCHANTABILITY OR FITNESS FOR A PARTICULAR PURPOSE OF THE PRODUCTS. BUYER ACKNOWLEDGES THAT IT ALONE HAS DETERMINED THAT THE PRODUCTS WILL SUITABLY MEET THE REQUIREMENTS OF THEIR INTENDED USE.

Omron further disclaims all warranties and responsibility of any type for claims or expenses based on infringement by the Products or otherwise of any intellectual property right. (c) Buyer Remedy. Omron's sole obligation hereunder shall be, at Omron's election, to (i) replace (in the form originally shipped with Buyer responsible for labor charges for removal or replacement thereof) the non-complying Product, (ii) repair the non-complying Product, or (iii) repay or credit Buyer an amount equal to the purchase price of the non-complying Product; provided that in no event shall Omron be responsible for warranty, repair, indemnity or any other claims or expenses regarding the Products unless Omron's analysis confirms that the Products were properly handled, stored, installed and maintained and not subject to contamination, abuse, misuse or inappropriate modification. Return of any Products by Buyer must be approved in writing by Omron before shipment. Omron Companies shall not be liable for the suitability or unsuitability or the results from the use of Products in combination with any electrical or electronic components, circuits, system assemblies or any other materials or substances or environments. Any advice, recommendations or information given orally or in writing, are not to be construed as an amendment or addition to the above warranty.

See <http://www.omron.com/global/> or contact your Omron representative for published information.

Limitation on Liability; Etc.

OMRON COMPANIES SHALL NOT BE LIABLE FOR SPECIAL, INDIRECT, INCIDENTAL, OR CONSEQUENTIAL DAMAGES, LOSS OF PROFITS OR PRODUCTION OR COMMERCIAL LOSS IN ANY WAY CONNECTED WITH THE PRODUCTS, WHETHER SUCH CLAIM IS BASED IN CONTRACT, WARRANTY, NEGLIGENCE OR STRICT LIABILITY.

Further, in no event shall liability of Omron Companies exceed the individual price of the Product on which liability is asserted.

Suitability of Use.

Omron Companies shall not be responsible for conformity with any standards, codes or regulations which apply to the combination of the Product in the Buyer's application or use of the Product. At Buyer's request, Omron will provide applicable third party certification documents identifying ratings and limitations of use which apply to the Product. This information by itself is not sufficient for a complete determination of the suitability of the Product in combination with the end product, machine, system, or other application or use. Buyer shall be solely responsible for determining appropriateness of the particular Product with respect to Buyer's application, product or system. Buyer shall take application responsibility in all cases.

NEVER USE THE PRODUCT FOR AN APPLICATION INVOLVING SERIOUS RISK TO LIFE OR PROPERTY OR IN LARGE QUANTITIES WITHOUT ENSURING THAT THE SYSTEM AS A WHOLE HAS BEEN DESIGNED TO ADDRESS THE RISKS, AND THAT THE OMRON PRODUCT(S) IS PROPERLY RATED AND INSTALLED FOR THE INTENDED USE WITHIN THE OVERALL EQUIPMENT OR SYSTEM.

Programmable Products.

Omron Companies shall not be responsible for the user's programming of a programmable Product, or any consequence thereof.

Performance Data.

Data presented in Omron Company websites, catalogs and other materials is provided as a guide for the user in determining suitability and does not constitute a warranty. It may represent the result of Omron's test conditions, and the user must correlate it to actual application requirements. Actual performance is subject to the Omron's Warranty and Limitations of Liability.

Change in Specifications.

Product specifications and accessories may be changed at any time based on improvements and other reasons. It is our practice to change part numbers when published ratings or features are changed, or when significant construction changes are made. However, some specifications of the Product may be changed without any notice. When in doubt, special part numbers may be assigned to fix or establish key specifications for your application. Please consult with your Omron's representative at any time to confirm actual specifications of purchased Product.

Errors and Omissions.

Information presented by Omron Companies has been checked and is believed to be accurate; however, no responsibility is assumed for clerical, typographical or proofreading errors or omissions.

Note: Do not use this document to operate the Unit.

OMRON Corporation Industrial Automation Company
Tokyo, JAPAN

Contact: www.ia.omron.com

Regional Headquarters

OMRON EUROPE B.V.

Wegalaan 67-69-2132 JD Hoofddorp
The Netherlands
Tel: (31)2356-81-300/Fax: (31)2356-81-388

OMRON ELECTRONICS LLC

One Commerce Drive Schaumburg,
IL 60173-5302 U.S.A.
Tel: (1) 847-843-7900/Fax: (1) 847-843-7787

OMRON ASIA PACIFIC PTE. LTD.

No. 438A Alexandra Road # 05-05/08 (Lobby 2),
Alexandra Technopark,
Singapore 119967
Tel: (65) 6835-3011/Fax: (65) 6835-2711

OMRON (CHINA) CO., LTD.

Room 2211, Bank of China Tower,
200 Yin Cheng Zhong Road,
PuDong New Area, Shanghai, 200120, China
Tel: (86) 21-5037-2222/Fax: (86) 21-5037-2200

Authorized Distributor:

© OMRON Corporation 2011-2012 All Rights Reserved.
In the interest of product improvement,
specifications are subject to change without notice.

CSM_9_7_0418
Cat. No. R103-E1-10

Printed in Japan
0712 (0802)