

Specification

AX42XX

SSC		Customer
Drawn	Approval	Approval

Contents

1. Description
2. Part number
3. Mechanical dimensions
4. Optical and thermal characteristics
5. Color spectrum, $T_a=25^{\circ}\text{C}$
6. Radiant pattern, $T_a=25^{\circ}\text{C}$
7. Relative Flux vs. Junction temperature
8. Color coordinate variation vs. Junction temperature
9. I-V characteristics, $T_a=25^{\circ}\text{C}$
10. Relative Flux vs. Forward voltage
11. Binning structure graphical representation
12. Operating instructions
13. Recommended solder pad
14. Emitter Reel Packaging
15. Solder profile
16. Precaution for use

AX42XX

Description

Acriche series is designed for AC source operation and high flux output applications.

Acriche is a semi-permanent and environmental semiconductor lighting that can be used in AC without additional device.

Acriche's thermal management perform exceeds other power LED solutions. It incorporates state of the art SMD design and Thermal emission material. Acriche is ideal light sources for general illumination Applications.



Features

- Connect directly in AC power
- Power Saving
- Long Life Time
- Simple BOM
- Miniaturization
- Low thermal resistance
- SMT solderability
- Lead Free product
- RoHS compliant

Applications

- Architectural lighting
- Residential lighting
- Task lighting
- Decorative / Pathway lighting





* The appearance and specifications of the product can be changed for improvement without notice.

Part number

1. Part Number form : A X₁ X₂ X₃ X₄ X₅ - X₆X₇ - X₈X₉X₁₀X₁₁

X₁	Color	N	Warm white
X₂	Acriche series	4	A4 series
X₃	Lens type	2	Dome type
X₄	Voltage	0	100V,RMS (PCB)
		1	110V,RMS (PCB)
		2	220V,RMS (PCB)
		3	230V,RMS (PCB)
		4	50,55V,RMS (Emitter)
X₅	PCB type	0	Emitter
		1	4W Compact
		2	4W Square
		3	4W Line
		4	8W Bulb
X₆	-	-	Internal code
X₇	-	-	Internal code
X₈	Brightness bin	-	-
X₉	Color bin	-	-
X₁₀	Color bin	-	-
X₁₁	VF bin	-	-

2. Sticker Diagram on Reel & Aluminum Vinyl Bag

PART NO. : A X₁ X₂ X₃ X₄ X₅ - X₆ X₇

 QUANTITY : ###

 LOT NUMBER : #####

 BIN CODE : X₈ X₉ X₁₀ X₁₁

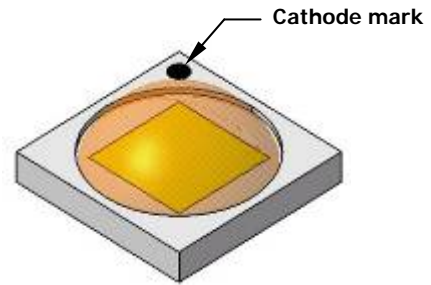
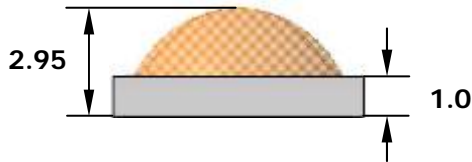
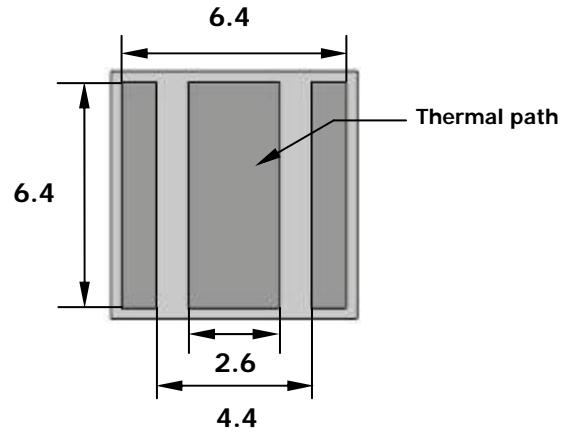
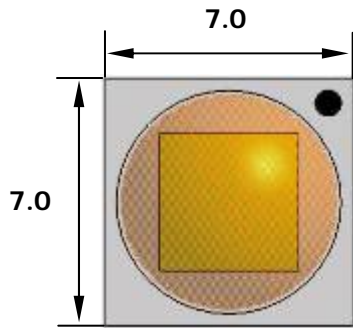

* For more information about binning and labeling, refer to the AX42XX Bin & Labeling
 * For more information about PCB type, refer to the AX42XX module specification

Mechanical dimensions

1. Outline dimensions



2. Recommended PCB solder pad

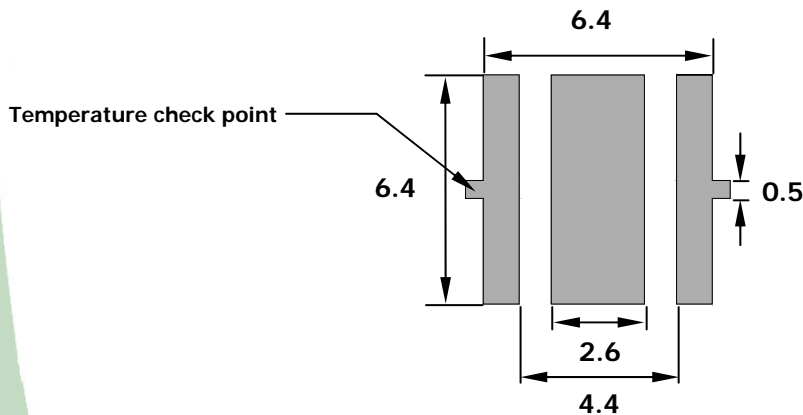

* Notes :

- [1] All dimensions are in millimeters. (Tolerance : ± 0.2)
- [2] Scale : none
- [3] The appearance and specifications of the product may be changed for improvement without notice
- [4] Electrically neutral thermal path

Optical and thermal characteristics

1. Warm white

1-1 Electro-Optical characteristics at 55V[RMS] Ta=25°C

Parameter	Symbol	Value			Unit
		Min	Typ	Max	
Luminous Flux ^[1]	Φ_V ^[2]	-	50	-	lm
Illuminance ^[3]	Φ_I	-	100	-	lx
Correlated Color Temperature ^[4]	CCT	-	3000	-	K
CRI	R _a	-	85	-	-
Operating Current	I _{opt}	-	20	-	mA [RMS]
Power Dissipation	P _D	0.76			W
Operating Frequency	Freq	50 / 60			Hz
Thermal resistance	R _{th}	10			°C/W
View Angle	2 Θ 1/2	134			deg.

1-2 Absolute Maximum Ratings

Parameter	Symbol	Value	Unit
Operating Voltage	V _{opt} ^[5]	63	V [RMS]
Power Dissipation	P _D	1.4	W
Junction Temperature	T _J	125	°C
Operating Temperature	T _{opr}	-30 ~ +85	°C
Storage Temperature	T _{stg}	-40 ~ +120	°C
ESD Sensitivity	-	±6,000V HBM	-

* Notes :

- [1] Acriche series maintains a tolerance of ±10% on flux and power measurements.
- [2] Φ_V is the total luminous flux output as measured with an integrated sphere.
- [3] Illuminance is measured at 50cm distance
- [4] Correlated Color Temperature is derived from the CIE 1931 Chromaticity diagram.
CCT ±5% tester tolerance
- [5] 'Operating Voltage' doesn't indicate the maximum voltage which customers use, but it means tolerable voltage according to the voltage variation rate by one's country.
It is recommended that the temperature of solder pad should be below 70°C.

Color spectrum, Ta=25°C

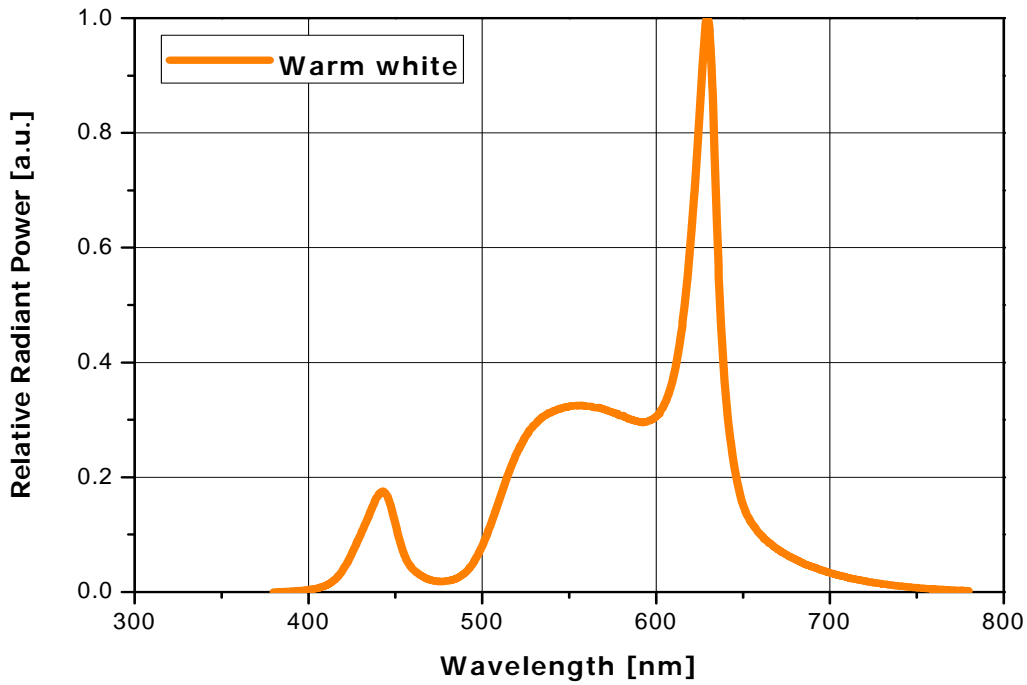

Radiation pattern, Ta=25°C

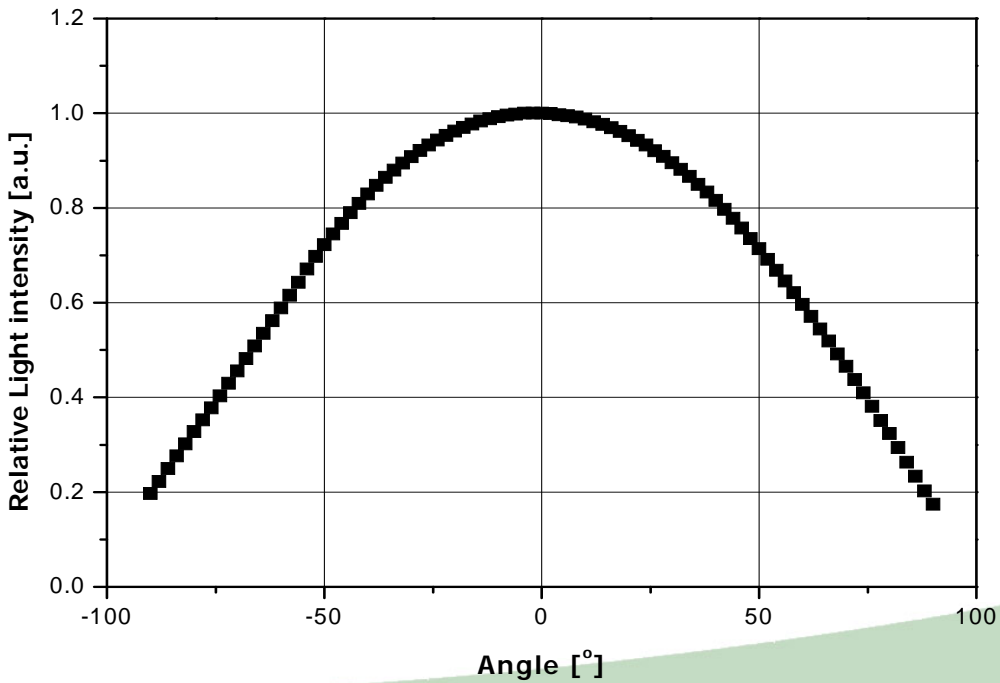

IV characteristics, Ta=25°C

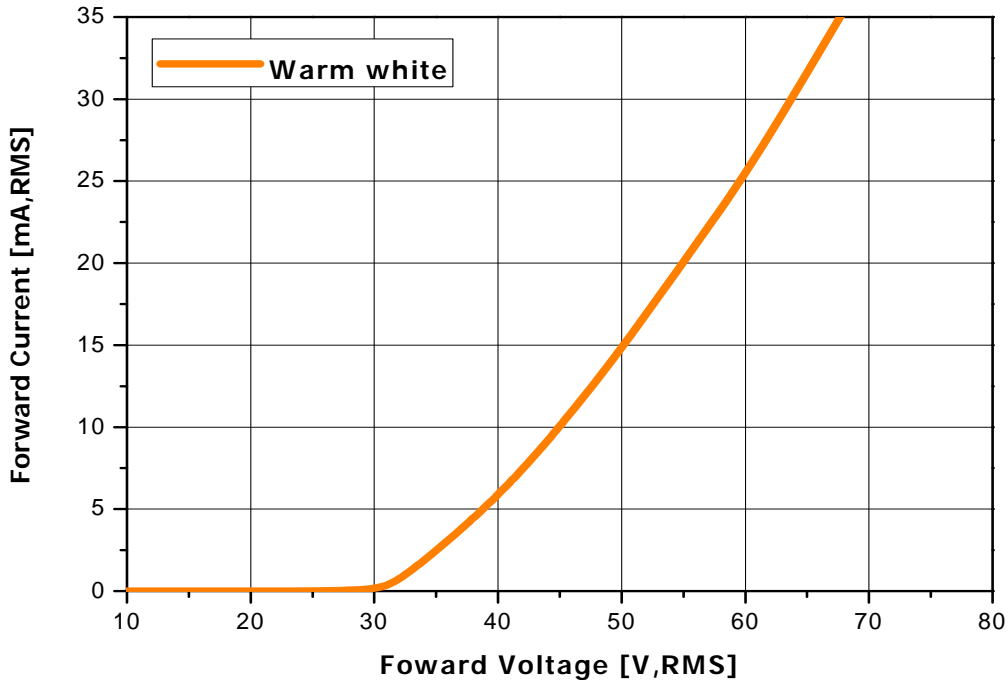

Relative Flux vs. Forward voltage

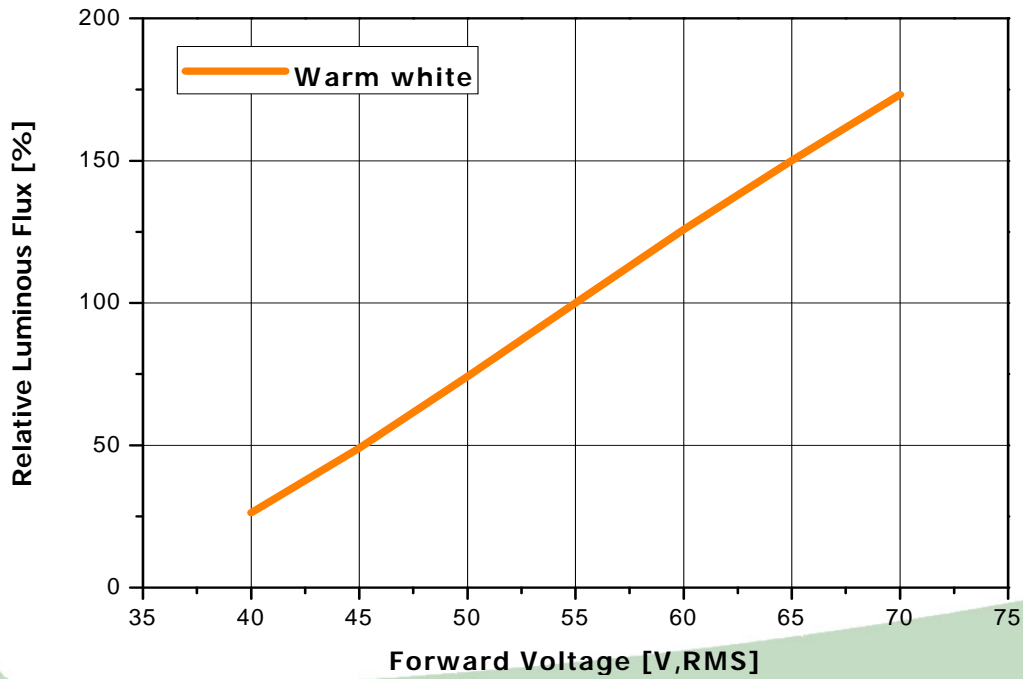

Relative Flux vs. Junction temperature (20mA,RMS@55V,RMS)

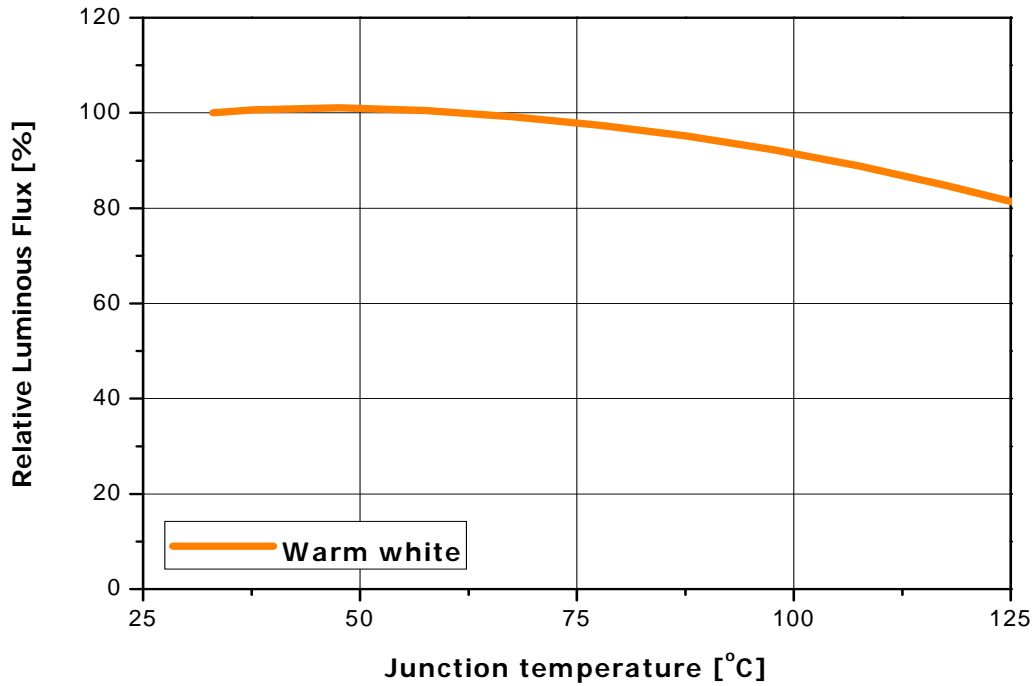

CCT variation vs. Junction temperature (20mA,RMS@55V,RMS)

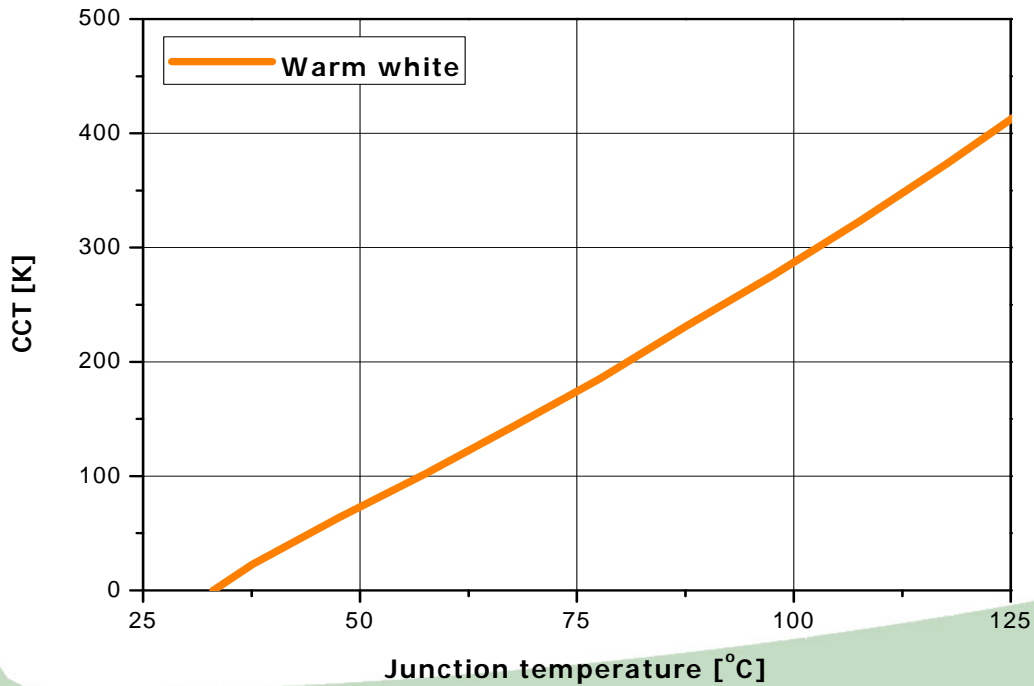

Color coordinate vs. Junction temperature (20mA,RMS@55V,RMS)

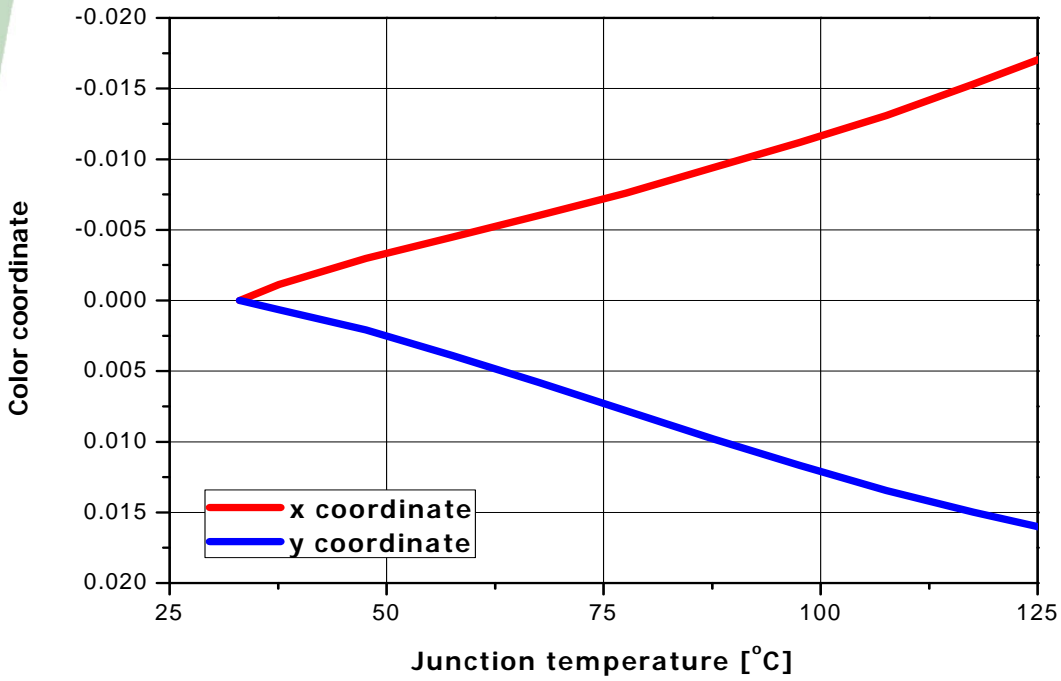

Binning structure graphical representation

Energy Star Rank

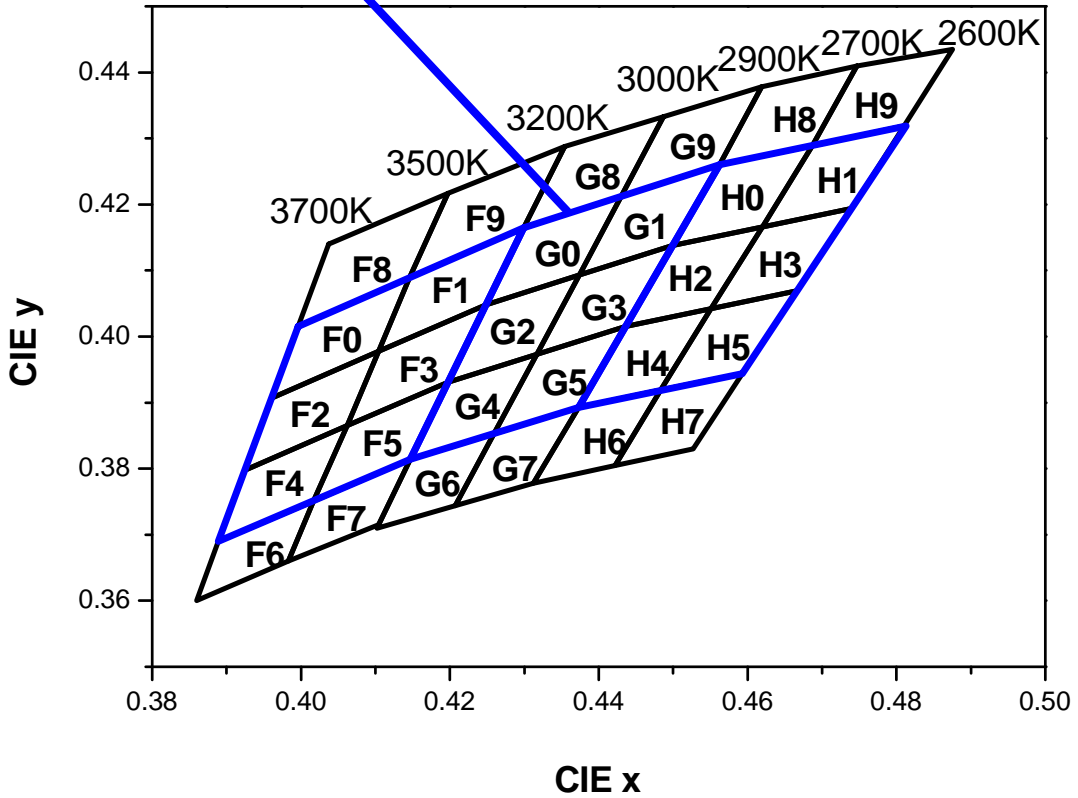

* For more information about binning and labeling, refer to the Application Note -1

Operating instructions

1. Basic connections of AX42XX for AC source

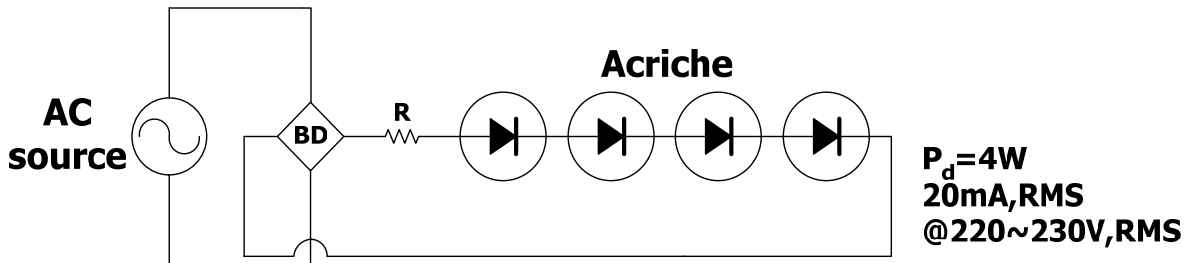
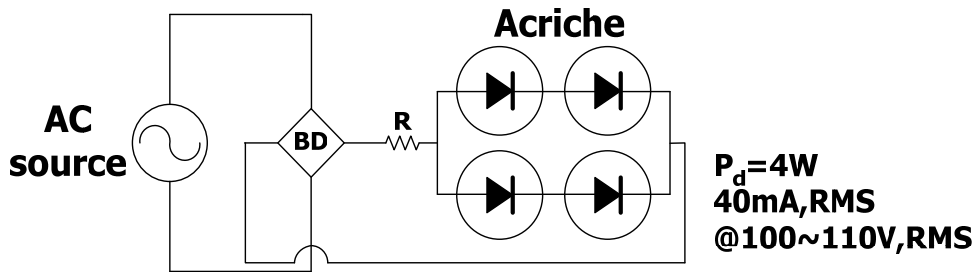
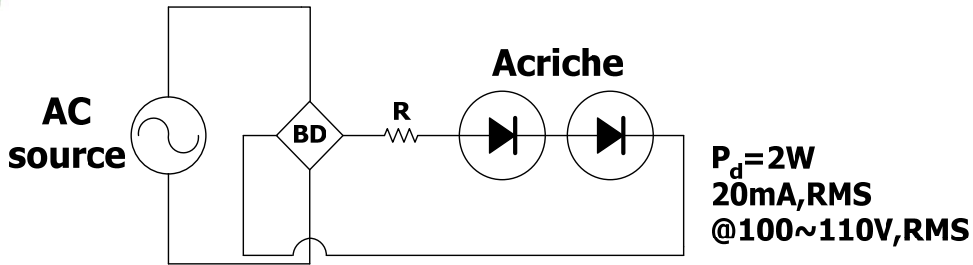

* Notes :

- [1] A4 series need bridge diode and external resistor.
- [2] The tolerance of current is $\pm 5\%$ on each resistance rank.
- [3] For more information about Acrich connection, refer to the Application Note.

Solder profile

1. Reflow solder conditions / profile

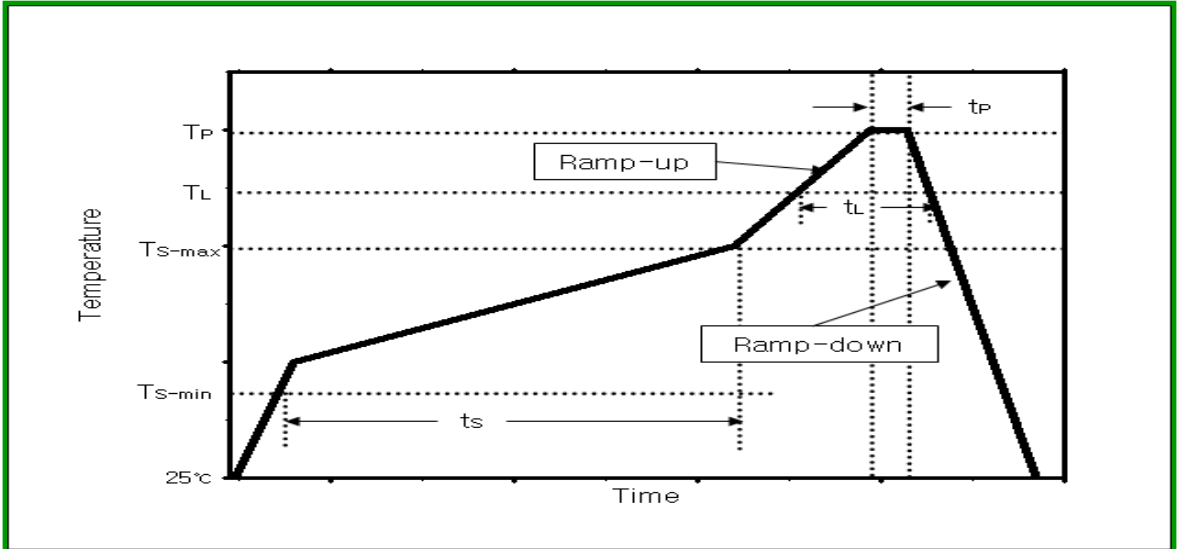

Reflow condition	Pb-Free assembly
Average ramp-up rate (Ts-max to Peak)	2~3°C / second
Preheat Temperature Min (Ts-min)	150°C
Preheat Temperature Max (Ts-max)	200°C
Time maintained above: : Liquidus Temperature (TL)	217~220°C
Time maintained above: Time (tL)	60~150 seconds
Peak Temperature (TP)	250°C
Time within 5°C of actual Peak Temperature (tp)	20~40 seconds
ramp-down rate	4~6°C / second
Time 25°C to Peak Temperature	6 minutes max

2. Hand Solder conditions

- 2-1 Lead : Not more than 3 seconds @MAX280°C
- 2-2 Slug : Use a thermal-adhesives

* Caution

- [1] Reflow soldering should not be done more than one time.
- [2] Repairing should not be done after the LEDs have been soldered. When repairing is unavoidable, suitable tools have to be used.
- [3] Die slug is to be soldered.
- [4] When soldering, do not put stress on the LEDs during heating.
- [5] After soldering, do not warp the circuit board.
- [6] Recommend to use a convection type reflow machine with 7 ~ 8 zones.

Rev. 03

September 2010

www.acriche.com

서식번호 : SSC-QP-7-07-25 (Rev.00)