

# MAX44291/MAX44292/ MAX44294

# 36V, Single/Dual/Quad, Low-Noise Amplifiers with Maximum $0.5\mu\text{V}/^\circ\text{C}$ Offset Drift

## General Description

The MAX44291/MAX44292/MAX44294 are single/dual/quad low-noise, precision operational amplifiers. The low offset and low noise specifications and high supply range make the MAX44291/MAX44292/MAX44294 ideal for sensor interfaces, loop-powered systems, and various types of medical and data acquisition instruments.

The MAX44291/MAX44292/MAX44294 operate with a wide supply voltage range from a 4.5V to 36V single supply or dual  $\pm 2.25\text{V}$  to  $\pm 18\text{V}$  supplies, and consume only 1.2mA/channel (typ). The MAX44291 features a shutdown input that reduces the supply current to  $1\mu\text{A}$ /channel (typ) when in shutdown mode.

The rail-to-rail output swing maximizes the dynamic range when driving high-resolution ADCs even with low supply voltage. These devices achieve 10MHz of gain-bandwidth product.

The MAX44291/MAX44292/MAX44294 are available in 8-pin  $\mu\text{MAX}$ ® (single), 8-pin SO (dual), and 14-pin SO (quad) packages and are specified over the  $-40^\circ\text{C}$  to  $+125^\circ\text{C}$  automotive temperature range.

*$\mu\text{MAX}$  is a registered trademark of Maxim Integrated Products, Inc.*

**Ordering Information** appears at end of data sheet.

## Typical Application Circuit

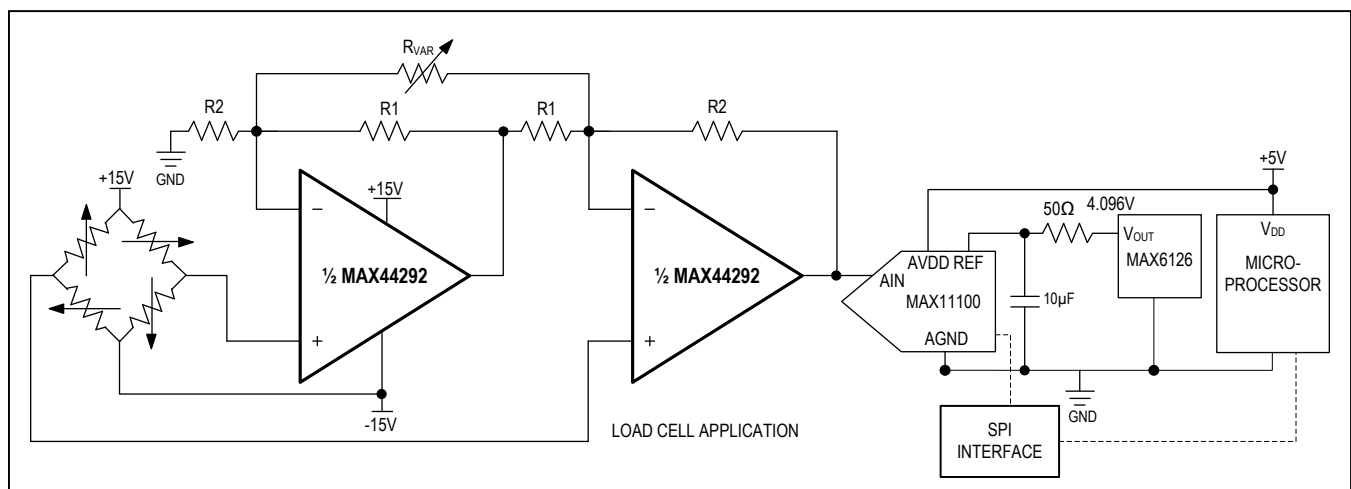

## Benefits and Features

- Low Input Noise and High Bandwidth to Drive Precision ADCs
  - $4.9\text{nV}/\sqrt{\text{Hz}}$  Low Input Noise
  - 10MHz Gain-Bandwidth Product
- Low Input Offset Ensures Accurate Results Over Temperature
  - $125\mu\text{V}$  (max) Low Input Offset Voltage
  - $0.5\mu\text{V}/^\circ\text{C}$  (max) Offset Drift
- Low 1.2mA Quiescent Current (Per Channel) Does Not Break the Power Budget
- ESD Protection Provides Robust Front-End
  - $\pm 8\text{kV}$  Human Body Model
  - $\pm 1\text{kV}$  Charged Device Model
- Wide Supply for High-Voltage Front-Ends
  - Single 4.5V to 36V or Dual  $\pm 2.25\text{V}$  to  $\pm 18\text{V}$  Supply Ranges
- 8-Pin  $\mu\text{MAX}$  and 8-/14-Pin SO Packages Save Board Space

## Applications

- Portable Logic Controllers
- Instrumentation
- Test and Measurement Systems
- Sensor Interfaces

### Absolute Maximum Ratings

V <sub>DD</sub> to V <sub>SS</sub> .....	-0.3V to +40V	8-Pin SO (derate 7.40mW/°C above + 70°C).....	588.20mW
Common-Mode Input Voltage.....	(V <sub>SS</sub> - 0.3V) to (V <sub>DD</sub> + 0.3V)	14-Pin SO (derate 12.2mW/°C above + 70°C).....	975.60mW
SHDN .....	(V <sub>SS</sub> - 0.3V) to (V <sub>DD</sub> + 0.3V)	Operating Temperature Range.....	-40°C to +125°C
Differential Input Voltage (IN <sub>+</sub> - IN <sub>-</sub> ).....	10V	Junction Temperature.....	+150°C
OUT <sub>-</sub> to V <sub>SS</sub> .....	-0.3V to (V <sub>DD</sub> + 0.3V)	Storage Temperature Range.....	-65°C to +150°C
Continuous Input Current (any pin).....	±20mA	Lead Temperature (soldering, 10s).....	+300°C
Output Short-Circuit Duration (OUT <sub>-</sub> ).....	1s	Soldering Temperature (reflow).....	+260°C
Continuous Power Dissipation (T <sub>A</sub> = +70°C)			
µMAX (derate 4.8mW/°C above + 70°C).....	387.8mW		

Stresses beyond those listed under "Absolute Maximum Ratings" may cause permanent damage to the device. These are stress ratings only, and functional operation of the device at these or any other conditions beyond those indicated in the operational sections of the specifications is not implied. Exposure to absolute maximum rating conditions for extended periods may affect device reliability.

### Package Thermal Characteristics (Note 1)

µMAX		14-SO	
Junction-to-Ambient Thermal Resistance (θ <sub>JA</sub> ).....	206.3°C/W	Junction-to-Ambient Thermal Resistance (θ <sub>JA</sub> ).....	.82°C/W
Junction-to-Case Thermal Resistance (θ <sub>JC</sub> ).....	42°C/W	Junction-to-Case Thermal Resistance (θ <sub>JC</sub> ).....	32°C/W
8-SO			
Junction-to-Ambient Thermal Resistance (θ <sub>JA</sub> ).....	136°C/W		
Junction-to-Case Thermal Resistance (θ <sub>JC</sub> ).....	38°C/W		

**Note 1:** Package thermal resistances were obtained using the method described in JEDEC specification JESD51-7, using a four-layer board. For detailed information on package thermal considerations, refer to [www.maximintegrated.com/thermal-tutorial](http://www.maximintegrated.com/thermal-tutorial).

### Electrical Characteristics

(V<sub>DD</sub> = +15V, V<sub>SS</sub> = -15V, R<sub>L</sub> = 10kΩ to V<sub>GND</sub> = 0V, V<sub>IN+</sub> = V<sub>IN-</sub> = V<sub>GND</sub> = 0V, V<sub>SHDN</sub> = 0V (MAX44291 only), T<sub>A</sub> = -40°C to +125°C. Typical values are at T<sub>A</sub> = +25°C, unless otherwise noted.) (Note 2)

PARAMETER	SYMBOL	CONDITIONS	MIN	TYP	MAX	UNITS
<b>POWER SUPPLY</b>						
Supply Voltage Range	V <sub>DD</sub>	Guaranteed by PSRR	4.5		36	V
Supply Current	I <sub>DD</sub>	R <sub>L</sub> = ∞	T <sub>A</sub> = +25°C			mA
			-40°C ≤ T <sub>A</sub> ≤ +125°C		2.1	
Power-Supply Rejection Ratio	PSRR	T <sub>A</sub> = +25°C		125	140	dB
		-40°C ≤ T <sub>A</sub> ≤ +125°C		120		
<b>SHUTDOWN (MAX44291 Only)</b>						
Shutdown Input Voltage	V <sub>SHDN</sub>	Device disabled	V <sub>DD</sub> - 0.35		V <sub>DD</sub>	V
		Device enabled	V <sub>SS</sub>		V <sub>DD</sub> - 3.0	
Shutdown Current	I <sub>SHDN</sub>	V <sub>SHDN</sub> = V <sub>DD</sub>		1		µA
<b>DC SPECIFICATIONS</b>						
Input Common-Mode Range	V <sub>CM</sub>	Guaranteed by CMRR test	V <sub>SS</sub> + 1.8		V <sub>DD</sub> - 1.4	V
Common-Mode Rejection Ratio	CMRR	V <sub>SS</sub> + 1.8V ≤ V <sub>CM</sub> ≤ V <sub>DD</sub> - 1.4V, T <sub>A</sub> = +25°C	120	135		dB
		V <sub>SS</sub> + 2V ≤ V <sub>CM</sub> ≤ V <sub>DD</sub> - 1.6V, -40°C ≤ T <sub>A</sub> ≤ +125°C	110			

**Electrical Characteristics (continued)**

( $V_{DD} = +15V$ ,  $V_{SS} = -15V$ ,  $R_L = 10k\Omega$  to  $V_{GND} = 0V$ ,  $V_{IN+} = V_{IN-} = V_{GND} = 0V$ ,  $V_{SHDN} = 0V$  (MAX44291 only),  $T_A = -40^{\circ}C$  to  $+125^{\circ}C$ . Typical values are at  $T_A = +25^{\circ}C$ , unless otherwise noted.) (Note 2)

PARAMETER	SYMBOL	CONDITIONS	MIN	TYP	MAX	UNITS
Input Offset Voltage	$V_{OS}$	$T_A = +25^{\circ}C$		30	125	$\mu V$
		$-40^{\circ}C \leq T_A \leq +125^{\circ}C$			165	
Input Offset Voltage Drift	$TCV_{OS}$	(Note 3)		0.2	0.5	$\mu V/^{\circ}C$
Input Bias Current	$I_B$	$T_A = +25^{\circ}C$		6	25	nA
		$-40^{\circ}C \leq T_A \leq +125^{\circ}C$			55	
Input Offset Current	$I_{OS}$	$T_A = +25^{\circ}C$		4	12	nA
		$-40^{\circ}C \leq T_A \leq +125^{\circ}C$			30	
Open-Loop Gain	$A_{VOL}$	$V_{SS} + 0.2V \leq V_{OUT} \leq V_{DD} - 0.2V$ , $R_L = 10k\Omega$	$T_A = +25^{\circ}C$	130	140	dB
			$-40^{\circ}C \leq T_A \leq +125^{\circ}C$	125		
Output Voltage Swing	$V_{OH}$	$V_{DD} - V_{OUT}$	$T_A = +25^{\circ}C$	100	160	mV
			$-40^{\circ}C \leq T_A \leq +125^{\circ}C$		220	
	$V_{OL}$	$V_{OUT} - V_{SS}$	$T_A = +25^{\circ}C$	100	160	
			$-40^{\circ}C \leq T_A \leq +125^{\circ}C$		220	
Output Short-Circuit Current	$I_{SC}$	To $V_{DD}$ or $V_{SS}$ (1s max)		60		mA
<b>AC SPECIFICATIONS</b>						
Input Voltage-Noise Density	$e_N$	$f = 1kHz$		4.9		$nV/\sqrt{Hz}$
Input Voltage Noise		$0.1Hz \leq f \leq 10Hz$		288		$nV_{P-P}$
Input Current-Noise Density	$i_N$	$f = 1kHz$		0.89		$pA/\sqrt{Hz}$
Gain-Bandwidth Product	GBW	$V_{IN} = 100mV_{P-P}$		10		MHz
Slew Rate	SR	$A_V = 1V/V$ , $V_{OUT} = 2V_{P-P}$		5		$V/\mu s$
Settling Time	$t_S$	To 0.01%, $V_{OUT} = 10V_{P-P}$ , $C_L = 100pF$ , $A_V = 1V/V$		2		$\mu s$
Total Harmonic Distortion Plus Noise	THD+N	$f = 1kHz$ , $V_{OUT} = 2V_{P-P}$ , $A_V = 1V/V$		-110		dB
Capacitive Loading	$C_L$	No sustained oscillation, $A_V = 1V/V$		100		pF

**Note 2:** All devices are 100% production tested at  $T_A = +25^{\circ}C$ . Temperature limits are guaranteed by design.

**Note 3:** Guaranteed by design.

### Typical Operating Characteristics

( $V_{DD} = +15V$ ,  $V_{SS} = -15V$ ,  $R_L = 10k\Omega$  connected to GND.  $V_{IN+} = V_{IN-} = V_{GND} = 0V$ ,  $V_{SHDN} = 0V$ ,  $T_A = +25^{\circ}C$ , unless otherwise specified.)

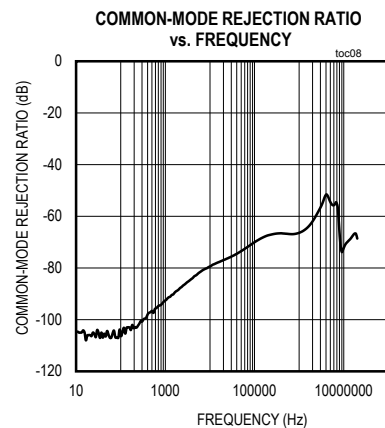
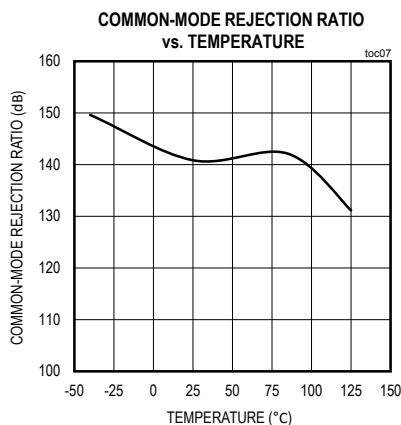
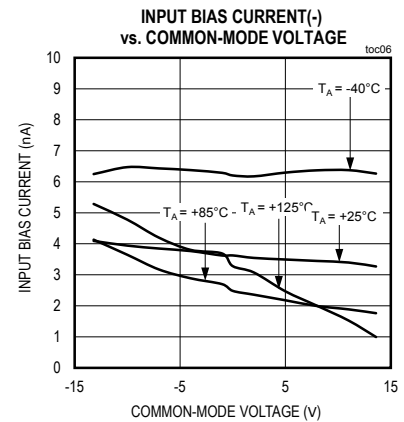
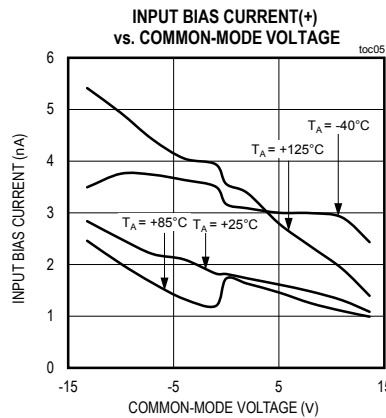
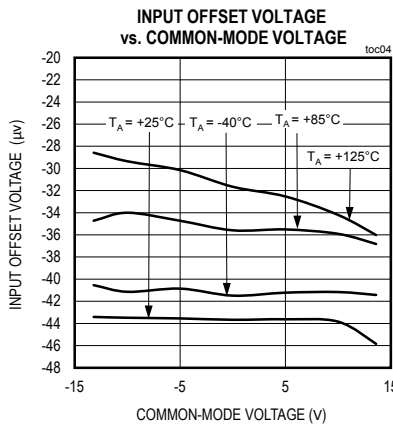
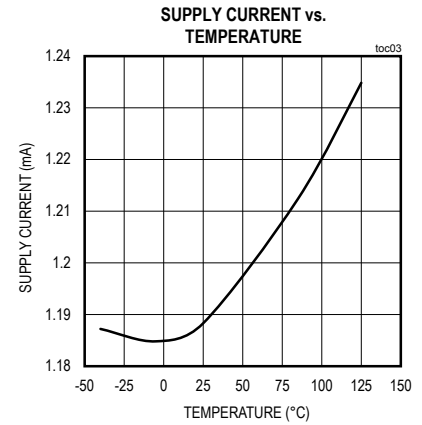
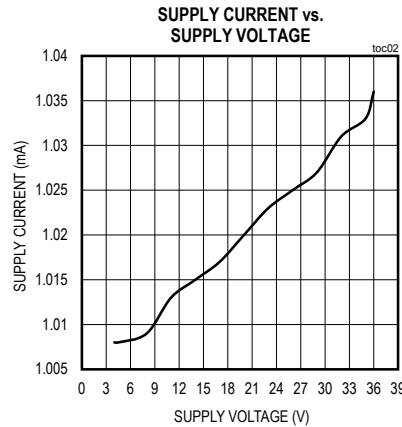
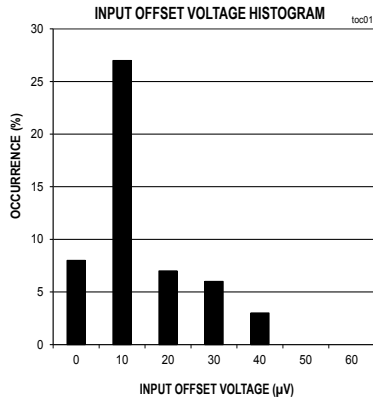

Typical Operating Characteristics (continued)

( $V_{DD} = +15V$ ,  $V_{SS} = -15V$ ,  $R_L = 10k\Omega$  connected to GND.  $V_{IN+} = V_{IN-} = V_{GND} = 0V$ ,  $V_{SHDN} = 0V$ ,  $T_A = +25^{\circ}C$ , unless otherwise specified.)

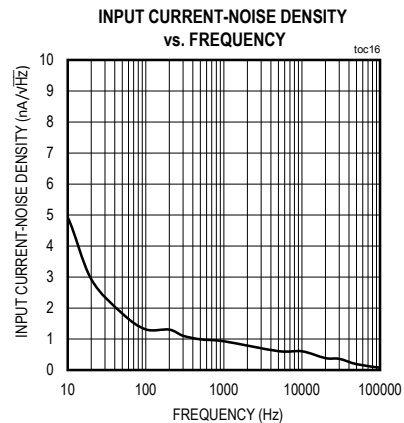
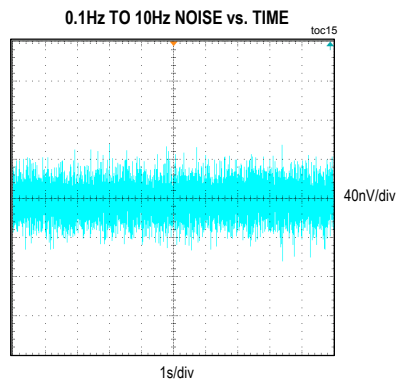
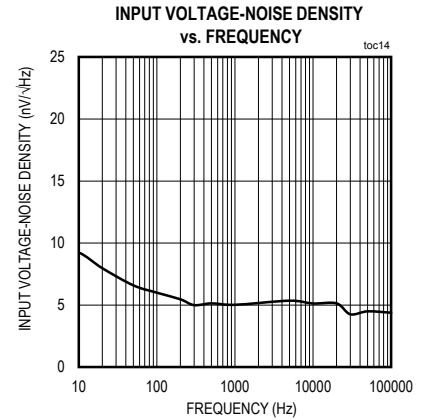
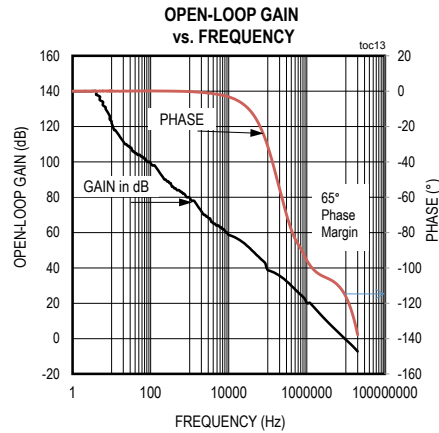
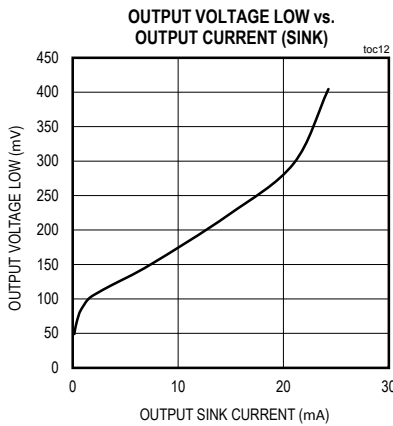
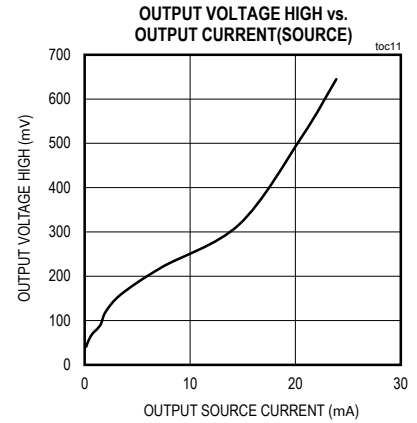
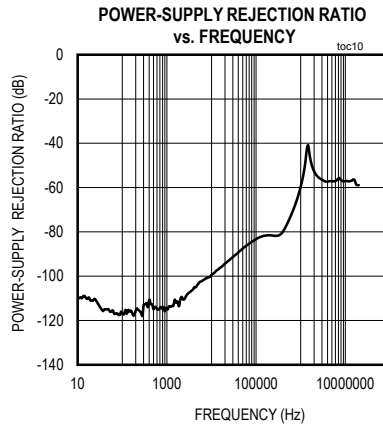
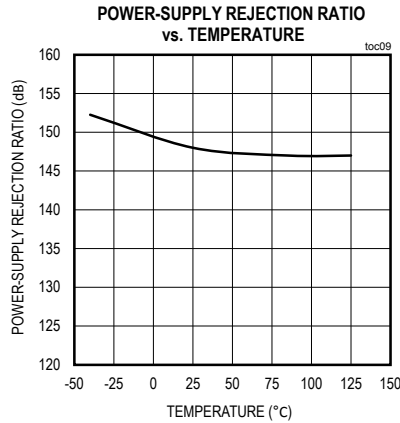

Typical Operating Characteristics (continued)

( $V_{DD} = +15V$ ,  $V_{SS} = -15V$ ,  $R_L = 10k\Omega$  connected to GND.  $V_{IN+} = V_{IN-} = V_{GND} = 0V$ ,  $V_{SHDN} = 0V$ ,  $T_A = +25^{\circ}C$ , unless otherwise specified.)

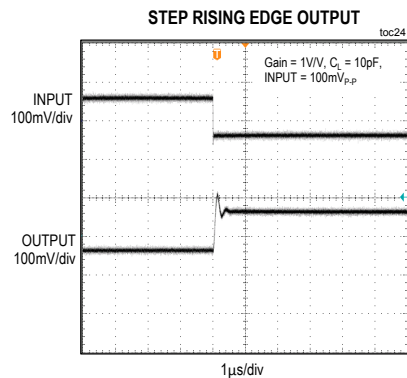
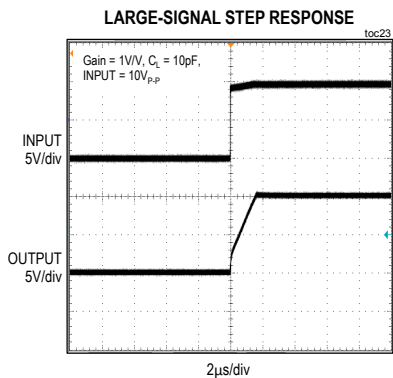
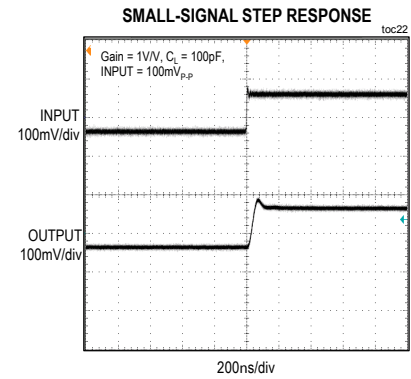
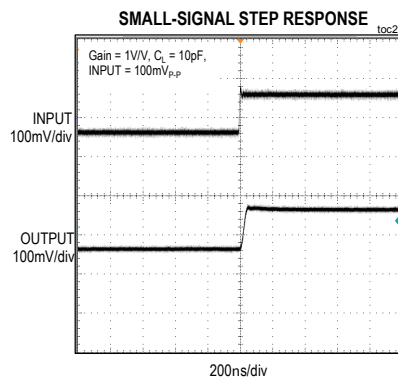
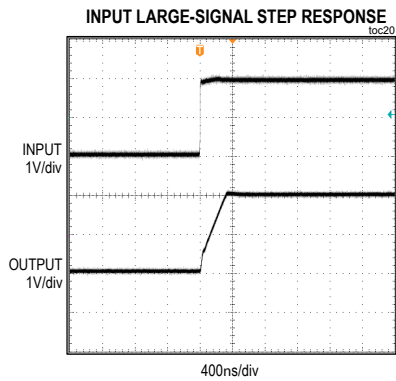
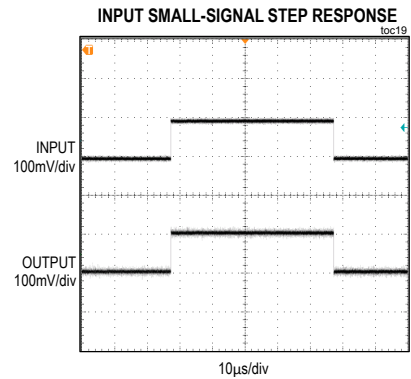
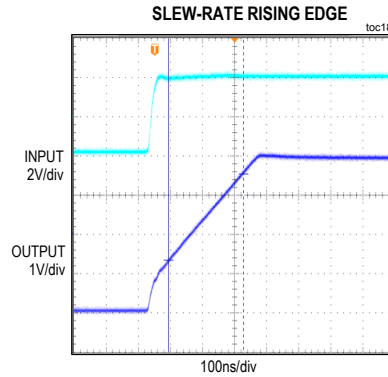
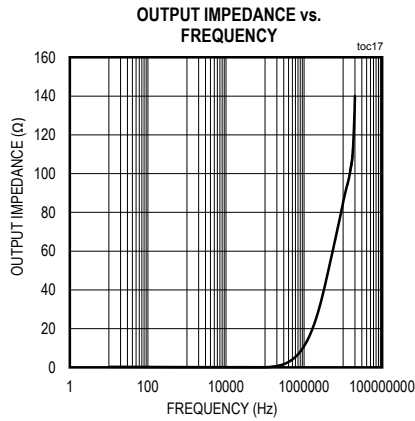

Typical Operating Characteristics (continued)

(V<sub>DD</sub> = +15V, V<sub>SS</sub> = -15V, R<sub>L</sub> = 10kΩ connected to GND. V<sub>IN+</sub> = V<sub>IN-</sub> = V<sub>GND</sub> = 0V, V<sub>SHDN</sub> = 0V, T<sub>A</sub> = +25°C, unless otherwise specified.)

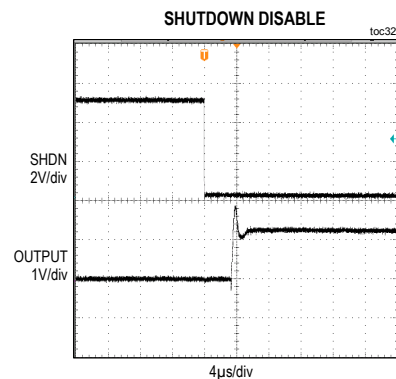
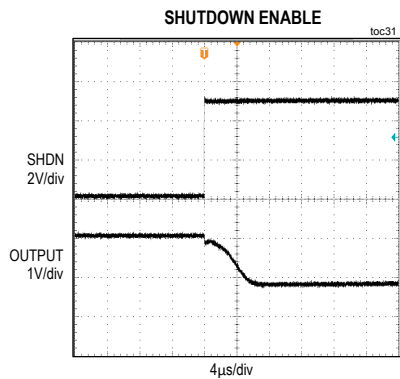
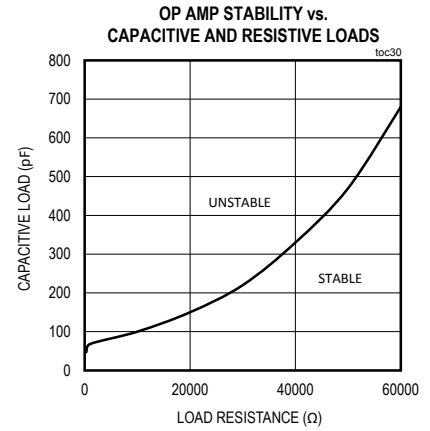
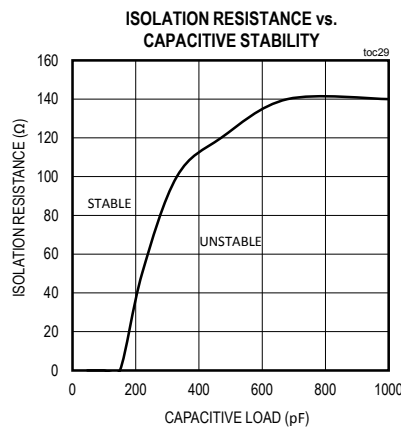
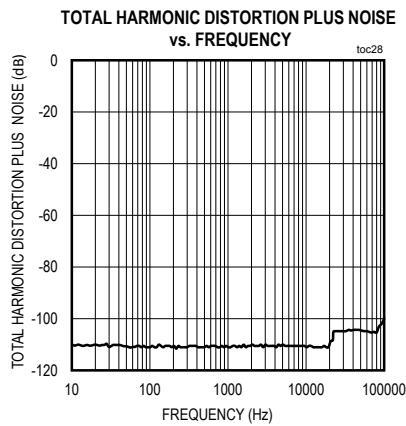
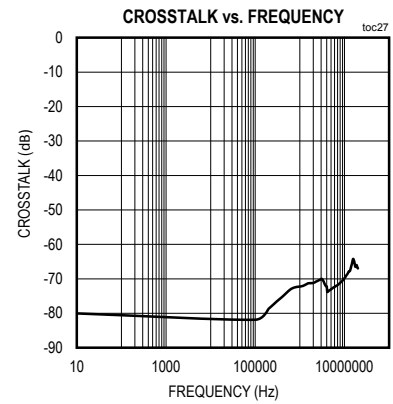
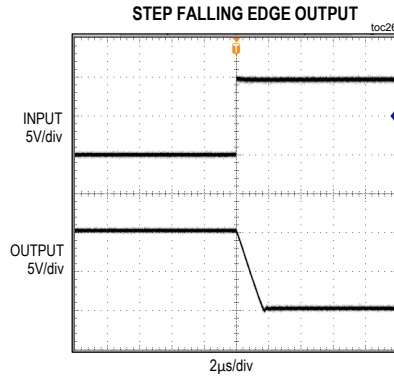
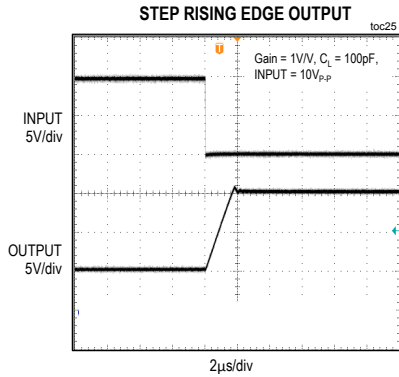

## Pin Configurations

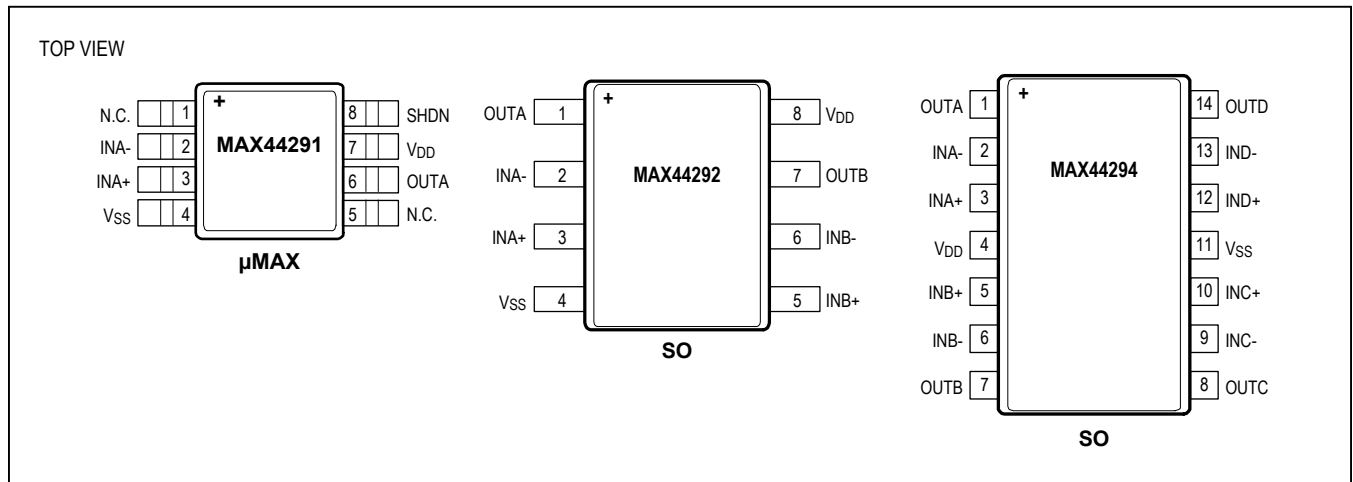

## Pin Description

PIN			NAME	FUNCTION
MAX44291	MAX44292	MAX44294		
μMAX	8 SO	14 SO		
1, 5	—	—	N.C.	No Connection. Not internally connected.
2	2	2	INA-	Channel A Negative Input
3	3	3	INA+	Channel A Positive Input
4	4	11	VSS	Negative Supply Voltage
6	1	1	OUTA	Channel A Output
7	8	4	VDD	Positive Supply Voltage
8	—	—	SHDN	Active-High Shutdown Input
—	5	5	INB+	Channel B Positive Input
—	6	6	INB-	Channel B Negative Input
—	7	7	OUTB	Channel B Output
—	—	8	OUTC	Channel C Output
—	—	9	INC-	Channel C Negative Input
—	—	10	INC+	Channel C Positive Input
—	—	12	IND+	Channel D Positive Input
—	—	13	IND-	Channel D Negative Input
—	—	14	OUTD	Channel D Output



## Detailed Description

The MAX44291/MAX44292/MAX44294 are precision, low-noise, 10MHz bandwidth amplifiers with exceptional distortion performance. They are designed in a new 36V, high-speed complementary BiCMOS process that is optimized for excellent AC dynamic performance combined with high-voltage operation.

The MAX44291/MAX44292/MAX44294 are unity-gain stable and operate either with single-supply voltage from 4.5V to 36V or with dual supplies from  $\pm 2.25$ V to  $\pm 18$ V.

## Applications Information

### High Operating Supply Voltage Range

The MAX44291/MAX44292/MAX44294 operate with a wide voltage range from single supply +4.5V to +36V or dual supplies from  $\pm 2.25$ V to  $\pm 18$ V. These devices consume only 1.2mA (typical) of supply current per channel. Although the MAX44291/MAX44292/MAX44294 support high-voltage operation with excellent performance, the devices also operate in many battery-operated or portable equipment applications at 5V.

### Input Protection

The MAX44291/MAX44292/MAX44294 have a typical ESD protection scheme with diodes from input, output, and shutdown pins to either rails. Also, as shown in [Figure 1](#), the protection scheme shows diodes and a resistor string between the inputs to protect the IC from large differential inputs. Input series resistors act as current-limiting resistors when a large differential voltage is accidentally applied.

### Rail-to-Rail Output Stage

The MAX44291/MAX44292/MAX44294 output stage swings to within 100mV (typ) of either power-supply rail with a 10k $\Omega$  load to ground and provides a 10MHz GBW with a 5V/ $\mu$ s slew rate. The devices are unity-gain stable, and can drive a 100pF capacitive load without compromising stability. Stability with higher capacitive loads can be improved by adding an isolation resistor in series with the op-amp output. This resistor improves the circuit's phase margin by isolating the load capacitor from the amplifier's output. The graph in the *Typical Operating Characteristics* shows a profile of the isolation resistor and capacitive load values that maintain the devices in the stable region.

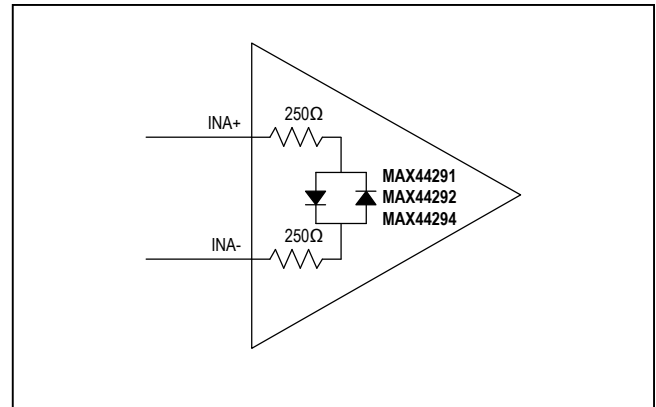

Figure 1. Showing Input Differential Protection Scheme

### Shutdown (MAX44291 Only)

The MAX44291 shutdown input is referenced to the positive supply. See the *Electrical Characteristics* table for the proper levels of functionality. A high level (above  $V_{DD} - 0.35$ V) disables the op amp and puts the output into high-impedance state. A low level (below  $V_{DD} - 3$ V) enables the device. As an example, if the op amp is powered with dual supplies of  $\pm 15$ V, the device is enabled when the shutdown voltage is at or below 12V. The device is disabled when the shutdown voltage is at or above 14.65V. If the op amp is powered with 36V single supply, the device is enabled when the shutdown voltage is at or below 33V. The device is disabled when the shutdown voltage is at or above 35.65V. This input must be connected to either a valid high or low voltage. Do not leave it unconnected.

When in shutdown mode, the amplifier consumes only 1.8 $\mu$ A (typical) of supply current.

### Power Supplies and Layout

The MAX44291/MAX44292/MAX44294 operate with dual supplies from  $\pm 2.25$ V to  $\pm 18$ V or with a single supply from +4.5V to +36V with respect to ground. When used with dual supplies, bypass both  $V_{DD}$  and  $V_{SS}$  with 0.1 $\mu$ F capacitor to ground closer to  $V_{DD}$  and 10 $\mu$ F capacitor to ground closer to where the power supply connection is made. When used with a single supply, bypass  $V_{DD}$  with a 0.1 $\mu$ F and 10 $\mu$ F capacitors to ground as explained above. Careful layout technique helps optimize performance by decreasing the amount of stray capacitance at the amplifier inputs and outputs. To decrease stray capacitance, minimize trace lengths by placing external components close to the amplifier pins.

### Electrostatic Discharge (ESD)

The MAX44291/MAX44292/MAX44294 have built-in circuits to protect from electrostatic discharge (ESD) events. An ESD event produces a short, high-voltage pulse that is transformed into a short current pulse once it discharges through the device. The built-in protection circuit provides a current path around the op amp that prevents it from being damaged. The energy absorbed by the protection circuit is dissipated as heat.

The MAX44291/MAX44292/MAX44294 guarantee ESD protection up to 8kV with Human Body Model (HBM). The Human Body Model simulates the ESD phenomenon wherein a charged body directly transfers its accumulated electrostatic charge to the ESD-sensitive device. A common example of this phenomenon is when a person accumulates static charge by walking across a carpet and

then transferring all of the charge to an ESD-sensitive device by touching it.

Not all ESD events involve the transfer of charge into the device. Electrostatic discharge from a charged device to another conductive body at lower potential is also a form of ESD. Such an ESD event is known as Charged Device Model (CDM) ESD, which can be even more destructive than HBM ESD (despite its shorter pulse duration) because of its high current. The MAX44291/MAX44292/MAX44294 guarantee CDM ESD protection up to 1kV.

MAX44291/MAX44292/  
MAX44294

36V, Single/Dual/Quad, Low-Noise Amplifiers with  
Maximum 0.5 $\mu$ V/ $^{\circ}$ C Offset Drift

## Ordering Information

PART	TEMP RANGE	PIN-PACKAGE
MAX44291AUA+	-40 $^{\circ}$ C to +125 $^{\circ}$ C	8 $\mu$ MAX
MAX44292ASA+	-40 $^{\circ}$ C to +125 $^{\circ}$ C	8 SO
MAX44294ASD+	-40 $^{\circ}$ C to +125 $^{\circ}$ C	14 SO

+Denotes lead(Pb)-free/RoHS-compliant package.

## Chip Information

PROCESS: BiCMOS

## Package Information

For the latest package outline information and land patterns (footprints), go to [www.maximintegrated.com/packages](http://www.maximintegrated.com/packages). Note that a "+", "#", or "-" in the package code indicates RoHS status only. Package drawings may show a different suffix character, but the drawing pertains to the package regardless of RoHS status.

PACKAGE TYPE	PACKAGE CODE	OUTLINE NO.	LAND PATTERN NO.
8 $\mu$ MAX	U8+1	<a href="#">21-0036</a>	<a href="#">90-0092</a>
8 SO	S8+2	<a href="#">21-0041</a>	<a href="#">90-0096</a>
14 SO	S14M+4	<a href="#">21-0041</a>	<a href="#">90-0112</a>

MAX44291/MAX44292/  
MAX44294

36V, Single/Dual/Quad, Low-Noise Amplifiers with  
Maximum 0.5 $\mu$ V/ $^{\circ}$ C Offset Drift

## Revision History

REVISION NUMBER	REVISION DATE	DESCRIPTION	PAGES CHANGED
0	10/14	Initial release	—
1	5/15	Added the MAX44292 and MAX44294 to data sheet.	1–12

For pricing, delivery, and ordering information, please contact Maxim Direct at 1-888-629-4642, or visit Maxim Integrated's website at [www.maximintegrated.com](http://www.maximintegrated.com).

*Maxim Integrated cannot assume responsibility for use of any circuitry other than circuitry entirely embodied in a Maxim Integrated product. No circuit patent licenses are implied. Maxim Integrated reserves the right to change the circuitry and specifications without notice at any time. The parametric values (min and max limits) shown in the Electrical Characteristics table are guaranteed. Other parametric values quoted in this data sheet are provided for guidance.*