

Application:

Intel LGA1156 Core i7-800(45nm 95W)
 Intel LGA1156 Nehalem(45nm 95W) / Westmere
 (32nm 87W) CPU Lynnfield & Clarkdale sequence
 (Low Profile M/B mounting hole pitch 75x 75mm)

Picture:

Thermal & Mechanical Spec.:

Thermal performance for 95W & 87W CPU
 HSK Assembly Weight: 252 g (ref.)
 Clipping Force: 15.9 Kgf (ref.)



Component Specification:

1. Heat Sink

Type: Thermal Shrink with Cu Core
 Material: Aluminum A6063 & Copper C1100
 or Equivalent.

Dimension: 90*90*19.05 mm

2. Thermal interface material

 Material: Dow Corning TC-111 or Equivalent.

3. Fan

(90x90x25 mm with Thermistor & PWM Control)

Rated Voltage: 12 V

Life Time:

Superflo bearing 50000 hrs

Connector:

a. Lead wire: UL 10368 AWG #26 

pin 1: black wire-----(-)

pin 2: yellow wire-----(+)

pin 3: green wire----- (F00)

pin 4: blue wire----- (PWM)

b. Housing: Molex 47054-1000 or equivalent

c. Terminal: Molex 2759T 08-50-0113 or equivalent

* All readings are typical values at rated voltage.

* Specifications are subject to change without notice





APPROVAL SHEET

Customer Name .:

Model Name.:

COOLER

Model Name.:

FHS-A9025S19

Customer Part No.:

Spec Issue Date .:

10/25/2015

Spec Revision :

07

PLEASE SEND ONE COPY OF THIS SPECIFICATION BACK AFTER YOU
SIGNED APPROVAL FOR PRODUCTION PRE-ARRANGMENT.

Approved By:

Date:

Approval	Check	Designer
Alex-Hsia	Charles Chen	Skyler-Huang



Delta Electronics Corp.

REV.	Description	Drawn	Checked	Approved	Issue Date
00	ISSUE SPEC	Skyler-Huang03/19'10	Charles Chen03/19'10	Alex-Hsia 03/19'10	
01	1.The wire is changed from UL 10368 AWG#22 to UL 10368 AWG#26	HIKARU 06/15'11	Charles Chen06/15'11	Alex-Hsia 06/15'11	
02	1.Add RoHS Certification	HIKARU 09/21'11	Charles Chen09/21'11	Alex-Hsia 09/22'11	
03	1. Modify the Package spec 2. Modify Fan label on Page 7 3. Change the Fan P/N	Skyler-Huang07/13'12	Charles Chen07/13'12	Alex-Hsia 07/13'12	
04	1. Modify HSK cross cutting feature on Page 1 &7&10	Skyler-Huang09/03'12	Charles Chen09/03'12	Alex-Hsia 09/03'12	
05	1.Modify the Package spec 2.Change the Fan P/N 3.Updated the Rohs 4.Modify the cable length to 250mm	Skyler-Huang 6/10'13	Charles Chen06/10'13	Alex-Hsia 06/10'13	
06	1.Updated the RoHS	Reek.Li 10/17/'13	Charles Chen10/17/'13	Charles Chen10/17/'13	
07	1. Change TIM from TC-1996 to TC-5630 2. Update TC-5630 RoHS	Skyler.Huang10/25'15	Charles Chen10/25'15	Charles Chen10/25'15	
Description: SAMPLE REVISION CODE LIST					
Part No.					REV
DELTA MODEL : FHS-A9025S19			TOTAL 97 PAGE		07



Delta Electronics Corp.

CONTENTS

Item	Element Description	Page	Note
1	Specification	5	
2	Print	6	
3	Packing Plan	12	
4	Fan Specification	15	
5	RoHS Certification	26	



Delta Electronics Corp.

2. PRINT

Assembly Drawing

Parts Drawing

DRAWING:

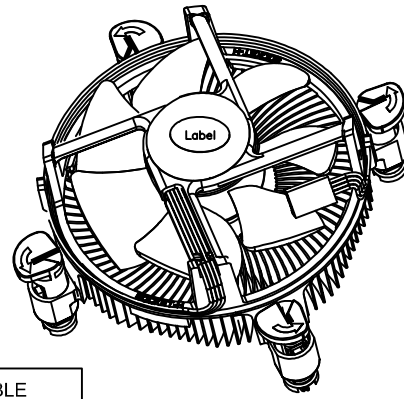
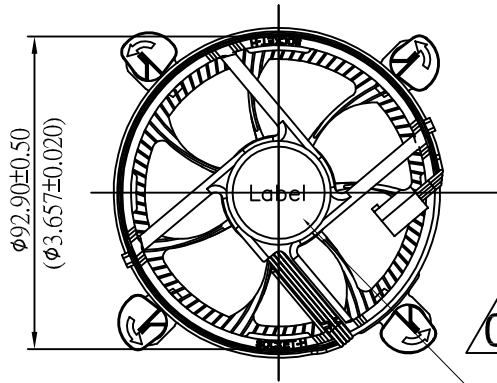

05

MODIFY THE CABLE LENGTH FROM 360MM TO 250 MM

FAN LABEL P/N:3266799400

3

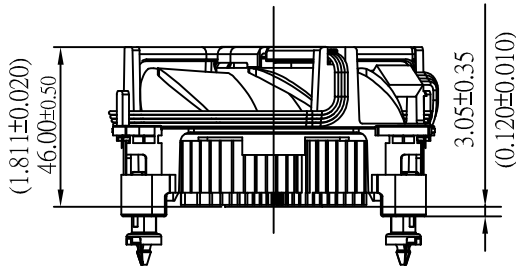

(0.787 ± 0.039)
 20.00 ± 1.00

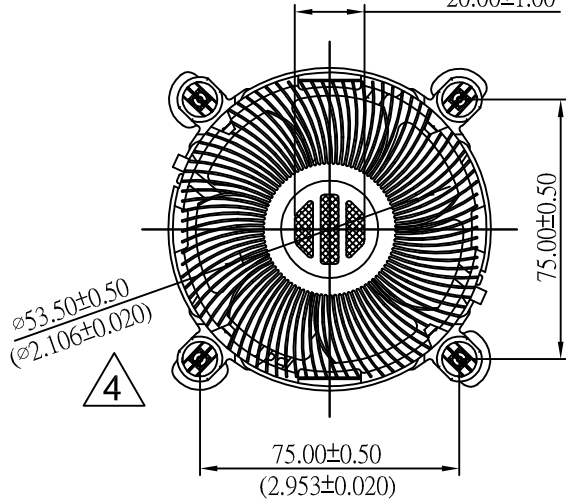

4

07

Dow Corning TC-5630 P/N:4021107300

*STENCIL THICKNESS=0.20(TYP.) 0.22(MAX.)

TIM WEIGHT ON HSK MUST BE 112mg+/-25mg

UNIT: $\frac{\text{mm}}{\text{(INCH)}}$



台達電子工業股份有限公司
DELTA ELECTRONICS, INC.

DELTA MODEL:
FHS-A9025S19

Drawn:
Skyler Huang

THESE DRAWINGS AND SPECIFICATIONS ARE THE PROPERTY OF DELTA ELECTRONICS, INC. AND SHALL NOT BE REPRODUCED OR USED AS THE BASIS FOR THE MANUFACTURE OR SELL OF APPARATUSES OR DEVICES WITHOUT PERMISSION.

CUSTOMER NAME: -----
CUSTOMER P/N: -----

DIMENSIONAL TOLERANCES		HOLES : ±0.05		ANGLES : ±0.5°	
()	()	()	()	()	()
<30	±0.25	DECIMALS	UP~100 ±0.2	250~300 ±0.4	UP~800 ±1.5
>30~100	±0.35	X	±0.3	100~150 ±0.25	300~350 ±0.45
>100~300	±0.5	XX	±0.2	150~200 ±0.3	350~400 ±0.5
ABOVE 300	±0.6	XXX	±0.1	200~250 ±0.35	900~OVER ±3.1



Description: PRODUCTION SPEC.
(PHYSICAL DIMENSION)

A4
SIZE

Part No.
FHS-A9025S19-PD

REV.

SCALE --- UNIT mm USED ON COOLER

SHEET 1 OF 2 ISSUE DATE:

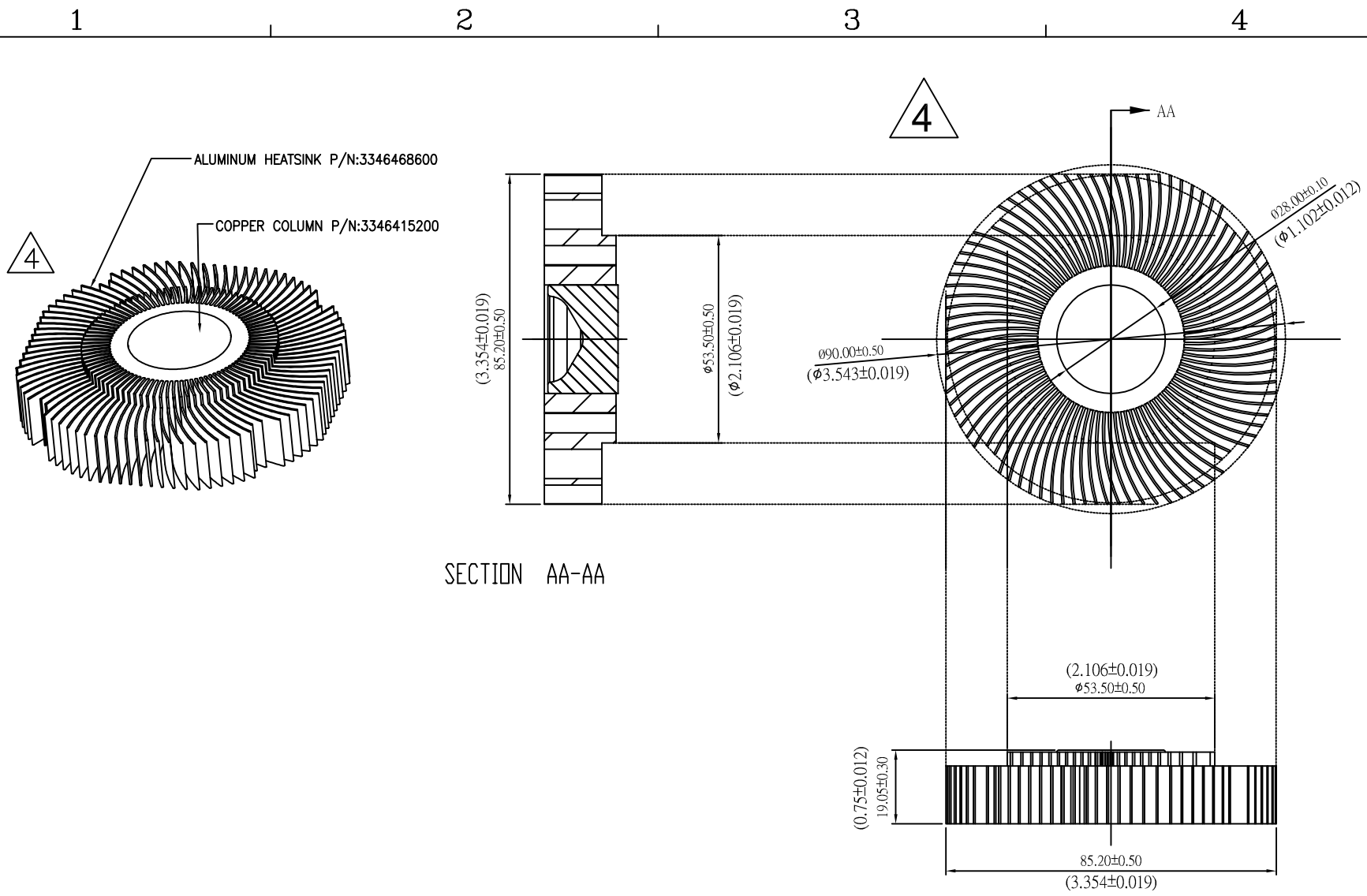

NOTE

1. MATERIAL : AL A6063 T5 & Cu1100.
2. UNLESS OTHERWISE SPECIFIED – ALL ROUNDS & FILLETS R0.1, AND BURRS & SHARP EDGES TO BE WITHIN 0.1.
3. APPEARANCE OF SURFACES TO BE UNIFORM, AND FREE OF DUST, METAL FLAKES, ADHESIVES, OIL, BLEMISHES AND SCRATCHES.

台達電子工業股份有限公司 DELTA ELECTRONICS, INC.		Drawn: Skyler Huang	
THESE DRAWINGS AND SPECIFICATIONS ARE THE PROPERTY OF DELTA ELECTRONICS, INC. AND SHALL NOT BE REPRODUCED OR USED AS THE BASIS FOR THE MANUFACTURE OR SELL OF APPARATUS OR DEVICES WITHOUT PERMISSION.		DESCRIPTION: HEATSINK	
DIMENSIONAL TOLERANCES ($(\)$) ± 0.25 DECIMALS UP-100 ± 0.2 250-300 ± 0.4 UP-600 ± 1.5 ((\checkmark)) ± 0.3 X ± 0.5 100-150 ± 0.25 300-350 ± 0.45 600-900 ± 2.4 (>100-300 ± 0.5 XX ± 0.8 150-200 ± 0.5 350-400 ± 0.5 900-OVER ± 3.1 ABOVE 300 ± 0.6 XXX ± 0.1 300-250 ± 0.35		PART NO.: 3345114400 REV. --	
SCALE 1/1 UNIT mm USED ON COOLER	A4 SIZE		SHEET 2 OF 2



Delta Electronics Corp.

3. PACKING PLAN

Packing Specification

CARTON ILLUSTRATE	SIZE	524(L)*225(w)*475(H)(mm)	PACKING QUANTITY	6LAYERS/CARTON
	MATERIAL	3 LAYERS"AB" FLUTE	CARTON WEIGHT	0.62 kg (REF.)

CARTON OUTSIDE ILLUSTRATE

FRONT

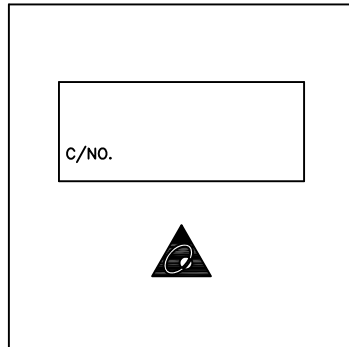

BACK

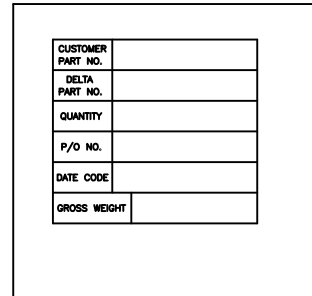

(ONE LABEL PER CARTON)

PET TRAY PACKING ILLUSTRATE	SIZE	94(L)*94(w)*30(H)(mm)	PACKING QUANTITY	1PCS/PET TRAY
	MATERIAL	PET TRAY		
	MATERIAL WEIGHT	6g (REF.)		



CARTON

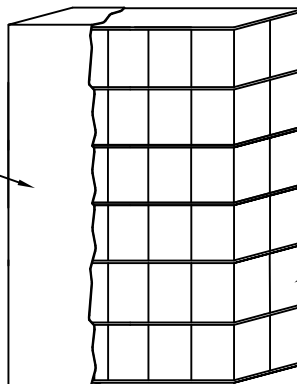

PAPER PAD(7X)

BOX(60X)



台達電子工業股份有限公司
DELTA ELECTRONICS, INC.

DELTA MODEL:
FHS-A9025S19

Drawn:
Skyler Huang

THESE DRAWINGS AND SPECIFICATIONS ARE THE PROPERTY OF DELTA ELECTRONICS, INC. AND SHALL NOT BE REPRODUCED OR USED AS THE BASIS FOR THE MANUFACTURE OR SELL OF APPARATUS OR DEVICES WITHOUT PERMISSION.

CUSTOMER NAME: -----

CUSTOMER P/N: -----

DIMENSIONAL TOLERANCES		HOLES : ±0.05		ANGLES : ±0.5°	
()	()	()	()	()	()
<30	±0.25	DECIMALS	UP~100 ±0.2	250~300 ±0.4	UP~600 ±1.5
>30~100	±0.35	X	±0.3	100~150 ±0.25	300~350 ±0.45
>100~300	±0.5	XX	±0.2	150~200 ±0.3	350~400 ±0.5
ABOVE 300	±0.6	XXX	±0.1	200~250 ±0.35	900~OVER ±3.1



Description: PRODUCTION SPEC.
(PACKING ASSMBLY)

A4
SIZE

Part No.
FHS-A9025S19-PA

REV.

SCALE --- UNIT mm USED ON COOLER

SHEET 1 OF 2 ISSUE DATE:

PART NO.	FHS-A9025S19		
BASIC DATA	QUANTITY/CARTON	60PCS (6 LAYERS/CARTON, 10PCS/LAYER) 	
	PRODUCTION NET WEIGHT	15.1kg (REF.)	
	PRODUCTION GROSS WEIGHT	17.8kg (REF.)	
20(ft)CONTAINER ILLUSTRATE	SIZE	5.889(L)*2.352(w)*2.386(H)m	PACKING QUANTITY
	CONTAINER	STEEL	20PALLET/CONTAINER

CONTAINER FORM

CONTAINER LOADING MATHOD

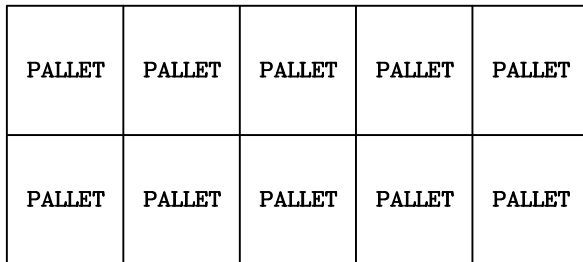

TOP VIEW

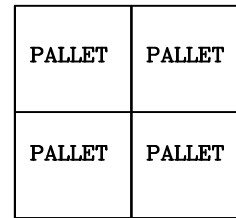

FRONT VIEW

PALLET LOADING ILLUSTRATE	SIZE	117(L)*107(w)*13(H)cm	PACKING QUANTITY	20 CARTONS/PALLET
	PALLET	WOOD		

PALLET ILLUSTRATE

PALLET LOADING MATHOD

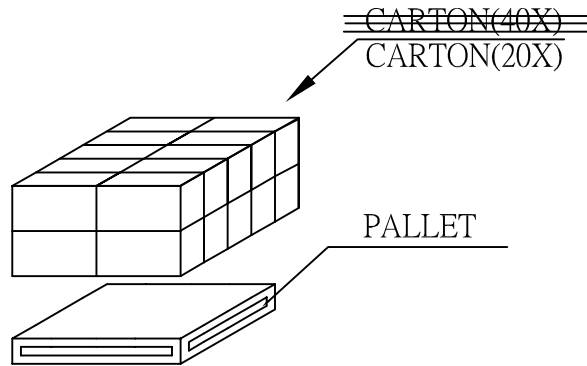

台達電子工業股份有限公司
DELTA ELECTRONICS, INC.

DELTA MODEL:
FHS-A9025S19

Drawn:
Skyler Huang

THESE DRAWINGS AND SPECIFICATIONS ARE THE PROPERTY OF DELTA ELECTRONICS, INC. AND SHALL NOT BE REPRODUCED OR USED AS THE BASIS FOR THE MANUFACTURE OR SELL OF APPARATUSES OR DEVICES WITHOUT PERMISSION.

CUSTOMER NAME: -----
CUSTOMER P/N: -----

DIMENSIONAL TOLERANCES		HILES : ±0.05	ANGLES : ±0.5°
()	()	()	()
<30 :±0.25	DECIMALS	UP~100 :±0.2	250~300 :±0.4
>30~100 :±0.35	X :±0.3	100~150 :±0.25	300~350 :±0.45
>100~300 :±0.5	XX :±0.2	150~200 :±0.3	350~400 :±0.5
ABOVE 300 :±0.6	XXX :±0.1	200~250 :±0.35	900~OVER :±3.1

Description: PRODUCTION SPEC.
(PACKING ASSMEBLY)

A4 Part No. FHS-A9025S19-PA

REV.

SCALE --- UNIT mm USED ON COOLER

SIZE SHEET 2 OF 2 ISSUE DATE:



Delta Electronics Corp.

4. FAN

Fan Specification



SPECIFICATION FOR APPROVAL

Customer TMPBU

Description DC FAN

Part No. _____ REV. _____

Delta Model No. AUC0912D-DB55 REV. 00

Sample Issue No. _____

Sample Issue Date FEB.21.2013

PLEASE SEND ONE COPY OF THIS SPECIFICATION BACK
AFTER YOU SIGNED APPROVAL FOR PRODUCTION PRE-
ARRANGMENT.

APPROVED BY: _____

DATE : _____

DELTA ELECTRONICS, INC.
TAOYUAN PLANT
252, SHANG YING ROAD, KUEI SAN INDUSTRIAL ZONE TAOYUAN
SHIEN, TAIWAN, R.O.C.
TEL:886-(0)3-3591968
FAX:886-(0)3-3591991

DELTA ELECTRONICS, INC.
 252, SHANG YING ROAD, KUEI SAN
 TAOYUAN HSIEN 333, TAIWAN, R. O. C.

TEL : 886-(0)3-3591968
 FAX : 886-(0)3-3591991

SPECIFICATION FOR APPROVAL

Customer: TMPBU

 Description: DC FAN

 Customer P/N: REV:

 Delta Model NO.: AUC0912D-DB55 Delta Safety Model NO.: AUC0912D-8L2V

 Sample Rev: 00 Issue NO:

 Sample Issue Date: FEB.21.2013 Quantity:

1. SCOPE:

THIS SPECIFICATION DEFINES THE ELECTRICAL AND MECHANICAL CHARACTERISTICS OF THE DC BRUSHLESS AXIAL FLOW FAN. THE FAN MOTOR IS WITH SINGLE PHASES AND FOUR POLES.

2. CHARACTERS:

ITEM	DESCRIPTION	
SENSOR TEMPERATURE	30°C	40°C
RATED VOLTAGE	12.0 VDC	
OPERATION VOLTAGE	10.8 - 13.2 VDC	
START UP CURRENT	MAX. 0.60A	MAX. 0.75A
INPUT CURRENT	0.07 (MAX. 0.14) A (CURRENT ON SAFETY LABEL 0.60A)	0.16 (MAX. 0.60) A (CURRENT ON SAFETY LABEL 0.60A)
INPUT POWER	0.84 (MAX. 1.68) W	1.68 (MAX. 7.20) W
SPEED (FAN ONLY)	2050±10% R.P.M.	3200±10% R.P.M.
SPEED (FAN ON SINK)	2000±10% R.P.M.	3150±10% R.P.M.
MAX. AIR FLOW (FAN ONLY) (AT ZERO STATIC PRESSURE)	0.537 (MIN. 0.483) M ³ /MIN. 18.96 (MIN. 17.06) CFM	0.914 (MIN. 0.823) M ³ /MIN. 32.29 (MIN. 29.06) CFM
MAX. AIR PRESSURE (FAN ONLY) (AT ZERO AIRFLOW)	1.53 (MIN. 1.24) mmH ₂ O 0.060 (MIN. 0.049) inchH ₂ O	3.61 (MIN. 2.92) mmH ₂ O 0.142 (MIN. 0.115) inchH ₂ O
ACOUSTICAL NOISE(ON SINK AVG.)	26.0 (MAX. 30.0) dB-A	36.0 (MAX. 40.0) dB-A
INSULATION TYPE	UL: CLASS A	

(continued)

PART NO:

DELTA MODEL: AUC0912D-DB55

INSULATION STRENGTH	10 MEG OHM MIN. AT 500 VDC (BETWEEN FRAME AND (+) TERMINAL)
DIELECTRIC STRENGTH	5 mA MAX. AT 500 VAC 50/60 Hz ONE MINUTE, (BETWEEN FRAME AND (+) TERMINAL)
EXTERNAL COVER	OPEN TYPE
LIFE EXPECTANCE (AT LABEL VOLTAGE)	80,000 HOURS CONTINUOUS OPERATION AT 45 °C WITH 15 ~ 65 %RH.
ROTATION	CLOCKWISE VIEW FROM NAME PLATE SIDE
OVER CURRENT SHUT DOWN	THE CURRENT WILL SHUT DOWN WHEN LOCKING ROTOR
LEAD WIRE	UL 10368 -F- AWG #26 BLACK WIRE:NEGATIVE(-) YELLOW WIRE:POSITIVE(+) GREEN WIRE:TACHOMETER OUTPUT (F00) BLUE WIRE:SPEED CONTROL (PWM)

- NOTES: 1. ALL READINGS ARE MEASURED AFTER STABLY WARMING UP THROUGH 10 MINUTES.
2. STANDARD AIR PROPERTY IS AIR AT (Td) 25°C TEMPERATURE, (RH) 65% RELATIVE HUMIDITY, AND (Pb) 760 mmHg BAROMETRIC PRESSURE.
3. THE VALUES WRITTEN IN PARENS , (), ARE LIMITED SPEC.
4. ACOUSTICAL NOISE MEASURING CONDITION:

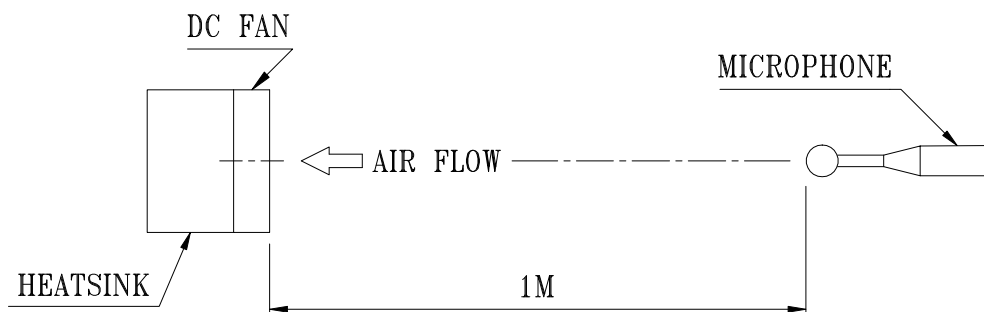

NOISE IS MEASURED AT RATED VOLTAGE IN FREE AIR IN ANECHOIC CHAMBER WITH B & K SOUND LEVEL METER WITH MICROPHONE AT A DISTANCE OF ONE METER FROM THE FAN INTAKE.

PART NO:

DELTA MODEL: AUC0912D-DB55

3. MECHANICAL:

- 3-1. DIMENSIONS ----- SEE DIMENSIONS DRAWING
- 3-2. FRAME ----- PLASTIC UL: 94V-0
(THE HALOGEN SUBSTANCE CONTENT IS LESS THAN 1500 PPM FOR USING EDX ...ETC)
- 3-3. IMPELLER ----- PLASTIC UL: 94V-0
(THE HALOGEN SUBSTANCE CONTENT IS LESS THAN 1500 PPM FOR USING EDX ...ETC)
- 3-4. BEARING SYSTEM ----- SUPERFLO BEARING
- 3-5. WEIGHT ----- 82 GRAMS

4. ENVIRONMENTAL:

- 4-1. OPERATING TEMPERATURE ----- -10 TO +70 DEGREE C
- 4-2. STORAGE TEMPERATURE ----- -35 TO +80 DEGREE C
- 4-3. OPERATING HUMIDITY --- 85% RELATIVE HUMIDITY WITH 55 DEGREE C
- 4-4. STORAGE HUMIDITY ----- 5 TO 95 % RH

5. PROTECTION:

- 5-1. LOCKED ROTOR PROTECTION
IMPEDANCE OF MOTOR WINDING PROTECTS MOTOR FROM FIRE IN 96 HOURS OF LOCKED ROTOR CONDITION AT THE RATED VOLTAGE.
- 5-2. POLARITY PROTECTION
BE CAPABLE OF WITHSTANDING IF REVERSE CONNECTION FOR POSITIVE AND NEGATIVE LEADS.

6. RE OZONE DEPLETING SUBSTANCES:

- 6-1. NO CONTAINING PBBs, PBBOs, CFCs, PBBEs, PBDPEs AND HCFCs.

7. PRODUCTION LOCATION

- 7-1. PRODUCTS WILL BE PRODUCED IN CHINA OR THAILAND .

PART NO:

DELTA MODEL: AUC0912D-DB55

8. P & Q CURVE:
PWM 100% DUTY CYCLE

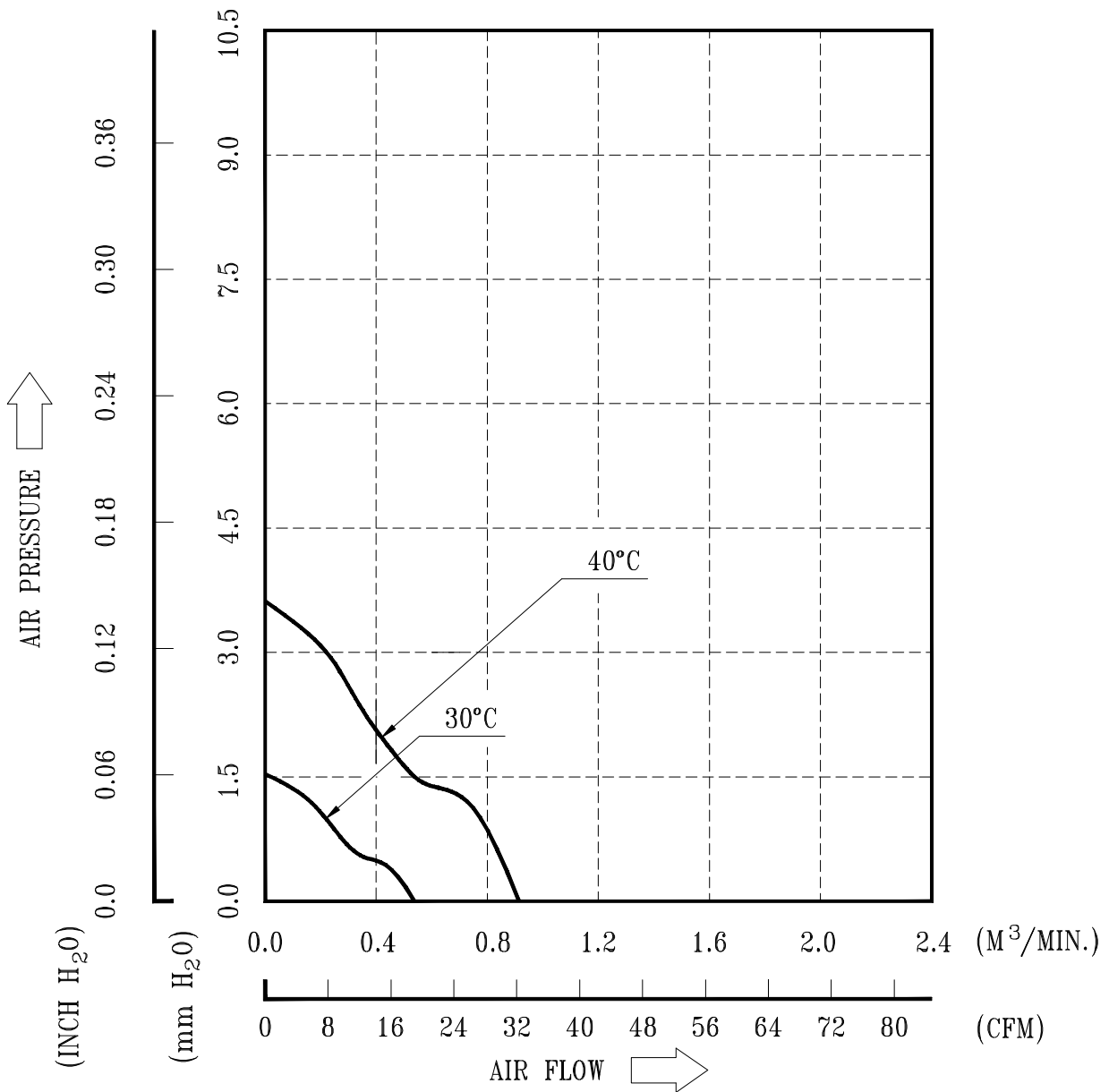

* TEST CONDITION: INPUT VOLTAGE ----- OPERATION VOLTAGE
TEMPERATURE ----- ROOM TEMPERATURE
HUMIDITY ----- 65%RH

PART NO:

DELTA MODEL: AUC0912D-DB55

9. DIMENSION DRAWING:

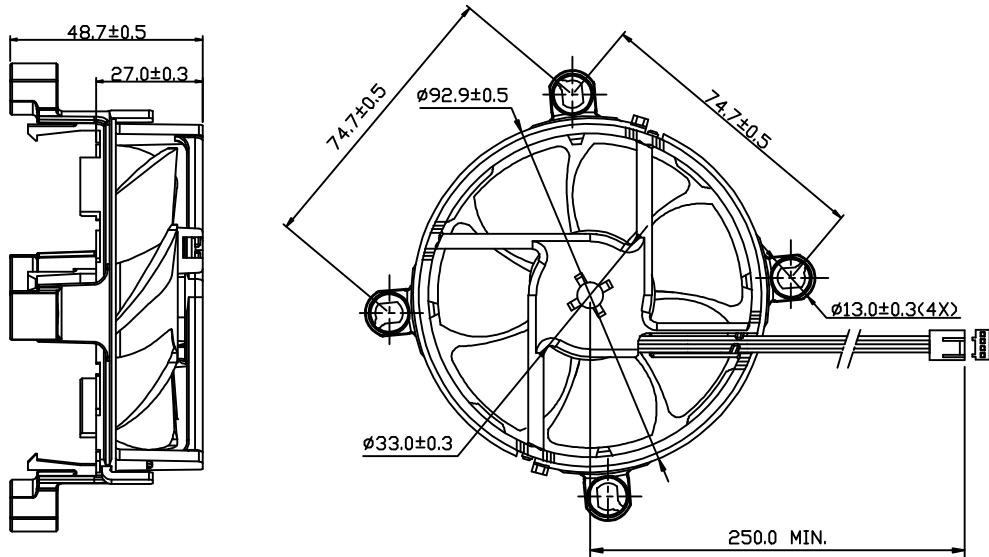

UNIT: MM

- NOTE :
1. LEAD WIRE: UL 10368 -F- AWG #26
PIN 1 : BLACK WIRE: NEGATIVE(-)
PIN 2 : YELLOW WIRE: POSITIVE(+)
PIN 3 : GREEN WIRE: TACHOMETER OUTPUT (F00)
PIN 4 : BLUE WIRE: SPEED CONTROL (PWM)
 2. HOUSING : MOLEX 47054-1000 OR EQUIVALENT
 3. TERMINAL : MOLEX 2759T 08-50-0113 OR EQUIVALENT
 4. THIS PRODUCT IS RoHS COMPLIANT
 5. DELTA'S RESTRICTIONS ON HALOGEN APPLY ONLY TO BROMINATED AND CHLORINATED COMPOUNDS. NO OTHER HALOGEN IS RESTRICTED. SUBSTANCES RESTRICTIONS FOR HALOGEN-FREE(INCLUDE FAN PLASTIC PARTS, PWB BOARD, IC, ELECTRICAL MATERIALS & CABLE ASSY),
 - a. BROMINE(Br) ≤ 900 PPM.
 - b. CHLORINE(Cl) ≤ 900 PPM.
 - c. (Br) + (Cl) ≤ 1500 PPM.

PART NO:

DELTA MODEL: AUC0912D-DB55

10. FREQUENCY GENERATOR (FG) SIGNAL:

10-1. OUTPUT CIRCUIT - OPEN DRAIN MODE:

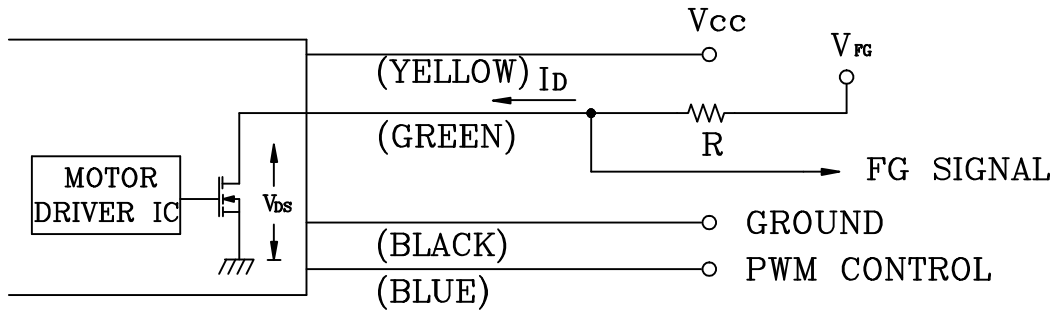

CAUTION: THE FG SIGNAL LEAD WIRE MUST BE KEPT AWAY FROM "+" LEAD WIRE & "-" LEAD WIRE.

10-2. SPECIFICATION:

V_{DS} (LINEAR)=0.5V MAX.

V_{FG} =5.0V TYP. (V_{CC} MAX.)

I_D =5mA MAX.

$R \geq V_{FG} / I_D$

10-3. FREQUENCY GENERATOR WAVEFORM:

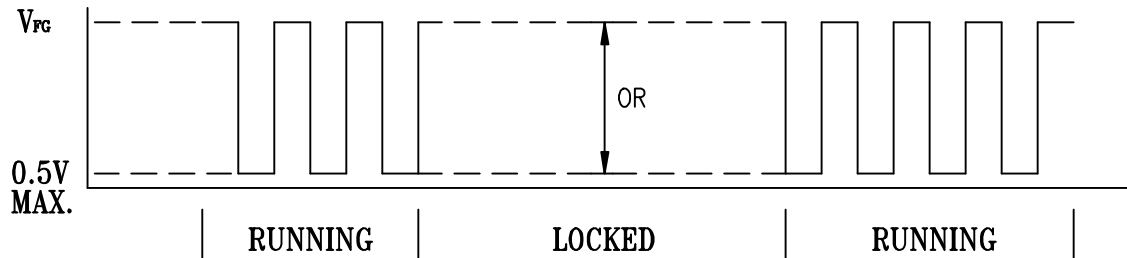

FAN RUNNING FOR 4 POLES

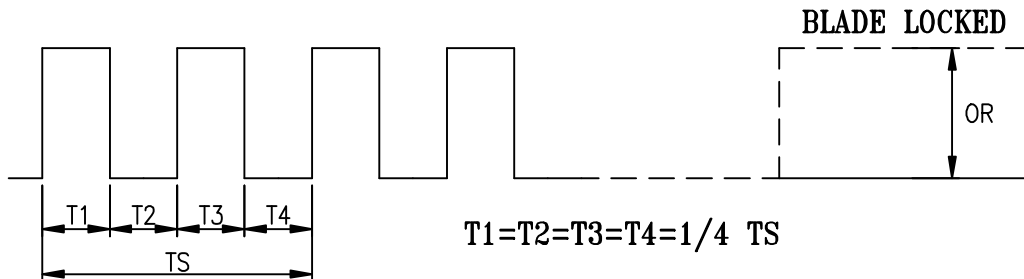

$N=R.P.M$

$TS=60/N(SEC)$

*VOLTAGE LEVEL AFTER BLADE LOCKED

*4 POLES

A00

PART NO:

DELTA MODEL: AUC0912D-DB55

11. PWM CONTROL FUNCTION:(FAN ON SINK)

11-1 SIGNAL DESCRIPTION:

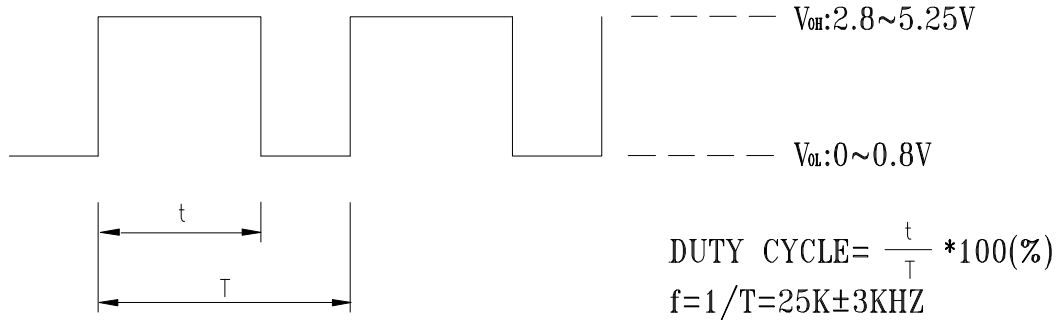

- AT 25K HZ 30% DUTY CYCLE ,THE FAN WILL BE ABLE TO START FROM A DEAD STOP .

11-2 SPEED CONTROL

TEST CONDITION : INPUT VCC=12V PWM FREQUENCY=25KHZ

11-2-1 TEMPERATURE CONTROL

BELOW 30 DEGREE C,THE FAN SPEED IS 2000RPM.

ABOVE 40 DEGREE C,THE FAN SPEED IS 3150RPM.

BETWEEN 30~40 DEGREE C,THE FAN SPEED IS 2000RPM~3150RPM.

11-2-2 PWM CONTROL

BELOW 30 DEGREE C

BETWEEN 0%~20% TO 100% DUTY CYCLE,THE FAN SPEED IS 1000RPM TO 2000RPM.

ABOVE 40 DEGREE C

BETWEEN 0%~20% TO 100% DUTY CYCLE,THE FAN SPEED IS 1000RPM TO 3150RPM.

TEMPERATURE (°C)	DUTY CYCLE (%)	SPEED (R.P.M.)
30	0~20	1000±200
30	100	2000±10%
40	0~20	1000±200
40	100	3150±10%

- IF THE CONTROL SIGNAL IS DISCONNECT THE FAN WILL GO TO TEMPERATURE CONTROL SPEED.

PART NO:

DELTA MODEL: AUC0912D-DB55

12. PWM CONTROL FUNCTION:(FAN ONLY)

12-1 SIGNAL DESCRIPTION:

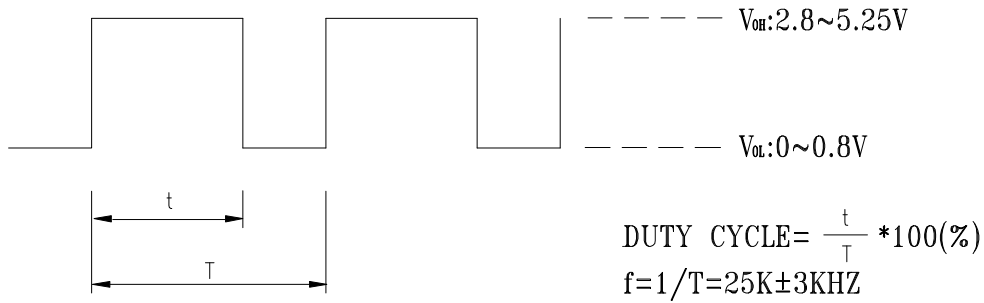

- AT 25K HZ 30% DUTY CYCLE ,THE FAN WILL BE ABLE TO START FROM A DEAD STOP .

12-2 SPEED CONTROL

TEST CONDITION : INPUT VCC=12V PWM FREQUENCY=25KHZ

12-2-1 TEMPERATURE CONTROL

BELOW 30 DEGREE C,THE FAN SPEED IS 2050RPM.

ABOVE 40 DEGREE C,THE FAN SPEED IS 3200RPM.

BETWEEN 30~40 DEGREE C,THE FAN SPEED IS 2050RPM~3200RPM.

12-2-2 PWM CONTROL

BELOW 30 DEGREE C

BETWEEN 0%~20% TO 100% DUTY CYCLE,THE FAN SPEED IS 1000RPM TO 2050RPM.

ABOVE 40 DEGREE C

BETWEEN 0%~20% TO 100% DUTY CYCLE,THE FAN SPEED IS 1000RPM TO 3200RPM.

TEMPERATURE (°C)	DUTY CYCLE (%)	SPEED (R.P.M.)
30	0~20	1000±200
30	100	2050±10%
40	0~20	1000±200
40	100	3200±10%

- IF THE CONTROL SIGNAL IS DISCONNECT THE FAN WILL GO TO TEMPERATURE CONTROL SPEED.

13. PWM CONTROL LEAD WIRE INPUT IMPEDANCE:

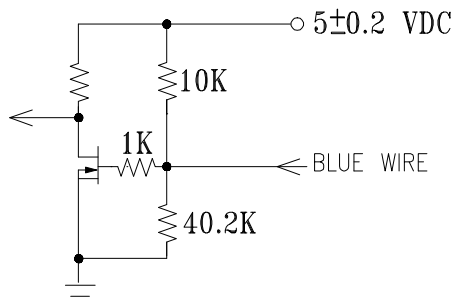

Application Notice

- 1. Delta will not guarantee the performance of the products if the application condition falls outside the parameters set forth in the specification.**
- 2. A written request should be submitted to Delta prior to approval if deviation from this specification is required.**
- 3. Please exercise caution when handling fans. Damage may be caused when pressure is applied to the impeller, if the fans are handled by the lead wires, or if the fan was hard-dropped to the production floor.**
- 4. Except as pertains to some special designs, there is no guarantee that the products will be free from any such safety problems or failures as caused by the introduction of powder, droplets of water or encroachment of insect into the hub.**
- 5. The above-mentioned conditions are representative of some unique examples and viewed as the first point of reference prior to all other information.**
- 6. It is very important to establish the correct polarity before connecting the fan to the power source. Positive (+) and Negative (-). Damage may be caused to the fans if connection is with reverse polarity, if there is no foolproof method to protect against such error specifically mentioned in this spec.**
- 7. Delta fans without special protection are not suitable where any corrosive fluids are introduced to their environment.**
- 8. Please ensure all fans are stored according to the storage temperature limits specified. Do not store fans in a high humidity environment. We highly recommend performance testing is conducted before shipping, if the fans have been stored over 6 months.**
- 9. Not all fans are provided with the Lock Rotor Protection feature. If you impair the rotation of the impeller for the fans that do not have this function, the performance of those fans will lead to failure.**
- 10. Please be cautious when mounting the fan. Incorrect mounting of fans may cause excess resonance, vibration and subsequent noise.**
- 11. It is important to consider safety when testing the fans. A suitable fan guard should be fitted to the fan to guard against any potential for personal injury.**
- 12. Except where specifically stated, all tests are carried out at room (ambient) temperature and relative humidity conditions of 25°C, 65% RH. The test value is only for fan performance itself.**
- 13. Be certain to connect an “ 4.7 μ F or greater” capacitor to the fan externally when the application calls for using multiple fans in parallel, to avoid any unstable power.**



Delta Electronics Corp.

5. Material Certification

5.1. PBT

5.2. AL6063-T5

5.3. CU 1100

5.4. PC

5.5. PET 、 INK 、 COATING

5.6. DOW TC-5630

Test Report

No. CANEC1308566601

Date: 09 Jun 2013

Page 1 of 14

KINGFA SCI. & TECH. CO., LTD.

NO.33 KEFENG ROAD,SCIENCE CITY,GUANGZHOU HI-TECHINDUSTRIAL DEVELOPMENT
ZONE,GUANGZHOU CITY
CHINA

The following sample(s) was/were submitted and identified on behalf of the clients as : PBT-NPG30

SGS Job No. : CP13-029439 - GZ

Date of Sample Received : 06 Jun 2013

Testing Period : 06 Jun 2013 - 09 Jun 2013

Test Requested : Selected test(s) as requested by client.

Test Method : Please refer to next page(s).

Test Results : Please refer to next page(s).

Conclusion : Based on the performed tests on submitted samples, the results of Lead, Mercury, Cadmium, Hexavalent chromium, Polybrominated biphenyls (PBB), Polybrominated diphenyl ethers (PBDE) comply with the limits as set by RoHS Directive 2011/65/EU Annex II; recasting 2002/95/EC.

Signed for and on behalf of
SGS-CSTC Ltd.



Merry Lv
Approved Signatory

This document is issued by the Company subject to its General Conditions of Service printed overleaf, available on request or accessible at http://www.sgs.com/terms_and_conditions.htm and, for electronic format documents, subject to Terms and Conditions for Electronic Documents at www.sgs.com/terms_e-document.htm. Attention is drawn to the limitation of liability, indemnification and jurisdiction issues defined therein. Any holder of this document is advised that information contained hereon reflects the Company's findings at the time of its preparation only, and within the limits of Client's instructions, if any. The Company's sole responsibility is to its Client and this document does not exonerate parties to a transaction from exercising all their rights and obligations under the transaction documents. This document cannot be reproduced except in full, without prior written approval of the Company. Any unauthorized alteration, forgery or falsification of the content or appearance of this document is unlawful and offenders may be prosecuted to the fullest extent of the law. Unless otherwise stated, the results shown in this test report refer only to the sample(s) tested.

Test Results :

Test Part Description :

Specimen No.	SGS Sample ID	Description
1	CAN13-085666.001	Black plastic grains

Remarks :

- (1) 1 mg/kg = 1 ppm = 0.0001%
- (2) MDL = Method Detection Limit
- (3) ND = Not Detected (< MDL)
- (4) "-" = Not Regulated

RoHS Directive 2011/65/EU

Test Method : With reference to IEC 62321:2008

- (1) Determination of Cadmium by ICP-OES.
- (2) Determination of Lead by ICP-OES.
- (3) Determination of Mercury by ICP-OES.
- (4) Determination of Hexavalent Chromium by Colorimetric Method using UV-Vis.
- (5) Determination of PBBs / PBDEs content by GC-MS.

Test Item(s)	Limit	Unit	MDL	001
Cadmium (Cd)	100	mg/kg	2	ND
Lead (Pb)	1,000	mg/kg	2	ND
Mercury (Hg)	1,000	mg/kg	2	ND
Hexavalent Chromium (CrVI)	1,000	mg/kg	2	ND
Sum of PBBs	1,000	mg/kg	-	ND
Monobromobiphenyl	-	mg/kg	5	ND
Dibromobiphenyl	-	mg/kg	5	ND
Tribromobiphenyl	-	mg/kg	5	ND
Tetrabromobiphenyl	-	mg/kg	5	ND
Pentabromobiphenyl	-	mg/kg	5	ND
Hexabromobiphenyl	-	mg/kg	5	ND
Heptabromobiphenyl	-	mg/kg	5	ND
Octabromobiphenyl	-	mg/kg	5	ND
Nonabromobiphenyl	-	mg/kg	5	ND
Decabromobiphenyl	-	mg/kg	5	ND
Sum of PBDEs	1,000	mg/kg	-	ND
Monobromodiphenyl ether	-	mg/kg	5	ND

This document is issued by the Company subject to its General Conditions of Service printed overleaf, available on request or accessible at http://www.sgs.com/terms_and_conditions.htm and, for electronic format documents, subject to Terms and Conditions for Electronic Documents at www.sgs.com/terms_e-document.htm. Attention is drawn to the limitation of liability, indemnification and jurisdiction issues defined therein. Any holder of this document is advised that information contained hereon reflects the Company's findings at the time of its preparation only and within the limits of Client's instructions, if any. The Company's sole responsibility is to its Client and this document does not exonerate parties to a transaction from exercising all their rights and obligations under the transaction documents. This document cannot be reproduced except in full, without prior written approval of the Company. Any unauthorized alteration, forgery or falsification of the content or appearance of this document is unlawful and offenders may be prosecuted to the fullest extent of the law. Unless otherwise stated, the results shown in this test report refer only to the sample(s) tested.

Test Report

No. CANEC1308566601

Date: 09 Jun 2013

Page 3 of 14

<u>Test Item(s)</u>	<u>Limit</u>	<u>Unit</u>	<u>MDL</u>	<u>001</u>
Dibromodiphenyl ether	-	mg/kg	5	ND
Tribromodiphenyl ether	-	mg/kg	5	ND
Tetrabromodiphenyl ether	-	mg/kg	5	ND
Pentabromodiphenyl ether	-	mg/kg	5	ND
Hexabromodiphenyl ether	-	mg/kg	5	ND
Heptabromodiphenyl ether	-	mg/kg	5	ND
Octabromodiphenyl ether	-	mg/kg	5	ND
Nonabromodiphenyl ether	-	mg/kg	5	ND
Decabromodiphenyl ether	-	mg/kg	5	ND

Notes :

(1) The maximum permissible limit is quoted from the directive 2011/65/EU, Annex II.

Elementary Analysis

Test Method : With reference to US EPA Method 3052:1996, analysis was performed by ICP-OES.

<u>Test Item(s)</u>	<u>Unit</u>	<u>MDL</u>	<u>001</u>
Sb ₂ O ₃ ♦	mg/kg	12	ND

Notes :

(1) ♦Sb2O3: Calculate from Antimony content.

Elementary Analysis

Test Method : With reference to US EPA Method 3052:1996, analysis was performed by ICP-OES.

<u>Test Item(s)</u>	<u>Unit</u>	<u>MDL</u>	<u>001</u>
Nickel (Ni)	mg/kg	5	ND

Phthalate

Test Method : Determination of phthalates by GC-MS based on EN 14372:2004.

This document is issued by the Company subject to its General Conditions of Service printed overleaf, available on request or accessible at http://www.sgs.com/terms_and_conditions.htm and, for electronic format documents, subject to Terms and Conditions for Electronic Documents at www.sgs.com/terms_e-document.htm. Attention is drawn to the limitation of liability, indemnification and jurisdiction issues defined therein. Any holder of this document is advised that information contained hereon reflects the Company's findings at the time of its preparation only and within the limits of Client's instructions, if any. The Company's sole responsibility is to its Client and this document does not exonerate parties to a transaction from exercising all their rights and obligations under the transaction documents. This document cannot be reproduced except in full, without prior written approval of the Company. Any unauthorized alteration, forgery or falsification of the content or appearance of this document is unlawful and offenders may be prosecuted to the fullest extent of the law. Unless otherwise stated, the results shown in this test report refer only to the sample(s) tested.

Test Report

No. CANEC1308566601

Date: 09 Jun 2013

Page 4 of 14

<u>Test Item(s)</u>	<u>Unit</u>	<u>MDL</u>	<u>001</u>
Dibutyl Phthalate (DBP)	% (w/w)	0.003	ND
Benzylbutyl Phthalate (BBP)	% (w/w)	0.003	ND
Bis-(2-ethylhexyl) Phthalate (DEHP)	% (w/w)	0.003	ND
Diisononyl Phthalate (DINP)	% (w/w)	0.01	ND
Di-n-octyl Phthalate (DNOP)	% (w/w)	0.003	ND
Diisodecyl Phthalate (DIDP)	% (w/w)	0.01	ND
Diisobutyl Phthalate (DIBP)	% (w/w)	0.003	ND
Dipentyl Phthalate (DPP)	% (w/w)	0.003	ND
Di-n-hexyl Phthalate (DnHP)	% (w/w)	0.003	ND
Dicyclohexyl Phthalate (DCHP)	% (w/w)	0.003	ND

Notes :

- (1) Reference Information: Directive 2011/65/EU recasting RoHS directive 2002/95/EC:
Bis (2-ethylhexyl) phthalate (DEHP), Butyl benzyl phthalate (BBP) and Dibutyl phthalate (DBP) are considered as a priority for risk evaluation and substance restriction.

Polynuclear Aromatic Hydrocarbons (PAHs)

Test Method : With reference to ZEK 01.4-08 of German ZLS and its amendments, analysis was performed by GC-MS.

<u>Test Item(s)</u>	<u>Unit</u>	<u>MDL</u>	<u>001</u>
Naphthalene(NAP)	mg/kg	0.2	ND
Acenaphthylene(ANY)	mg/kg	0.2	ND
Acenaphthene(ANA)	mg/kg	0.2	ND
Fluorene(FLU)	mg/kg	0.2	ND
Phenanthrene(PHE)	mg/kg	0.2	ND

This document is issued by the Company subject to its General Conditions of Service printed overleaf, available on request or accessible at http://www.sgs.com/terms_and_conditions.htm and, for electronic format documents, subject to Terms and Conditions for Electronic Documents at www.sgs.com/terms_e-document.htm. Attention is drawn to the limitation of liability, indemnification and jurisdiction issues defined therein. Any holder of this document is advised that information contained hereon reflects the Company's findings at the time of its preparation only and within the limits of Client's instructions, if any. The Company's sole responsibility is to its Client and this document does not exonerate parties to a transaction from exercising all their rights and obligations under the transaction documents. This document cannot be reproduced except in full, without prior written approval of the Company. Any unauthorized alteration, forgery or falsification of the content or appearance of this document is unlawful and offenders may be prosecuted to the fullest extent of the law. Unless otherwise stated, the results shown in this test report refer only to the sample(s) tested.

Test Report

No. CANEC1308566601

Date: 09 Jun 2013

Page 5 of 14

<u>Test Item(s)</u>	<u>Unit</u>	<u>MDL</u>	<u>001</u>
Anthracene(ANT)	mg/kg	0.2	ND
Fluoranthene(FLT)	mg/kg	0.2	ND
Pyrene(PYR)	mg/kg	0.2	ND
Benzo(a)anthracene(BaA)	mg/kg	0.2	ND
Chrysene(CHR)	mg/kg	0.2	ND
Benzo(b)fluoranthene(BbF) + Benzo(j)fluoranthene(BjF)	mg/kg	0.4	ND
Benzo(k)fluoranthene(BkF)	mg/kg	0.2	ND
Benzo(e)pyrene(BeP)	mg/kg	0.2	ND
Benzo(a)pyrene(BaP)	mg/kg	0.2	ND
Indeno(1,2,3-c,d)pyrene(IPY)	mg/kg	0.2	ND
Dibenzo(a,h)anthracene(DBA)	mg/kg	0.2	ND
Benzo(g,h,i)perylene(BPE)	mg/kg	0.2	ND
Sum of 18 PAHs	mg/kg	-	ND

This document is issued by the Company subject to its General Conditions of Service printed overleaf, available on request or accessible at http://www.sgs.com/terms_and_conditions.htm and, for electronic format documents, subject to Terms and Conditions for Electronic Documents at www.sgs.com/terms_e-document.htm. Attention is drawn to the limitation of liability, indemnification and jurisdiction issues defined therein. Any holder of this document is advised that information contained hereon reflects the Company's findings at the time of its preparation only and within the limits of Client's instructions, if any. The Company's sole responsibility is to its Client and this document does not exonerate parties to a transaction from exercising all their rights and obligations under the transaction documents. This document cannot be reproduced except in full, without prior written approval of the Company. Any unauthorized alteration, forgery or falsification of the content or appearance of this document is unlawful and offenders may be prosecuted to the fullest extent of the law. Unless otherwise stated, the results shown in this test report refer only to the sample(s) tested.

ZEK 01.4-08: Restraining maximum values for products

Parameter	Category 1	Category 2	Category 3
	Material indented to be put in the mouth or material for toys with normal skin contact for children aged < 36 months	Materials those are not included in Category 1, with predictable contact with the skin longer than 30 s. (long-term skin contact).	Materials those are not included in Category 1 or 2, with predictable skin contact up to 30 s (short-term skin contact).
Benzo(a)pyrene (mg/kg)	<0.2**	1	20
Sum of 18 PAH (mg/kg)*	<0.2**	10	200

Notes:

- * = Only PAH substances >0.2 mg/kg are taken into account while calculating the sum of PAHs
- ** = In case that the maximum values exceed the limits of category 1, but are within the limits of category 2, one may confirm the suitability of the tested material which is indented to be put in the mouth by additional specific migration tests of PAH components based on DIN EN 1186ff and §64 LFGB 80.30-1. The conclusion of the migration test results must be made based on food law criteria.

Tetrabromobisphenol A (TBBP-A)

Test Method : With reference to US EPA Method 3540C:1996, analysis was performed by GC-MS&HPLC-MS.

<u>Test Item(s)</u>	<u>Unit</u>	<u>MDL</u>	<u>001</u>
Tetrabromobisphenol A (TBBP-A)	mg/kg	10	ND

Red Phosphor

Test Method : With reference to SGS In-house method (GZTC-R&D-TOP-132),, analysis was performed by PY-GC/MS, ICP-OES

<u>Test Item(s)</u>	<u>Unit</u>	<u>MDL</u>	<u>001</u>
Red Phosphor	mg/kg	500	ND

Hexabromocyclododecane (HBCDD)

Test Method : Determination of HBCDD by GC-MS based on IEC 62321:2008.

<u>Test Item(s)</u>	<u>Unit</u>	<u>MDL</u>	<u>001</u>
Hexabromocyclododecane (HBCDD)	mg/kg	10	ND

This document is issued by the Company subject to its General Conditions of Service printed overleaf, available on request or accessible at http://www.sgs.com/terms_and_conditions.htm and, for electronic format documents, subject to Terms and Conditions for Electronic Documents at www.sgs.com/terms_e-document.htm. Attention is drawn to the limitation of liability, indemnification and jurisdiction issues defined therein. Any holder of this document is advised that information contained hereon reflects the Company's findings at the time of its preparation only and within the limits of Client's instructions, if any. The Company's sole responsibility is to its Client and this document does not exonerate parties to a transaction from exercising all their rights and obligations under the transaction documents. This document cannot be reproduced except in full, without prior written approval of the Company. Any unauthorized alteration, forgery or falsification of the content or appearance of this document is unlawful and offenders may be prosecuted to the fullest extent of the law. Unless otherwise stated, the results shown in this test report refer only to the sample(s) tested.

Notes :

- (1) Reference Information: Directive 2011/65/EU recasting RoHS directive 2002/95/EC:
Hexabromocyclododecane (HBCDD) is considered as a priority for risk evaluation and substance restriction.

This document is issued by the Company subject to its General Conditions of Service printed overleaf, available on request or accessible at http://www.sgs.com/terms_and_conditions.htm and, for electronic format documents, subject to Terms and Conditions for Electronic Documents at www.sgs.com/terms_e-document.htm. Attention is drawn to the limitation of liability, indemnification and jurisdiction issues defined therein. Any holder of this document is advised that information contained hereon reflects the Company's findings at the time of its preparation only, and within the limits of Client's instructions, if any. The Company's sole responsibility is to its Client and this document does not exonerate parties to a transaction from exercising all their rights and obligations under the transaction documents. This document cannot be reproduced except in full, without prior written approval of the Company. Any unauthorized alteration, forgery or falsification of the content or appearance of this document is unlawful and offenders may be prosecuted to the fullest extent of the law. Unless otherwise stated, the results shown in this test report refer only to the sample(s) tested.

ATTACHMENTS

RoHS Testing Flow Chart

- 1) Name of the person who made testing: Michael Tso / Cutey Yu
- 2) Name of the person in charge of testing: Adams Yu / Yolanda Wei
- 3) These samples were dissolved totally by pre-conditioning method according to below flow chart (Cr⁶⁺ and PBBs/PBDEs test method excluded).

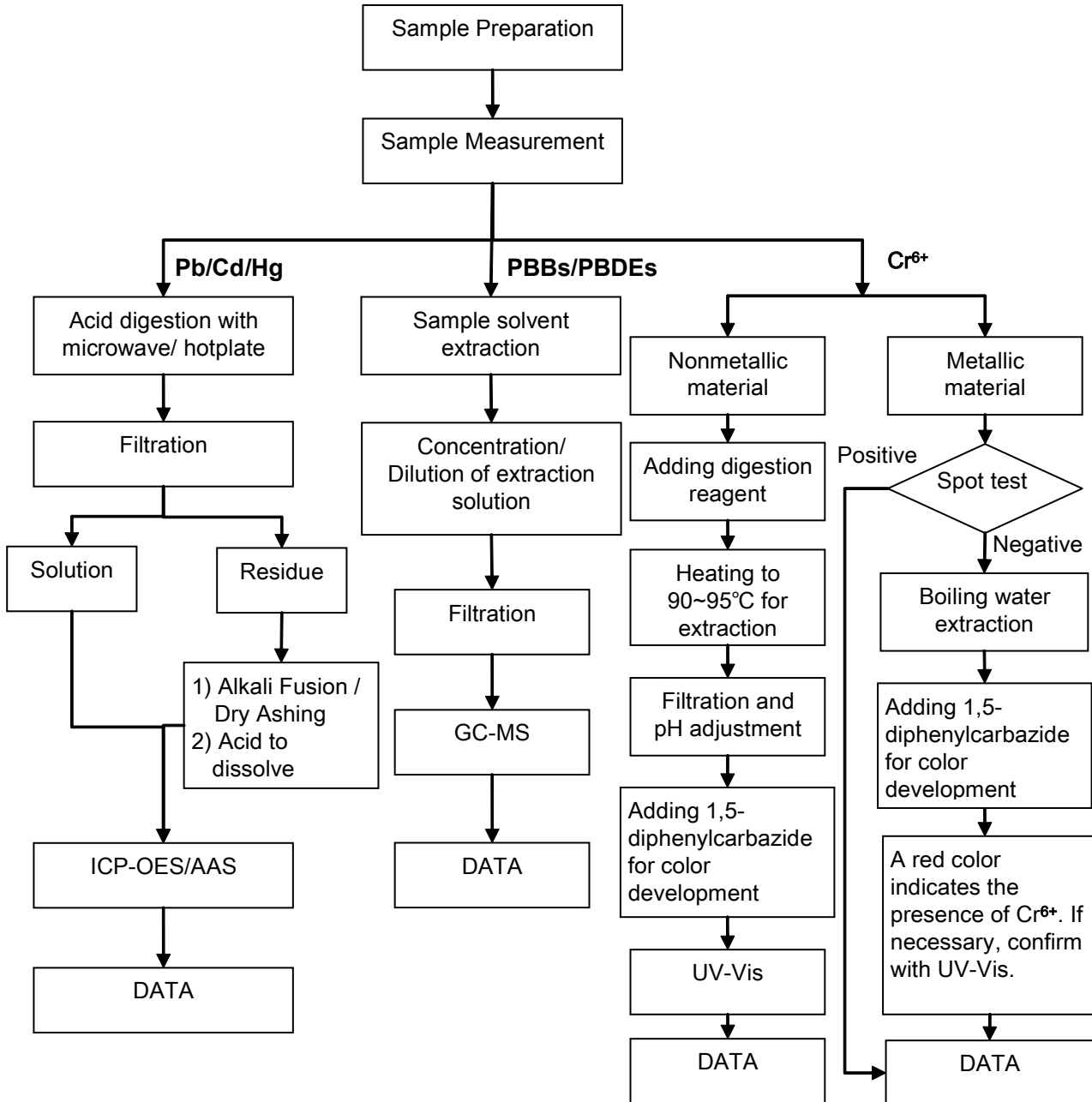

This document is issued by the Company subject to its General Conditions of Service printed overleaf, available on request or accessible at http://www.sgs.com/terms_and_conditions.htm and, for electronic format documents, subject to Terms and Conditions for Electronic Documents at www.sgs.com/terms_e-document.htm. Attention is drawn to the limitation of liability, indemnification and jurisdiction issues defined therein. Any holder of this document is advised that information contained hereon reflects the Company's findings at the time of its preparation only and within the limits of Client's instructions, if any. The Company's sole responsibility is to its Client and this document does not exonerate parties to a transaction from exercising all their rights and obligations under the transaction documents. This document cannot be reproduced except in full, without prior written approval of the Company. Any unauthorized alteration, forgery or falsification of the content or appearance of this document is unlawful and offenders may be prosecuted to the fullest extent of the law. Unless otherwise stated, the results shown in this test report refer only to the sample(s) tested.

ATTACHMENTS

HBCDD Testing Flow Chart

- 1) Name of the person who made testing: Cutey Yu
- 2) Name of the person in charge of testing: Yolanda Wei

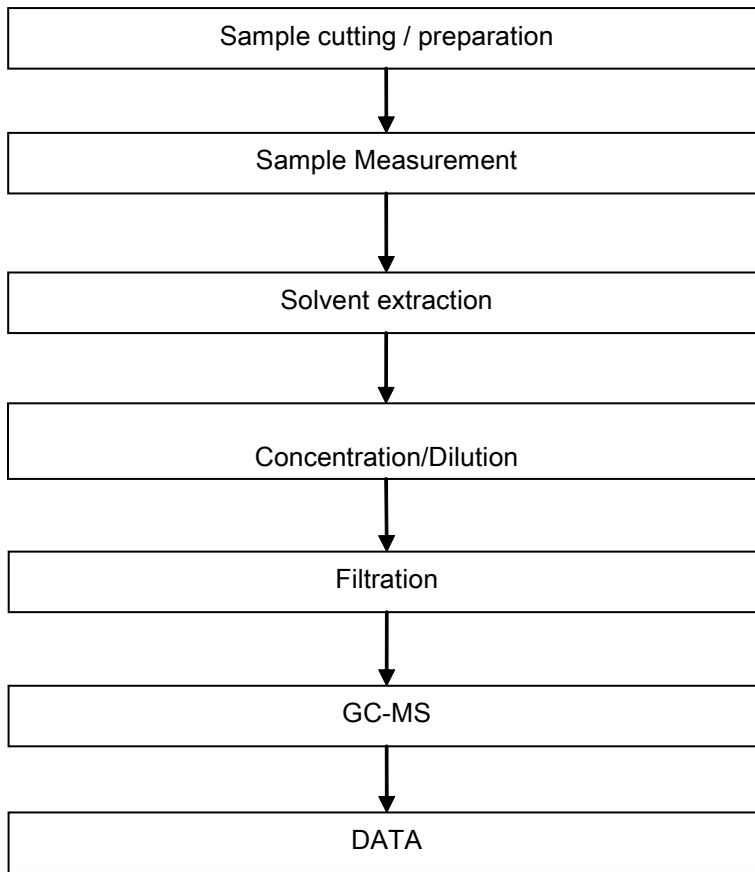

This document is issued by the Company subject to its General Conditions of Service printed overleaf, available on request or accessible at http://www.sgs.com/terms_and_conditions.htm and, for electronic format documents, subject to Terms and Conditions for Electronic Documents at www.sgs.com/terms_e-document.htm. Attention is drawn to the limitation of liability, indemnification and jurisdiction issues defined therein. Any holder of this document is advised that information contained hereon reflects the Company's findings at the time of its preparation only and within the limits of Client's instructions, if any. The Company's sole responsibility is to its Client and this document does not exonerate parties to a transaction from exercising all their rights and obligations under the transaction documents. This document cannot be reproduced except in full, without prior written approval of the Company. Any unauthorized alteration, forgery or falsification of the content or appearance of this document is unlawful and offenders may be prosecuted to the fullest extent of the law. Unless otherwise stated, the results shown in this test report refer only to the sample(s) tested.

ATTACHMENTS

Phthalates Testing Flow Chart

- 1) Name of the person who made testing: Liu Qiong
- 2) Name of the person in charge of testing: Yolanda Wei

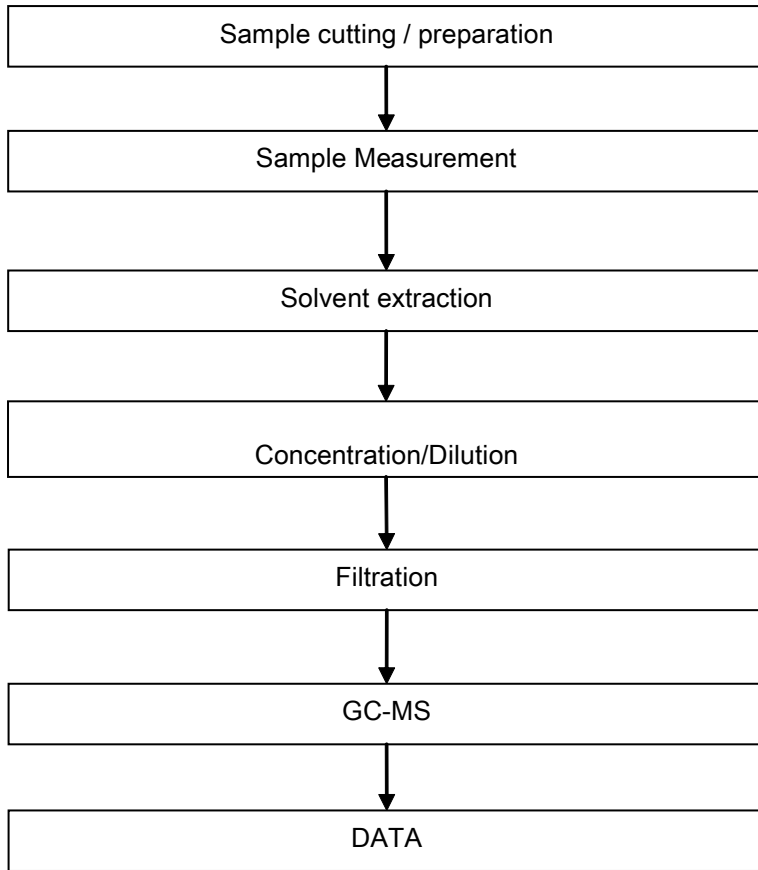

This document is issued by the Company subject to its General Conditions of Service printed overleaf, available on request or accessible at http://www.sgs.com/terms_and_conditions.htm and, for electronic format documents, subject to Terms and Conditions for Electronic Documents at www.sgs.com/terms_e-document.htm. Attention is drawn to the limitation of liability, indemnification and jurisdiction issues defined therein. Any holder of this document is advised that information contained hereon reflects the Company's findings at the time of its preparation only and within the limits of Client's instructions, if any. The Company's sole responsibility is to its Client and this document does not exonerate parties to a transaction from exercising all their rights and obligations under the transaction documents. This document cannot be reproduced except in full, without prior written approval of the Company. Any unauthorized alteration, forgery or falsification of the content or appearance of this document is unlawful and offenders may be prosecuted to the fullest extent of the law. Unless otherwise stated, the results shown in this test report refer only to the sample(s) tested.

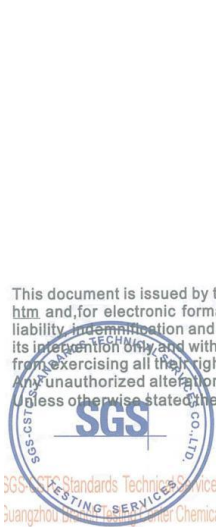

ATTACHMENTS

TBBP-A Testing Flow Chart

- 1) Name of the person who made testing: Cutey Yu
- 2) Name of the person in charge of testing: Yolanda Wei

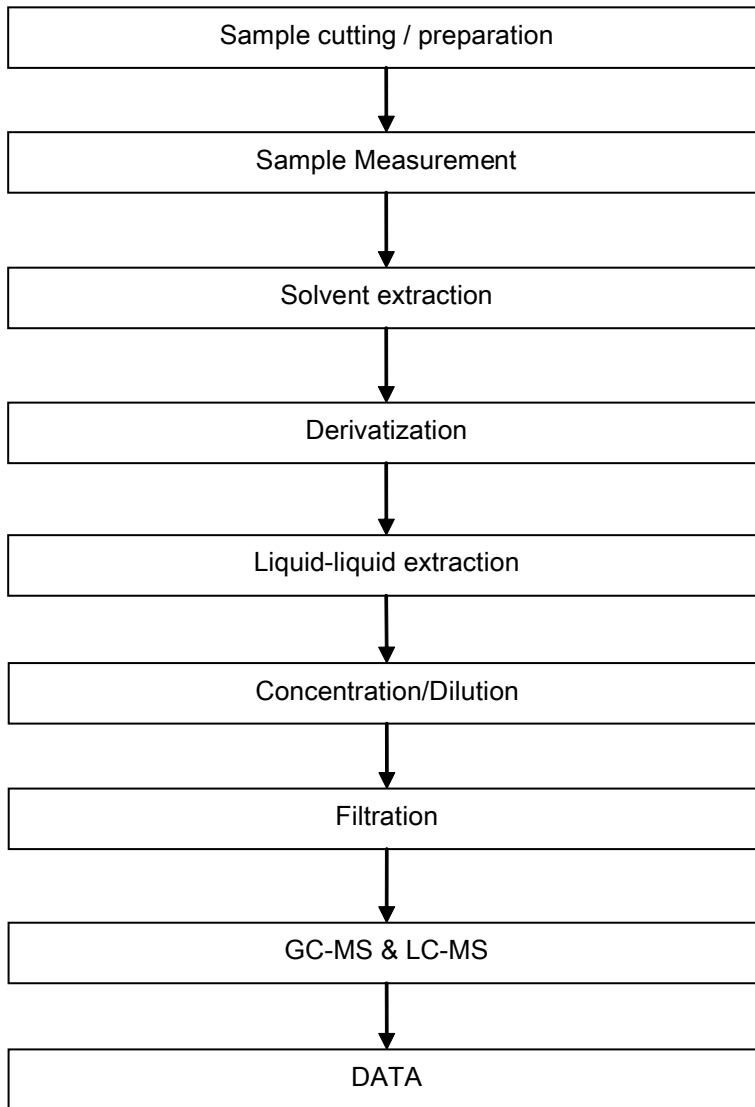

This document is issued by the Company subject to its General Conditions of Service printed overleaf, available on request or accessible at http://www.sgs.com/terms_and_conditions.htm and, for electronic format documents, subject to Terms and Conditions for Electronic Documents at www.sgs.com/terms_e-document.htm. Attention is drawn to the limitation of liability, indemnification and jurisdiction issues defined therein. Any holder of this document is advised that information contained hereon reflects the Company's findings at the time of its preparation only and within the limits of Client's instructions, if any. The Company's sole responsibility is to its Client and this document does not exonerate parties to a transaction from exercising all their rights and obligations under the transaction documents. This document cannot be reproduced except in full, without prior written approval of the Company. Any unauthorized alteration, forgery or falsification of the content or appearance of this document is unlawful and offenders may be prosecuted to the fullest extent of the law. Unless otherwise stated, the results shown in this test report refer only to the sample(s) tested.

ATTACHMENTS

PAHs Testing Flow Chart

- 1) Name of the person who made testing: Cutey Yu
- 2) Name of the person in charge of testing: Yolanda Wei

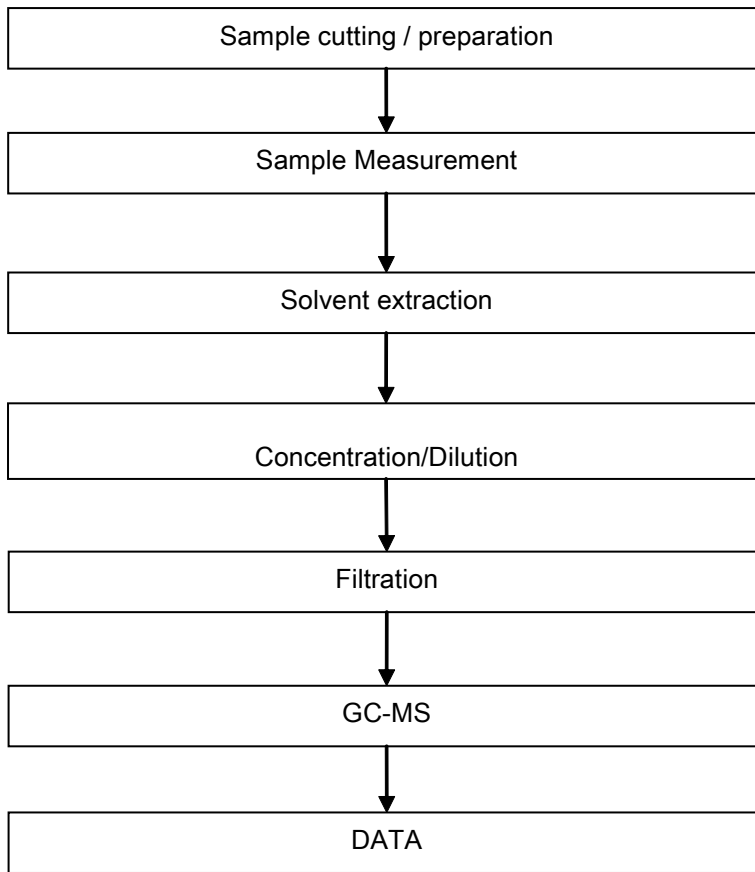

This document is issued by the Company subject to its General Conditions of Service printed overleaf, available on request or accessible at http://www.sgs.com/terms_and_conditions.htm and, for electronic format documents, subject to Terms and Conditions for Electronic Documents at www.sgs.com/terms_e-document.htm. Attention is drawn to the limitation of liability, indemnification and jurisdiction issues defined therein. Any holder of this document is advised that information contained hereon reflects the Company's findings at the time of its preparation only and within the limits of Client's instructions, if any. The Company's sole responsibility is to its Client and this document does not exonerate parties to a transaction from exercising all their rights and obligations under the transaction documents. This document cannot be reproduced except in full, without prior written approval of the Company. Any unauthorized alteration, forgery or falsification of the content or appearance of this document is unlawful and offenders may be prosecuted to the fullest extent of the law. Unless otherwise stated, the results shown in this test report refer only to the sample(s) tested.

ATTACHMENTS

Elementary Testing Flow Chart

- 1) Name of the person who made testing: Bella Wang
- 2) Name of the person in charge of testing: Adams Yu

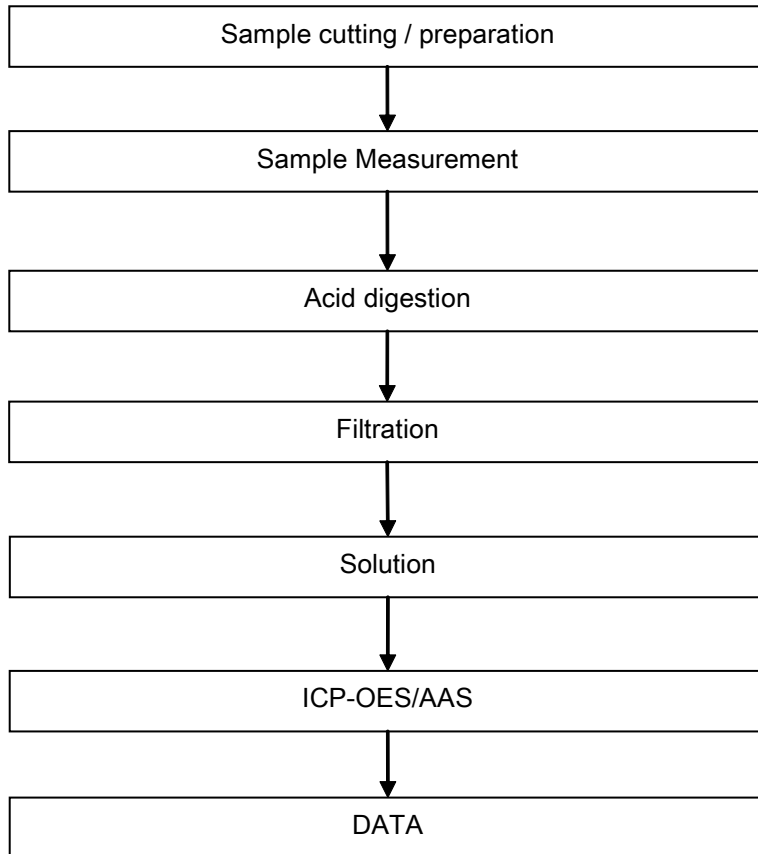

This document is issued by the Company subject to its General Conditions of Service printed overleaf, available on request or accessible at http://www.sgs.com/terms_and_conditions.htm and, for electronic format documents, subject to Terms and Conditions for Electronic Documents at www.sgs.com/terms_e-document.htm. Attention is drawn to the limitation of liability, indemnification and jurisdiction issues defined therein. Any holder of this document is advised that information contained hereon reflects the Company's findings at the time of its preparation only, and within the limits of Client's instructions, if any. The Company's sole responsibility is to its Client and this document does not exonerate parties to a transaction from exercising all their rights and obligations under the transaction documents. This document cannot be reproduced except in full, without prior written approval of the Company. Any unauthorized alteration, forgery or falsification of the content or appearance of this document is unlawful and offenders may be prosecuted to the fullest extent of the law. Unless otherwise stated, the results shown in this test report refer only to the sample(s) tested.

Test Results :

Test Part Description :

Specimen No.	SGS Sample ID	Description
1	CAN13-008615.002	Silvery metal

Remarks :

- (1) 1 mg/kg = 1 ppm = 0.0001%
- (2) MDL = Method Detection Limit
- (3) ND = Not Detected (< MDL)
- (4) "-" = Not Regulated

Elementary Analysis

Test Method : With reference to IEC 62321:2008

- (1) Determination of Cadmium by ICP-OES.
- (2) Determination of Lead by ICP-OES.
- (3) Determination of Mercury by ICP-OES.
- (4) Determination of Hexavalent Chromium by Spot test / Colorimetric Method using UV-Vis.

<u>Test Item(s)</u>	<u>Unit</u>	<u>MDL</u>	<u>002</u>
Cadmium (Cd)	mg/kg	2	ND
Lead (Pb)	mg/kg	2	15
Mercury (Hg)	mg/kg	2	ND
Hexavalent Chromium (CrVI)	-	◇	Negative

Notes :

- (1)◇Spot-test:
Negative = Absence of CrVI coating, Positive = Presence of CrVI coating;
(The tested sample should be further verified by boiling-water-extraction method if the spot test result is Negative or cannot be confirmed.)
- ◇Boiling-water-extraction:
Negative = Absence of CrVI coating
Positive = Presence of CrVI coating; the detected concentration in boiling-water-extraction solution is equal or greater than 0.02 mg/kg with 50 cm² sample surface area.
Information on storage conditions and production date of the tested sample is unavailable and thus results of Cr(VI) represent status of the sample at the time of testing.

Elementary Analysis

This document is issued by the Company subject to its General Conditions of Service printed overleaf, available on request or accessible at http://www.sgs.com/terms_and_conditions.htm and, for electronic format documents, subject to Terms and Conditions for Electronic Documents at www.sgs.com/terms_e-document.htm. Attention is drawn to the limitation of liability, jurisdiction and jurisdiction issues defined therein. Any holder of this document is advised that information contained hereon reflects the Company's findings at the time of its preparation only and within the limits of Client's instructions, if any. The Company's sole responsibility is to its Client and this document does not exonerate parties to a transaction from exercising all their rights and obligations under the transaction documents. This document cannot be reproduced except in full, without prior written approval of the Company. Any unauthorized alteration, forgery or falsification of the content or appearance of this document is unlawful and offenders may be prosecuted to the fullest extent of the law. Unless otherwise stated, the results shown in this test report refer only to the sample(s) tested.

Test Report

No. CANEC1300861502

Date: 23 Jan 2013

Page 3 of 7

Test Method : With reference to US EPA Method 3050B:1996, analysis was performed by ICP-OES.

<u>Test Item(s)</u>	<u>Unit</u>	<u>MDL</u>	<u>002</u>
Arsenic (As)	mg/kg	10	ND

PFOS (Perfluorooctane Sulfonates)

Test Method : With reference to US EPA 3550C: 2007, analysis was performed by HPLC-MS.

<u>Test Item(s)</u>	<u>Unit</u>	<u>MDL</u>	<u>002</u>
Perfluorooctane Sulfonates (PFOS) and related Acid, Metal Salt and Amide	mg/kg	10	ND

Notes :

For reference: commission regulation (EU) No 757/2010 amending regulation (EC) No 850/2004:

- (1) For the purposes of this entry, Article 4(1) (b) shall apply to concentrations of PFOS equal to or below 10 mg/kg (0,001 % by weight) when it occurs in substances or in preparations.
- (2) For the purposes of this entry, Article 4(1) (b) shall apply to concentrations of PFOS in semi-finished products or articles, or parts thereof, if the concentration of PFOS is lower than 0,1 % by weight calculated with reference to the mass of structurally or micro-structurally distinct parts that contain PFOS or, for textiles or other coated materials, if the amount of PFOS is lower than 1µg /m2 of the coated material.

This document is issued by the Company subject to its General Conditions of Service printed overleaf, available on request or accessible at http://www.sgs.com/terms_and_conditions.htm and, for electronic format documents, subject to Terms and Conditions for Electronic Documents at www.sgs.com/terms_e-document.htm. Attention is drawn to the limitation of liability, indemnification and jurisdiction issues defined therein. Any holder of this document is advised that information contained hereon reflects the Company's findings at the time of its preparation only and within the limits of Client's instructions, if any. The Company's sole responsibility is to its Client and this document does not exonerate parties to a transaction from exercising all their rights and obligations under the transaction documents. This document cannot be reproduced except in full, without prior written approval of the Company. Any unauthorized alteration, forgery or falsification of the content or appearance of this document is unlawful and offenders may be prosecuted to the fullest extent of the law. Unless otherwise stated, the results shown in this test report refer only to the sample(s) tested.

ATTACHMENTS

RoHS Testing Flow Chart

- 1) Name of the person who made testing: Michael Tso
- 2) Name of the person in charge of testing: Adams Yu
- 3) These samples were dissolved totally by pre-conditioning method according to below flow chart (Cr6+ test method excluded).

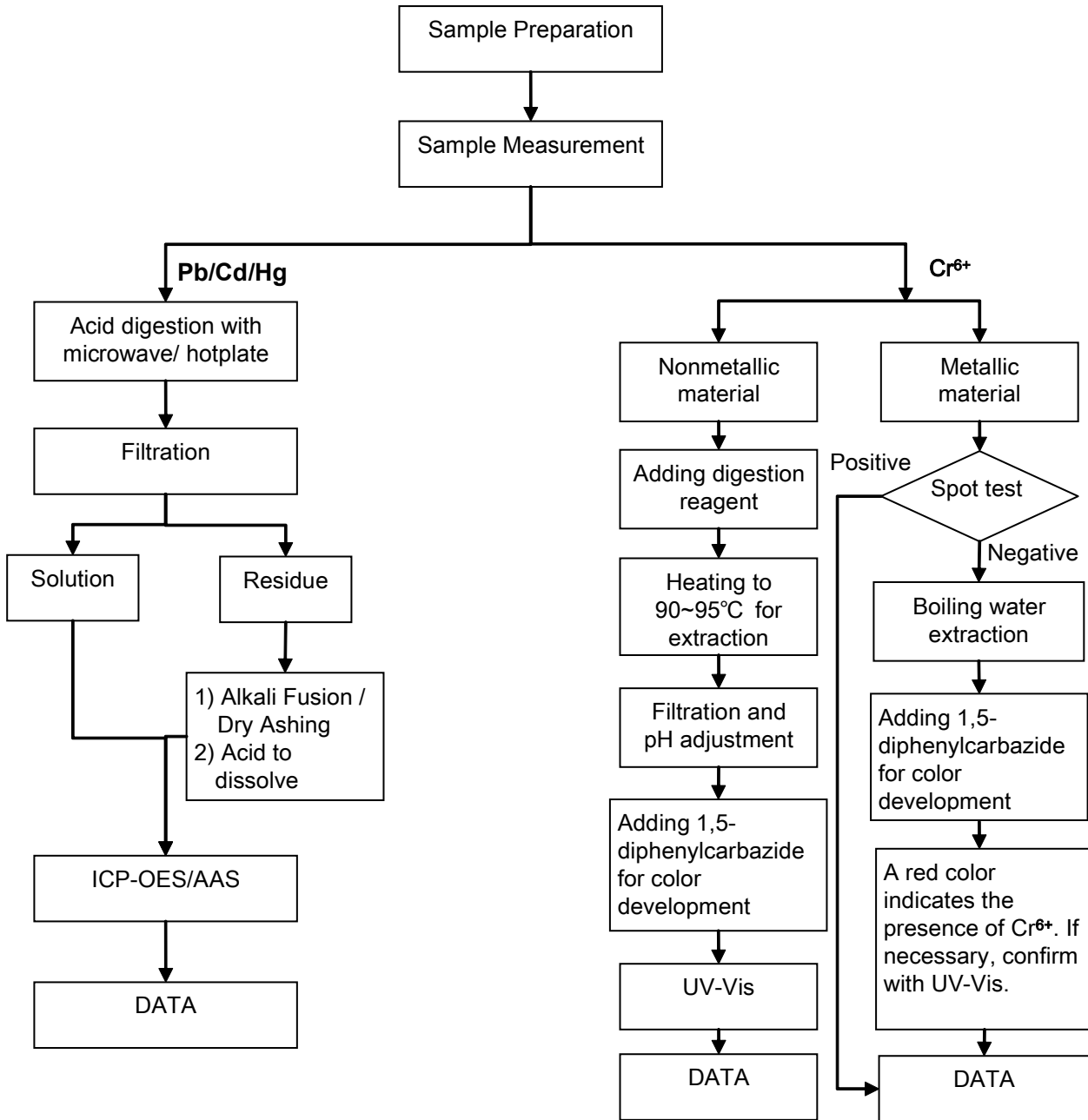

This document is issued by the Company subject to its General Conditions of Service printed overleaf, available on request or accessible at http://www.sgs.com/terms_and_conditions.htm and, for electronic format documents, subject to Terms and Conditions for Electronic Documents at www.sgs.com/terms_e-document.htm. Attention is drawn to the limitation of liability, indemnification and jurisdiction issues defined therein. Any holder of this document is advised that information contained hereon reflects the Company's findings at the time of its preparation only and within the limits of Client's instructions, if any. The Company's sole responsibility is to its Client and this document does not exonerate parties to a transaction from exercising all their rights and obligations under the transaction documents. This document cannot be reproduced except in full, without prior written approval of the Company. Any unauthorized alteration, forgery or falsification of the content or appearance of this document is unlawful and offenders may be prosecuted to the fullest extent of the law. Unless otherwise stated, the results shown in this test report refer only to the sample(s) tested.

ATTACHMENTS

PFOA / PFOS Testing Flow Chart

- 1) Name of the person who made testing: Tina Zhao
- 2) Name of the person in charge of testing: Yolanda Wei

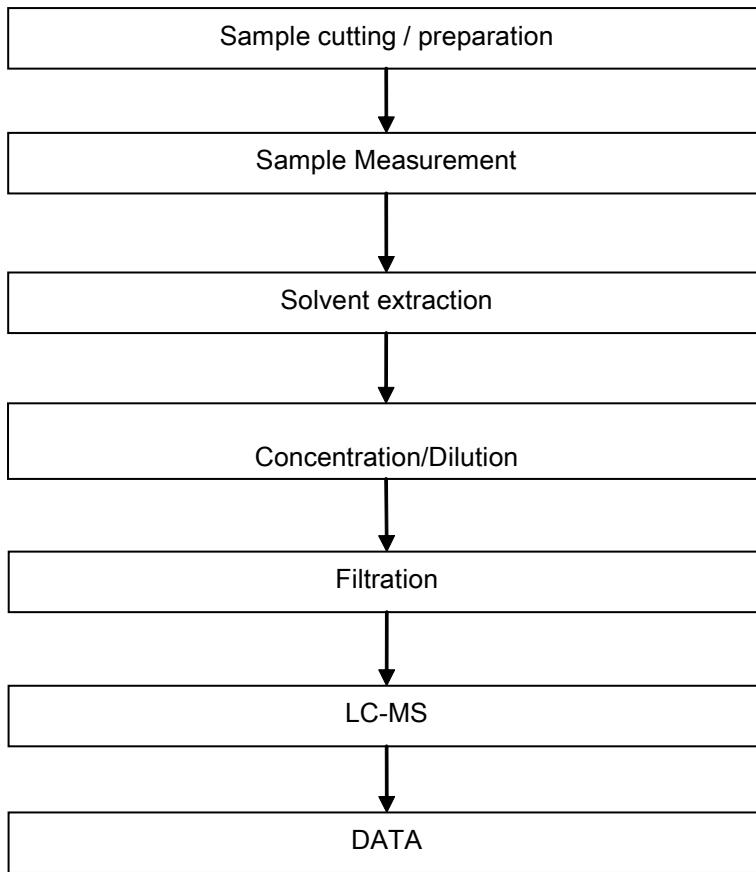

This document is issued by the Company subject to its General Conditions of Service printed overleaf, available on request or accessible at http://www.sgs.com/terms_and_conditions.htm and, for electronic format documents, subject to Terms and Conditions for Electronic Documents at www.sgs.com/terms_e-document.htm. Attention is drawn to the limitation of liability, indemnification and jurisdiction issues defined therein. Any holder of this document is advised that information contained hereon reflects the Company's findings at the time of its preparation only and within the limits of Client's instructions, if any. The Company's sole responsibility is to its Client and this document does not exonerate parties to a transaction from exercising all their rights and obligations under the transaction documents. This document cannot be reproduced except in full, without prior written approval of the Company. Any unauthorized alteration, forgery or falsification of the content or appearance of this document is unlawful and offenders may be prosecuted to the fullest extent of the law. Unless otherwise stated, the results shown in this test report refer only to the sample(s) tested.

ATTACHMENTS

Elementary Testing Flow Chart

- 1) Name of the person who made testing: Bella Wang
- 2) Name of the person in charge of testing: Adams Yu

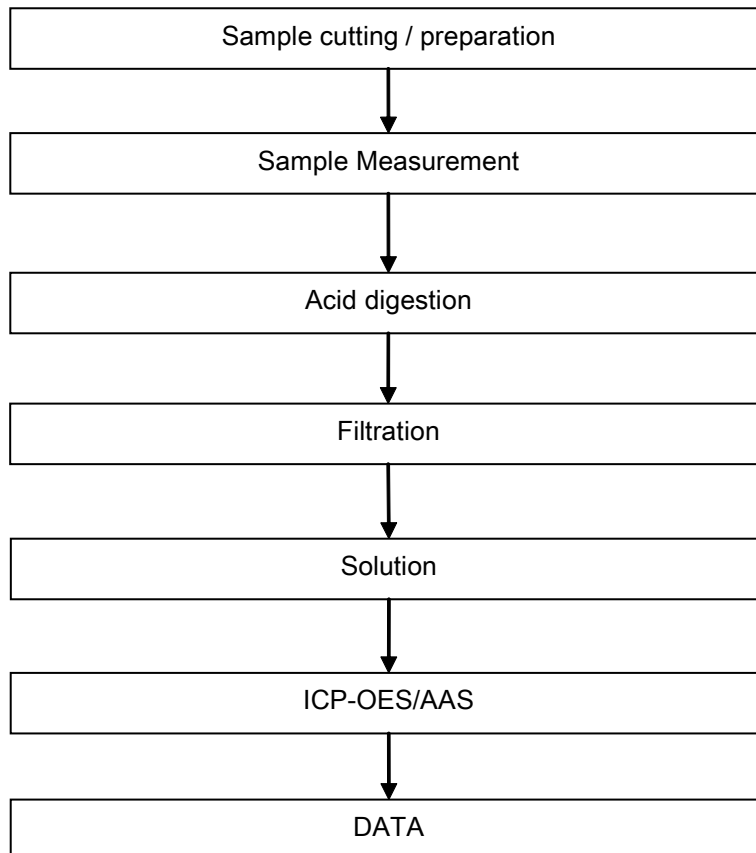

This document is issued by the Company subject to its General Conditions of Service printed overleaf, available on request or accessible at http://www.sgs.com/terms_and_conditions.htm and, for electronic format documents, subject to Terms and Conditions for Electronic Documents at www.sgs.com/terms_e-document.htm. Attention is drawn to the limitation of liability, indemnification and jurisdiction issues defined therein. Any holder of this document is advised that information contained hereon reflects the Company's findings at the time of its preparation only, and within the limits of Client's instructions, if any. The Company's sole responsibility is to its Client and this document does not exonerate parties to a transaction from exercising all their rights and obligations under the transaction documents. This document cannot be reproduced except in full, without prior written approval of the Company. Any unauthorized alteration, forgery or falsification of the content or appearance of this document is unlawful and offenders may be prosecuted to the fullest extent of the law. Unless otherwise stated, the results shown in this test report refer only to the sample(s) tested.

Test Report

No. CANML1215127901

Date: 13 Nov 2012

Page 1 of 5

SHEN ZHEN ZHONGJIAN METAL PRODUCTS CO.,LTD

NO.10,ZAOHEKENG INDUSTRIAL ZONE,JIXIA VILLAGE,BUJI TOWN, LONGGANG DISTRICT, SHENZHEN CITY, GUANGDONG CHINA

The following sample(s) was/were submitted and identified on behalf of the clients as : T2 CU BASE

SGS Job No. : GC121122837 - GZ

Internal Reference No. : 2.1

Date of Sample Received : 08 Nov 2012

Testing Period : 08 Nov 2012 - 13 Nov 2012

Test Requested : Selected test(s) as requested by client.

Test Method : Please refer to next page(s).

Test Results : Please refer to next page(s).

Conclusion : Based on the performed tests on submitted samples, the results of Lead, Mercury, Cadmium, Hexavalent chromium, Polybrominated biphenyls (PBB), Polybrominated diphenyl ethers (PBDE) comply with the limits as set by RoHS Directive 2011/65/EU Annex II; recasting 2002/95/EC.

Signed for and on behalf of
SGS-CSTC Ltd.



Trophy Zhang
Approved Signatory

This document is issued by the Company subject to its General Conditions of Service printed overleaf, available on request or accessible at http://www.sgs.com/terms_and_conditions.htm and, for electronic format documents, subject to Terms and Conditions for Electronic Documents at www.sgs.com/terms_e-document.htm. Attention is drawn to the limitation of liability, indemnification and jurisdiction issues defined therein. Any holder of this document is advised that information contained hereon reflects the Company's findings at the time of its preparation only, and within the limits of Client's instructions, if any. The Company's sole responsibility is to its Client and this document does not exonerate parties to a transaction from exercising all their rights and obligations under the transaction documents. This document cannot be reproduced except in full, without prior written approval of the Company. Any unauthorized alteration, forgery or falsification of the content or appearance of this document is unlawful and offenders may be prosecuted to the fullest extent of the law. Unless otherwise stated, the results shown in this test report refer only to the sample(s) tested.

Test Report

No. CANML1215127901

Date: 13 Nov 2012

Page 2 of 5

Test Results :

Test Part Description :

Specimen No.	SGS Sample ID	Description
1	CAN12-151279.001	Copper-colored metal

Remarks :

- (1) 1 mg/kg = 1 ppm = 0.0001%
- (2) MDL = Method Detection Limit
- (3) ND = Not Detected (< MDL)
- (4) "-" = Not Regulated

RoHS Directive 2011/65/EU

Test Method : With reference to IEC 62321:2008

- (1) Determination of Cadmium by ICP-OES.
- (2) Determination of Lead by ICP-OES.
- (3) Determination of Mercury by ICP-OES.
- (4) Determination of Hexavalent Chromium by Spot test / Colorimetric Method using UV-Vis.
- (5) Determination of PBBs / PBDEs by GC-MS.

Test Item(s)	Limit	Unit	MDL	001
Cadmium (Cd)	100	mg/kg	2	ND
Lead (Pb)	1,000	mg/kg	2	ND
Mercury (Hg)	1,000	mg/kg	2	ND
Hexavalent Chromium (CrVI)	-	-	◇	Negative
Sum of PBBs	1,000	mg/kg	-	ND
Monobromobiphenyl	-	mg/kg	5	ND
Dibromobiphenyl	-	mg/kg	5	ND
Tribromobiphenyl	-	mg/kg	5	ND
Tetrabromobiphenyl	-	mg/kg	5	ND
Pentabromobiphenyl	-	mg/kg	5	ND
Hexabromobiphenyl	-	mg/kg	5	ND
Heptabromobiphenyl	-	mg/kg	5	ND
Octabromobiphenyl	-	mg/kg	5	ND
Nonabromobiphenyl	-	mg/kg	5	ND
Decabromobiphenyl	-	mg/kg	5	ND
Sum of PBDEs	1,000	mg/kg	-	ND
Monobromodiphenyl ether	-	mg/kg	5	ND

This document is issued by the Company subject to its General Conditions of Service printed overleaf, available on request or accessible at http://www.sgs.com/terms_and_conditions.htm and, for electronic format documents, subject to Terms and Conditions for Electronic Documents at www.sgs.com/terms_e-document.htm. Attention is drawn to the limitation of liability, indemnification and jurisdiction issues defined therein. Any holder of this document is advised that information contained hereon reflects the Company's findings at the time of its preparation only and within the limits of Client's instructions, if any. The Company's sole responsibility is to its Client and this document does not exonerate parties to a transaction from exercising all their rights and obligations under the transaction documents. This document cannot be reproduced except in full, without prior written approval of the Company. Any unauthorized alteration, forgery or falsification of the content or appearance of this document is unlawful and offenders may be prosecuted to the fullest extent of the law. Unless otherwise stated, the results shown in this test report refer only to the sample(s) tested.

Test Report

No. CANML1215127901

Date: 13 Nov 2012

Page 3 of 5

<u>Test Item(s)</u>	<u>Limit</u>	<u>Unit</u>	<u>MDL</u>	<u>001</u>
Dibromodiphenyl ether	-	mg/kg	5	ND
Tribromodiphenyl ether	-	mg/kg	5	ND
Tetrabromodiphenyl ether	-	mg/kg	5	ND
Pentabromodiphenyl ether	-	mg/kg	5	ND
Hexabromodiphenyl ether	-	mg/kg	5	ND
Heptabromodiphenyl ether	-	mg/kg	5	ND
Octabromodiphenyl ether	-	mg/kg	5	ND
Nonabromodiphenyl ether	-	mg/kg	5	ND
Decabromodiphenyl ether	-	mg/kg	5	ND

Notes :

(1) The maximum permissible limit is quoted from the directive 2011/65/EU, Annex II

(2)◇Spot-test:

Negative = Absence of CrVI coating, Positive = Presence of CrVI coating;

(The tested sample should be further verified by boiling-water-extraction method if the spot test result is Negative or cannot be confirmed.)

◇Boiling-water-extraction:

Negative = Absence of CrVI coating

Positive = Presence of CrVI coating; the detected concentration in boiling-water-extraction solution is equal or greater than 0.02 mg/kg with 50 cm² sample surface area.

For corrosion protection coatings on metals: Information on storage conditions and production date of the tested sample is unavailable and thus results of Cr(VI) represent status of the sample at the time of testing.

This document is issued by the Company subject to its General Conditions of Service printed overleaf, available on request or accessible at http://www.sgs.com/terms_and_conditions.htm and, for electronic format documents, subject to Terms and Conditions for Electronic Documents at www.sgs.com/terms_e-document.htm. Attention is drawn to the limitation of liability, indemnification and jurisdiction issues defined therein. Any holder of this document is advised that information contained hereon reflects the Company's findings at the time of its preparation only and within the limits of Client's instructions, if any. The Company's sole responsibility is to its Client and this document does not exonerate parties to a transaction from exercising all their rights and obligations under the transaction documents. This document cannot be reproduced except in full, without prior written approval of the Company. Any unauthorized alteration, forgery or falsification of the content or appearance of this document is unlawful and offenders may be prosecuted to the fullest extent of the law. Unless otherwise stated, the results shown in this test report refer only to the sample(s) tested.

ATTACHMENTS

RoHS Testing Flow Chart

- 1) Name of the person who made testing: Michael Tso / Cutey Yu
- 2) Name of the person in charge of testing: Adams Yu / Yolanda Wei
- 3) These samples were dissolved totally by pre-conditioning method according to below flow chart (Cr⁶⁺ and PBBs/PBDEs test method excluded).

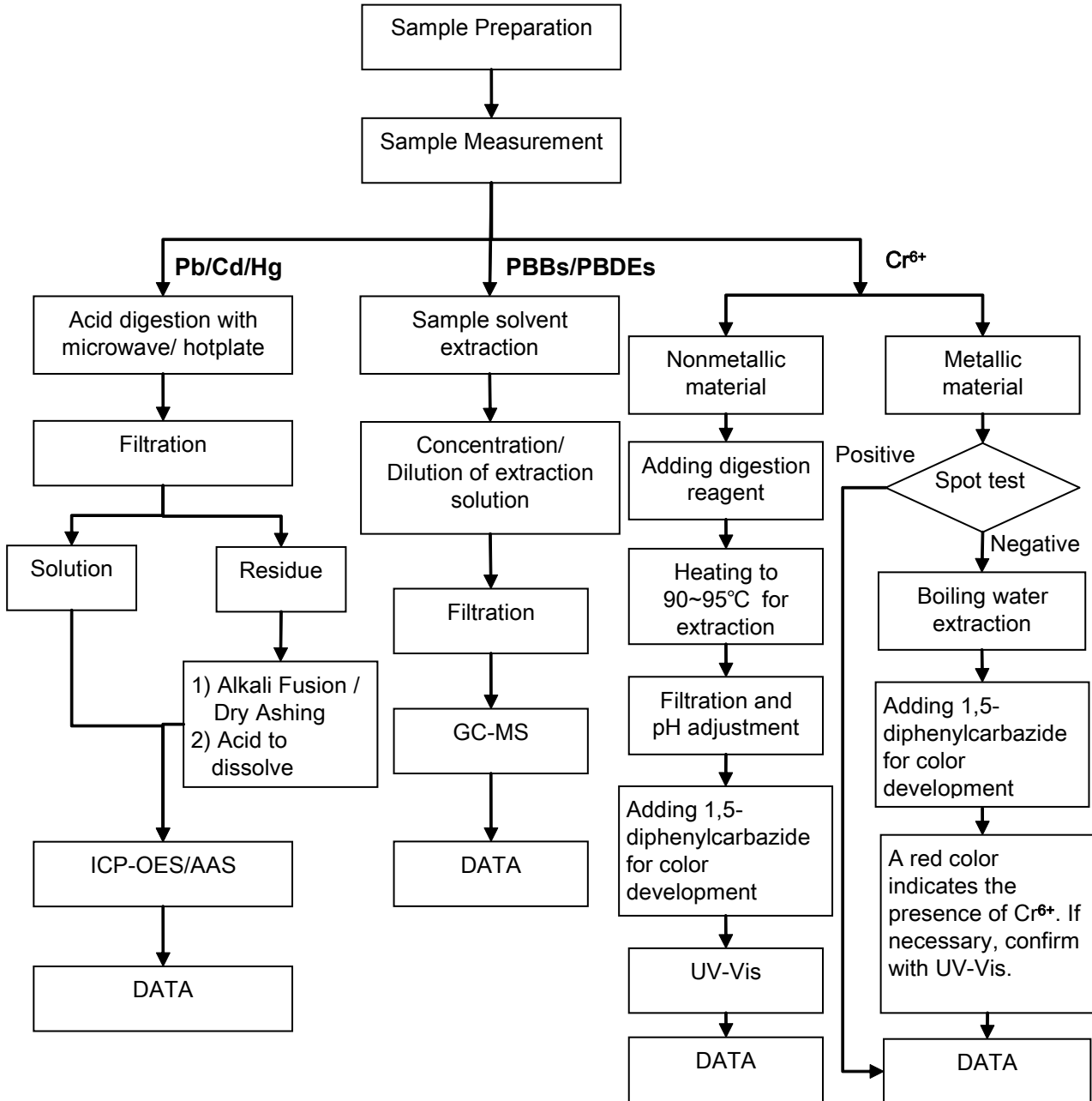

This document is issued by the Company subject to its General Conditions of Service printed overleaf, available on request or accessible at http://www.sgs.com/terms_and_conditions.htm and, for electronic format documents, subject to Terms and Conditions for Electronic Documents at www.sgs.com/terms_e-document.htm. Attention is drawn to the limitation of liability, indemnification and jurisdiction issues defined therein. Any holder of this document is advised that information contained hereon reflects the Company's findings at the time of its preparation only and within the limits of Client's instructions, if any. The Company's sole responsibility is to its Client and this document does not exonerate parties to a transaction from exercising all their rights and obligations under the transaction documents. This document cannot be reproduced except in full, without prior written approval of the Company. Any unauthorized alteration, forgery or falsification of the content or appearance of this document is unlawful and offenders may be prosecuted to the fullest extent of the law. Unless otherwise stated, the results shown in this test report refer only to the sample(s) tested.

測試報告 Test Report

號碼(No.) : KA/2013/61204 日期(Date) : 2013/07/04 頁數(Page) : 1 of 12

安天德百電股份有限公司
ITW ELECTRONIC BUSINESS ASIA CO., LTD.
高雄市前鎮加工出口區東六街3-2號
A4, 3-2, K.E.P.Z. KAOHSIUNG, TAIWAN

以下測試樣品係由客戶送樣，且由客戶聲稱並經客戶確認如下 (The following samples was/were submitted and identified by/on behalf of the client as):

樣品名稱(Sample Description)	:	3999-00-5550
樣品型號(Style/Item No.)	:	FASTENER CAP
材質(Material)	:	PC+20%GF
收件日期(Sample Receiving Date)	:	2013/06/28
測試期間(Testing Period)	:	2013/06/28 TO 2013/07/04
送樣廠商(Sample Submitted By)	:	安天德百電股份有限公司 (ITW ELECTRONIC BUSINESS ASIA CO., LTD.)

=====
測試結果(Test Results) : 請見下一頁 (Please refer to next pages).

Ray Chang / Asst. Manager
Signed for and on behalf of
SGS Taiwan Limited



測試報告

Test Report

號碼(No.) : KA/2013/61204 日期(Date) : 2013/07/04 頁數(Page) : 2 of 12

安天德百電股份有限公司
ITW ELECTRONIC BUSINESS ASIA CO., LTD.
高雄市前鎮加工出口區東六街3-2號
A4, 3-2, K.E.P.Z. KAOHSIUNG, TAIWAN

測試結果(Test Results)

測試部位(PART NAME) NO.1 : (BLACK 3999-00-5550)

測試項目 (Test Items)	單位 (Unit)	測試方法 (Method)	方法偵測 極限值 (MDL)	結果 (Result)
				NO.1
鎘 / Cadmium (Cd)	mg/kg	參考IEC 62321: 2008方法, 用感應耦合電漿原子發射光譜儀檢測. / With reference to IEC 62321: 2008 and performed by ICP-AES.	2	n.d.
鉛 / Lead (Pb)	mg/kg	參考IEC 62321: 2008方法, 用感應耦合電漿原子發射光譜儀檢測. / With reference to IEC 62321: 2008 and performed by ICP-AES.	2	6.11
汞 / Mercury (Hg)	mg/kg	參考IEC 62321: 2008方法, 用感應耦合電漿原子發射光譜儀檢測. / With reference to IEC 62321: 2008 and performed by ICP-AES.	2	n.d.
六價鉻 / Hexavalent Chromium Cr(VI) by alkaline extraction	mg/kg	參考IEC 62321: 2008方法, 用UV-VIS檢測. / With reference to IEC 62321: 2008 and performed by UV-VIS.	2	n.d.
全氟辛烷磺酸 / Perfluorooctane sulfonates (PFOS - Acid, Metal Salt, Amide)	mg/kg	參考US EPA 3550C: 2007方法, 以液相層析/質譜儀檢測. / With reference to US EPA 3550C: 2007. Analysis was performed by LC/MS.	10	n.d.
全氟辛酸(銨) / PFOA (CAS No.: 335-67-1)	mg/kg	參考US EPA 3550C: 2007方法, 以液相層析/質譜儀檢測. / With reference to US EPA 3550C: 2007. Analysis was performed by LC/MS.	10	n.d.

Unless otherwise stated the results shown in this test report refer only to the sample(s) tested. This test report cannot be reproduced, except in full, without prior written permission of the Company. 除非另有說明, 此報告結果僅對測試之樣品負責。本報告未經本公司書面許可, 不可部分複製。
This document is issued by the Company subject to its General Conditions of Service printed overleaf, available on request or accessible at www.sgs.com/terms_and_conditions.htm and, for electronic format documents, subject to Terms and Conditions for Electronic Documents at www.sgs.com/terms_e-document.htm. Attention is drawn to the limitation of liability, indemnification and jurisdiction issues defined therein. Any holder of this document is advised that information contained hereon reflects the Company's findings at the time of its intervention only and within the limits of Client's instructions, if any. The Company's sole responsibility is to its Client and this document does not exonerate parties to a transaction from exercising all their rights and obligations under the transaction documents. This document cannot be reproduced except in full, without prior written approval of the Company. Any unauthorized alteration, forgery or falsification of the content or appearance of this document is unlawful and offenders may be prosecuted to the fullest extent of the law.

測試報告

Test Report

號碼(No.) : KA/2013/61204 日期(Date) : 2013/07/04 頁數(Page) : 3 of 12

安天德百電股份有限公司
ITW ELECTRONIC BUSINESS ASIA CO., LTD.
高雄市前鎮加工出口區東六街3-2號
A4, 3-2, K.E.P.Z. KAOHSIUNG, TAIWAN

測試項目 (Test Items)	單位 (Unit)	測試方法 (Method)	方法偵測 極限值 (MDL)	結果 (Result)
				NO.1
多溴聯苯總和 / Sum of PBBs	mg/kg	參考IEC 62321: 2008方法, 以氣相層析儀/質譜儀檢測. / With reference to IEC 62321: 2008 and performed by GC/MS.	-	n.d.
一溴聯苯 / Monobromobiphenyl			5	n.d.
二溴聯苯 / Dibromobiphenyl			5	n.d.
三溴聯苯 / Tribromobiphenyl			5	n.d.
四溴聯苯 / Tetrabromobiphenyl			5	n.d.
五溴聯苯 / Pentabromobiphenyl			5	n.d.
六溴聯苯 / Hexabromobiphenyl			5	n.d.
七溴聯苯 / Heptabromobiphenyl			5	n.d.
八溴聯苯 / Octabromobiphenyl			5	n.d.
九溴聯苯 / Nonabromobiphenyl			5	n.d.
十溴聯苯 / Decabromobiphenyl	5	n.d.		
多溴聯苯醚總和 / Sum of PBDEs	mg/kg	參考IEC 62321: 2008方法, 以氣相層析儀/質譜儀檢測. / With reference to IEC 62321: 2008 and performed by GC/MS.	-	n.d.
一溴聯苯醚 / Monobromodiphenyl ether			5	n.d.
二溴聯苯醚 / Dibromodiphenyl ether			5	n.d.
三溴聯苯醚 / Tribromodiphenyl ether			5	n.d.
四溴聯苯醚 / Tetrabromodiphenyl ether			5	n.d.
五溴聯苯醚 / Pentabromodiphenyl ether			5	n.d.
六溴聯苯醚 / Hexabromodiphenyl ether			5	n.d.
七溴聯苯醚 / Heptabromodiphenyl ether			5	n.d.
八溴聯苯醚 / Octabromodiphenyl ether			5	n.d.
九溴聯苯醚 / Nonabromodiphenyl ether			5	n.d.
十溴聯苯醚 / Decabromodiphenyl ether	5	n.d.		
鹵素 (溴) / Halogen-Bromine (Br) (CAS No.: 010097-32-2)	mg/kg	參考BS EN 14582:2007, 以離子層析儀分析. / With reference to BS EN 14582:2007. Analysis was performed by IC.	50	n.d.
鹵素 (氯) / Halogen-Chlorine (Cl) (CAS No.: 022537-15-1)	mg/kg	參考BS EN 14582:2007, 以離子層析儀分析. / With reference to BS EN 14582:2007. Analysis was performed by IC.	50	n.d.

Unless otherwise stated the results shown in this test report refer only to the sample(s) tested. This test report cannot be reproduced, except in full, without prior written permission of the Company. 除非另有說明, 此報告結果僅對測試之樣品負責。本報告未經本公司書面許可, 不可部分複製。
This document is issued by the Company subject to its General Conditions of Service printed overleaf, available on request or accessible at www.sgs.com/terms_and_conditions.htm and, for electronic format documents, subject to Terms and Conditions for Electronic Documents at www.sgs.com/terms_e-document.htm. Attention is drawn to the limitation of liability, indemnification and jurisdiction issues defined therein. Any holder of this document is advised that information contained hereon reflects the Company's findings at the time of its intervention only and within the limits of Client's instructions, if any. The Company's sole responsibility is to its Client and this document does not exonerate parties to a transaction from exercising all their rights and obligations under the transaction documents. This document cannot be reproduced except in full, without prior written approval of the Company. Any unauthorized alteration, forgery or falsification of the content or appearance of this document is unlawful and offenders may be prosecuted to the fullest extent of the law.

測試報告

Test Report

號碼(No.) : KA/2013/61204 日期(Date) : 2013/07/04 頁數(Page) : 4 of 12

安天德百電股份有限公司
ITW ELECTRONIC BUSINESS ASIA CO., LTD.
高雄市前鎮加工出口區東六街3-2號
A4, 3-2, K.E.P.Z. KAOHSIUNG, TAIWAN

測試項目 (Test Items)	單位 (Unit)	測試方法 (Method)	方法偵測 極限值 (MDL)	結果 (Result)
				NO.1
可塑劑定量分析 / Phthalates				
鄰苯二甲酸甲苯基丁酯 / BBP (Benzyl butyl phthalate) (CAS No.: 000085-68-7)	%	參考EN 14372, 以氣相層析儀/質譜儀檢測之。 / With reference to EN 14372. Analysis was performed by GC/MS.	0.003	n.d.
鄰苯二甲酸二丁酯 / DBP (Dibutyl phthalate) (CAS No.: 000084-74-2)	%	參考EN 14372, 以氣相層析儀/質譜儀檢測之。 / With reference to EN 14372. Analysis was performed by GC/MS.	0.003	n.d.
鄰苯二甲酸二(2-乙基己基)酯 / DEHP (Di-(2-ethylhexyl) phthalate) (CAS No.: 000117-81-7)	%	參考EN 14372, 以氣相層析儀/質譜儀檢測之。 / With reference to EN 14372. Analysis was performed by GC/MS.	0.003	n.d.
鄰苯二甲酸二異癸酯 / DIDP (Di-isodecyl phthalate) (CAS No.: 026761-40-0)	%	參考EN 14372, 以氣相層析儀/質譜儀檢測之。 / With reference to EN 14372. Analysis was performed by GC/MS.	0.01	n.d.
鄰苯二甲酸二異壬酯 / DINP (Di-isononyl phthalate) (CAS No.: 028553-12-0)	%	參考EN 14372, 以氣相層析儀/質譜儀檢測之。 / With reference to EN 14372. Analysis was performed by GC/MS.	0.01	n.d.
鄰苯二甲酸二正辛酯 / DNOP (Di-n-octyl phthalate) (CAS No.: 000117-84-0)	%	參考EN 14372, 以氣相層析儀/質譜儀檢測之。 / With reference to EN 14372. Analysis was performed by GC/MS.	0.003	n.d.
六溴環十二烷及所有主要被辨別出的異構物 / Hexabromocyclododecane (HBCDD) and all major diastereoisomers identified (α -HBCDD, β -HBCDD, γ -HBCDD) (CAS No.: 25637-99-4 and 3194-55-6 (134237-51-7, 134237-50-6, 134237-52-8))	mg/kg	參考US EPA 3540C: 1996方法, 以氣相層析質譜儀檢測。 / With reference to US EPA 3540C: 1996 method. Analysis was performed by GC/MS.	5	n.d.

Unless otherwise stated the results shown in this test report refer only to the sample(s) tested. This test report cannot be reproduced, except in full, without prior written permission of the Company. 除非另有說明, 此報告結果僅對測試之樣品負責。本報告未經本公司書面許可, 不可部分複製。
This document is issued by the Company subject to its General Conditions of Service printed overleaf, available on request or accessible at www.sgs.com/terms_and_conditions.htm and, for electronic format documents, subject to Terms and Conditions for Electronic Documents at www.sgs.com/terms_e-document.htm. Attention is drawn to the limitation of liability, indemnification and jurisdiction issues defined therein. Any holder of this document is advised that information contained hereon reflects the Company's findings at the time of its intervention only and within the limits of Client's instructions, if any. The Company's sole responsibility is to its Client and this document does not exonerate parties to a transaction from exercising all their rights and obligations under the transaction documents. This document cannot be reproduced except in full, without prior written approval of the Company. Any unauthorized alteration, forgery or falsification of the content or appearance of this document is unlawful and offenders may be prosecuted to the fullest extent of the law.

測試報告

Test Report

號碼(No.) : KA/2013/61204 日期(Date) : 2013/07/04 頁數(Page) : 5 of 12

安天德百電股份有限公司
ITW ELECTRONIC BUSINESS ASIA CO., LTD.
高雄市前鎮加工出口區東六街3-2號
A4, 3-2, K.E.P.Z. KAOHSIUNG, TAIWAN

備註(Note) :

1. mg/kg = ppm ; 0.1wt% = 1000ppm
2. n.d. = Not Detected (未檢出)
3. MDL = Method Detection Limit (方法偵測極限值)
4. "-" = Not Regulated (無規格值)

PFOS參考資訊(Reference Information) : 持久性有機污染物 POPs - (EU) 757/2010

PFOS濃度在物質或製備中不得超過0.001%(10ppm)，在半成品、成品或零部件中不得超過0.1%(1000ppm)，在紡織品或塗層材料中不得超過 $1\mu\text{g}/\text{m}^2$ 。(Outlawing PFOS as substances or preparations in concentrations above 0.001% (10ppm), in semi-finished products or articles or parts at a level above 0.1%(1000ppm), in textiles or other coated materials above $1\mu\text{g}/\text{m}^2$.)

Unless otherwise stated the results shown in this test report refer only to the sample(s) tested. This test report cannot be reproduced, except in full, without prior written permission of the Company. 除非另有說明，此報告結果僅對測試之樣品負責。本報告未經本公司書面許可，不可部分複製。
This document is issued by the Company subject to its General Conditions of Service printed overleaf, available on request or accessible at www.sgs.com/terms_and_conditions.htm and, for electronic format documents, subject to Terms and Conditions for Electronic Documents at www.sgs.com/terms_e-document.htm. Attention is drawn to the limitation of liability, indemnification and jurisdiction issues defined therein. Any holder of this document is advised that information contained hereon reflects the Company's findings at the time of its intervention only and within the limits of Client's instructions, if any. The Company's sole responsibility is to its Client and this document does not exonerate parties to a transaction from exercising all their rights and obligations under the transaction documents. This document cannot be reproduced except in full, without prior written approval of the Company. Any unauthorized alteration, forgery or falsification of the content or appearance of this document is unlawful and offenders may be prosecuted to the fullest extent of the law.

測試報告 Test Report

號碼(No.) : KA/2013/61204 日期(Date) : 2013/07/04 頁數(Page) : 6 of 12

安天德百電股份有限公司
ITW ELECTRONIC BUSINESS ASIA CO., LTD.
高雄市前鎮加工出口區東六街3-2號
A4, 3-2, K.E.P.Z. KAOHSIUNG, TAIWAN

- 1) 根據以下的流程圖之條件，樣品已完全溶解。(六價鉻測試方法除外) / These samples were dissolved totally by pre-conditioning method according to below flow chart. (Cr⁶⁺ test method excluded)
- 2) 測試人員：張俊雄 / Name of the person who made measurement: Alex Chang
- 3) 測試負責人：張伯睿 / Name of the person in charge of measurement: Ray Chang

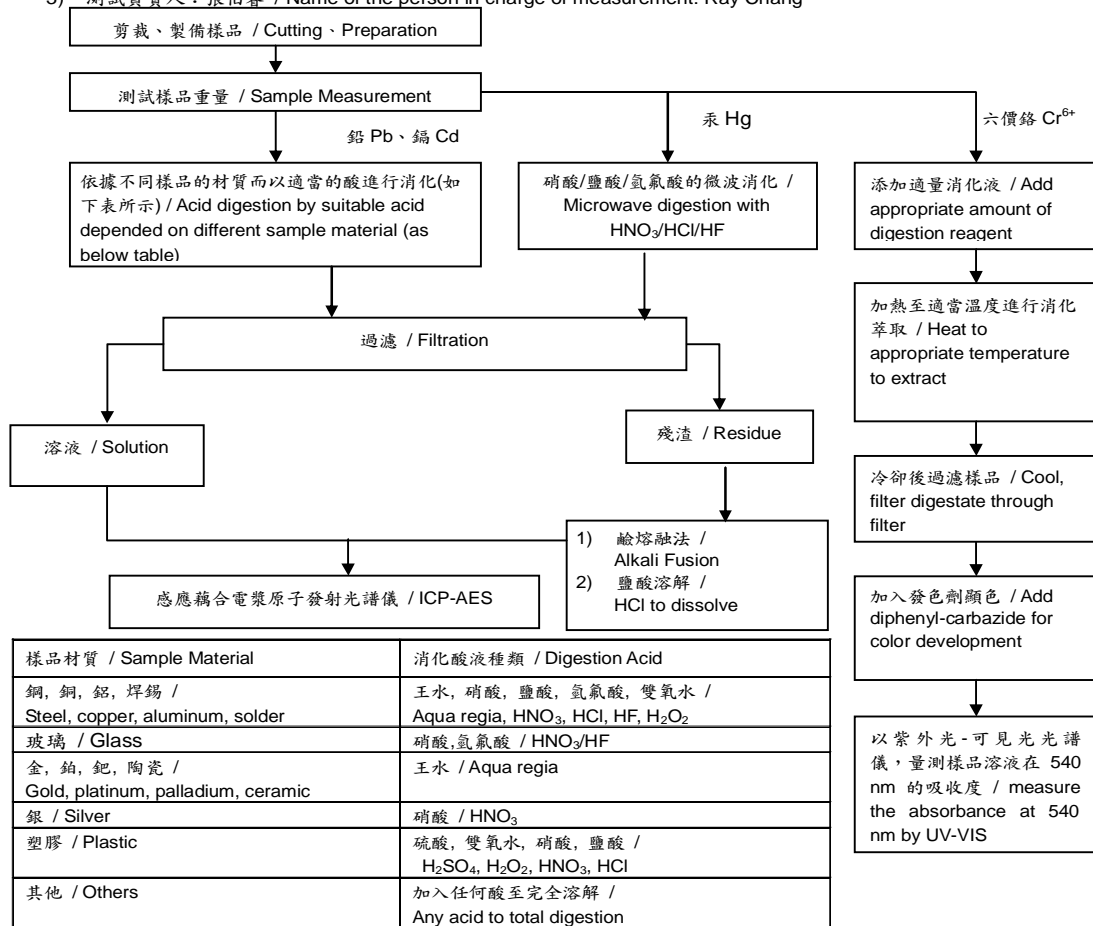

- Note**:** (1) 針對非金屬材料加入鹼性消化液，加熱至 90~95℃ 萃取。 / For non-metallic material, add alkaline digestion reagent and heat to 90~95 °C.
(2) 針對金屬材料加入純水，加熱至沸騰萃取。 / For metallic material, add pure water and heat to boiling.

Unless otherwise stated the results shown in this test report refer only to the sample(s) tested. This test report cannot be reproduced, except in full, without prior written permission of the Company. 除非另有說明，此報告結果僅對測試之樣品負責。本報告未經本公司書面許可，不可部分複製。
This document is issued by the Company subject to its General Conditions of Service printed overleaf, available on request or accessible at www.sgs.com/terms_and_conditions.htm and, for electronic format documents, subject to Terms and Conditions for Electronic Documents at www.sgs.com/terms_e-document.htm. Attention is drawn to the limitation of liability, indemnification and jurisdiction issues defined therein. Any holder of this document is advised that information contained hereon reflects the Company's findings at the time of its intervention only and within the limits of Client's instructions, if any. The Company's sole responsibility is to its Client and this document does not exonerate parties to a transaction from exercising all their rights and obligations under the transaction documents. This document cannot be reproduced except in full, without prior written approval of the Company. Any unauthorized alteration, forgery or falsification of the content or appearance of this document is unlawful and offenders may be prosecuted to the fullest extent of the law.

測試報告 Test Report

號碼(No.) : KA/2013/61204 日期(Date) : 2013/07/04 頁數(Page) : 7 of 12

安天德百電股份有限公司
ITW ELECTRONIC BUSINESS ASIA CO., LTD.
高雄市前鎮加工出口區東六街3-2號
A4, 3-2, K.E.P.Z. KAOHSIUNG, TAIWAN

多溴聯苯/多溴聯苯醚 分析流程圖 / PBB/PBDE analytical FLOW CHART

- 1) 測試人員：曹嘉琪 / Name of the person who made measurement: Anson Tsao
2) 測試負責人：張伯睿 / Name of the person in charge of measurement: Ray Chang

初次測試程序 / First testing process ———▶

選擇性篩檢程序 / Optional screen process▶

確認程序 / Confirmation process - - - ▶

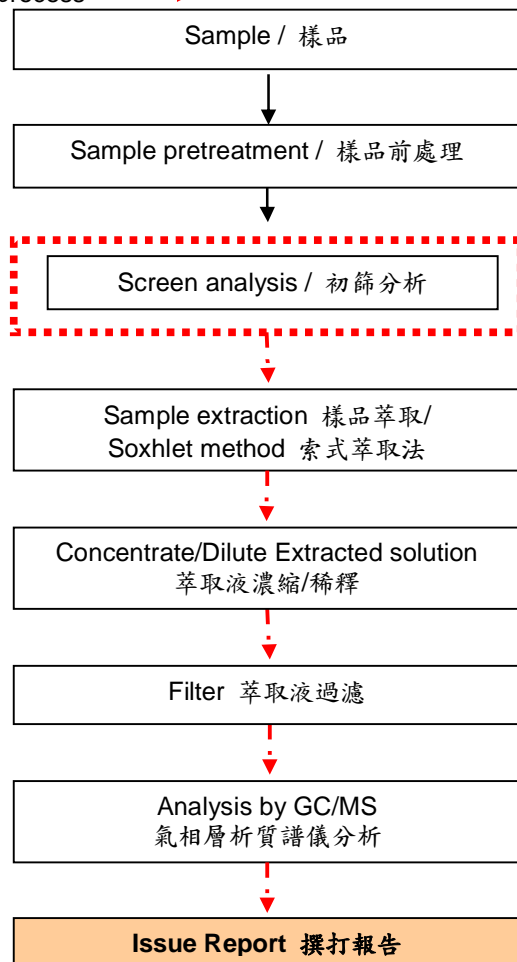

Unless otherwise stated the results shown in this test report refer only to the sample(s) tested. This test report cannot be reproduced, except in full, without prior written permission of the Company. 除非另有說明，此報告結果僅對測試之樣品負責。本報告未經本公司書面許可，不可部分複製。
This document is issued by the Company subject to its General Conditions of Service printed overleaf, available on request or accessible at www.sgs.com/terms_and_conditions.htm and, for electronic format documents, subject to Terms and Conditions for Electronic Documents at www.sgs.com/terms_e-document.htm. Attention is drawn to the limitation of liability, indemnification and jurisdiction issues defined therein. Any holder of this document is advised that information contained hereon reflects the Company's findings at the time of its intervention only and within the limits of Client's instructions, if any. The Company's sole responsibility is to its Client and this document does not exonerate parties to a transaction from exercising all their rights and obligations under the transaction documents. This document cannot be reproduced except in full, without prior written approval of the Company. Any unauthorized alteration, forgery or falsification of the content or appearance of this document is unlawful and offenders may be prosecuted to the fullest extent of the law.

測試報告

Test Report

號碼(No.) : KA/2013/61204 日期(Date) : 2013/07/04 頁數(Page) : 8 of 12

安天德百電股份有限公司
 ITW ELECTRONIC BUSINESS ASIA CO., LTD.
 高雄市前鎮加工出口區東六街3-2號
 A4, 3-2, K.E.P.Z. KAOHSIUNG, TAIWAN

全氟辛酸(銨)/ 全氟辛烷磺酸分析流程圖 /

Analytical flow chart of PFOA/PFOS content

1) 測試人員 : 曹嘉琪 / Name of the person who made measurement: Anson Tsao

2) 測試負責人 : 張伯睿 / Name of the person in charge of measurement: Ray Chang

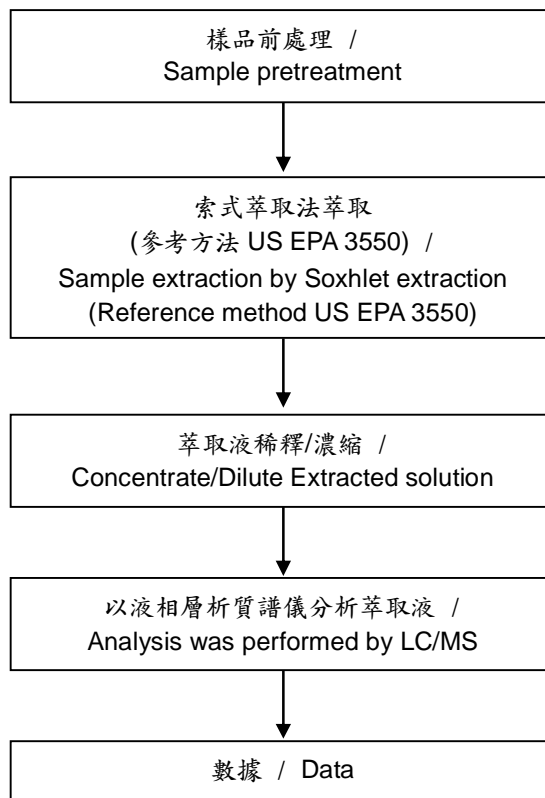

Unless otherwise stated the results shown in this test report refer only to the sample(s) tested. This test report cannot be reproduced, except in full, without prior written permission of the Company. 除非另有說明，此報告結果僅對測試之樣品負責。本報告未經本公司書面許可，不可部分複製。
 This document is issued by the Company subject to its General Conditions of Service printed overleaf, available on request or accessible at www.sgs.com/terms_and_conditions.htm and, for electronic format documents, subject to Terms and Conditions for Electronic Documents at www.sgs.com/terms_e-document.htm. Attention is drawn to the limitation of liability, indemnification and jurisdiction issues defined therein. Any holder of this document is advised that information contained hereon reflects the Company's findings at the time of its intervention only and within the limits of Client's instructions, if any. The Company's sole responsibility is to its Client and this document does not exonerate parties to a transaction from exercising all their rights and obligations under the transaction documents. This document cannot be reproduced except in full, without prior written approval of the Company. Any unauthorized alteration, forgery or falsification of the content or appearance of this document is unlawful and offenders may be prosecuted to the fullest extent of the law.

測試報告

Test Report

號碼(No.) : KA/2013/61204 日期(Date) : 2013/07/04 頁數(Page) : 9 of 12

安天德百電股份有限公司
 ITW ELECTRONIC BUSINESS ASIA CO., LTD.
 高雄市前鎮加工出口區東六街3-2號
 A4, 3-2, K.E.P.Z. KAOHSIUNG, TAIWAN

鹵素分析流程圖 / Analytical flow chart of halogen content

- 1) 測試人員：洪秀真 / Name of the person who made measurement: Jean Hung
- 2) 測試負責人：張伯睿 / Name of the person in charge of measurement: Ray Chang

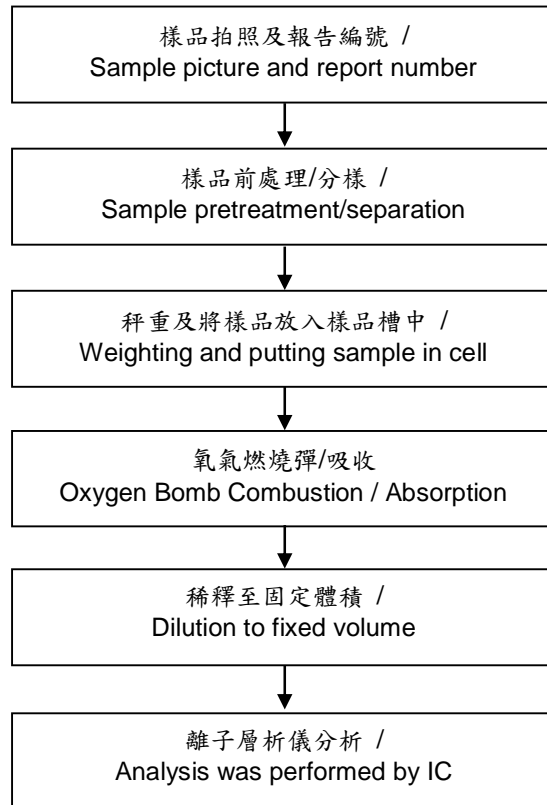

Unless otherwise stated the results shown in this test report refer only to the sample(s) tested. This test report cannot be reproduced, except in full, without prior written permission of the Company. 除非另有說明，此報告結果僅對測試之樣品負責。本報告未經本公司書面許可，不可部分複製。
 This document is issued by the Company subject to its General Conditions of Service printed overleaf, available on request or accessible at www.sgs.com/terms_and_conditions.htm and, for electronic format documents, subject to Terms and Conditions for Electronic Documents at www.sgs.com/terms_e-document.htm. Attention is drawn to the limitation of liability, indemnification and jurisdiction issues defined therein. Any holder of this document is advised that information contained hereon reflects the Company's findings at the time of its intervention only and within the limits of Client's instructions, if any. The Company's sole responsibility is to its Client and this document does not exonerate parties to a transaction from exercising all their rights and obligations under the transaction documents. This document cannot be reproduced except in full, without prior written approval of the Company. Any unauthorized alteration, forgery or falsification of the content or appearance of this document is unlawful and offenders may be prosecuted to the fullest extent of the law.

測試報告 Test Report

號碼(No.) : KA/2013/61204 日期(Date) : 2013/07/04 頁數(Page) : 10 of 12

安天德百電股份有限公司
ITW ELECTRONIC BUSINESS ASIA CO., LTD.
高雄市前鎮加工出口區東六街3-2號
A4, 3-2, K.E.P.Z. KAOHSIUNG, TAIWAN

可塑劑分析流程圖 / Analytical flow chart of phthalate content

- 1) 測試人員：曹嘉琪 / Name of the person who made measurement: Anson Tsao
2) 測試負責人：張伯睿 / Name of the person in charge of measurement: Ray Chang

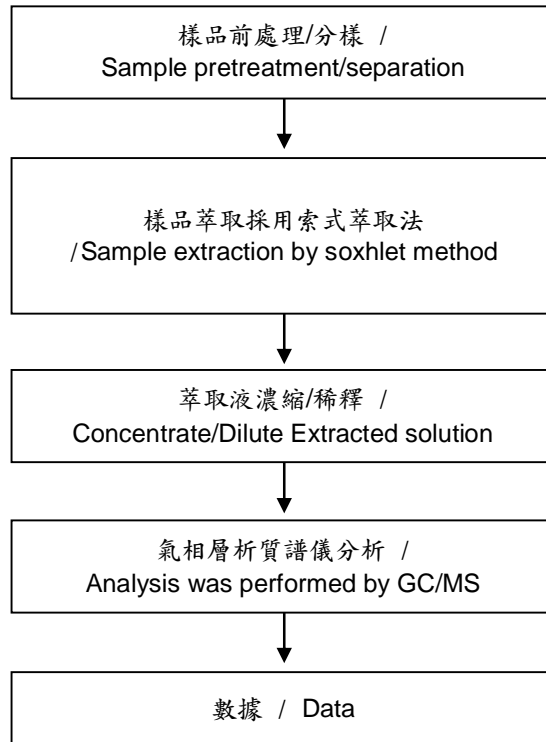

Unless otherwise stated the results shown in this test report refer only to the sample(s) tested. This test report cannot be reproduced, except in full, without prior written permission of the Company. 除非另有說明，此報告結果僅對測試之樣品負責。本報告未經本公司書面許可，不可部分複製。
This document is issued by the Company subject to its General Conditions of Service printed overleaf, available on request or accessible at www.sgs.com/terms_and_conditions.htm and, for electronic format documents, subject to Terms and Conditions for Electronic Documents at www.sgs.com/terms_e-document.htm. Attention is drawn to the limitation of liability, indemnification and jurisdiction issues defined therein. Any holder of this document is advised that information contained hereon reflects the Company's findings at the time of its intervention only and within the limits of Client's instructions, if any. The Company's sole responsibility is to its Client and this document does not exonerate parties to a transaction from exercising all their rights and obligations under the transaction documents. This document cannot be reproduced except in full, without prior written approval of the Company. Any unauthorized alteration, forgery or falsification of the content or appearance of this document is unlawful and offenders may be prosecuted to the fullest extent of the law.

測試報告

Test Report

號碼(No.) : KA/2013/61204 日期(Date) : 2013/07/04 頁數(Page) : 11 of 12

安天德百電股份有限公司
 ITW ELECTRONIC BUSINESS ASIA CO., LTD.
 高雄市前鎮加工出口區東六街3-2號
 A4, 3-2, K.E.P.Z. KAOHSIUNG, TAIWAN

六溴環十二烷分析流程圖 / HBCDD Analytical FLOW CHART

- 1) 測試人員：曹嘉琪/ Name of the person who made measurement: Anson Tsao
- 2) 測試負責人：張伯睿/ Name of the person in charge of measurement: Ray Chang

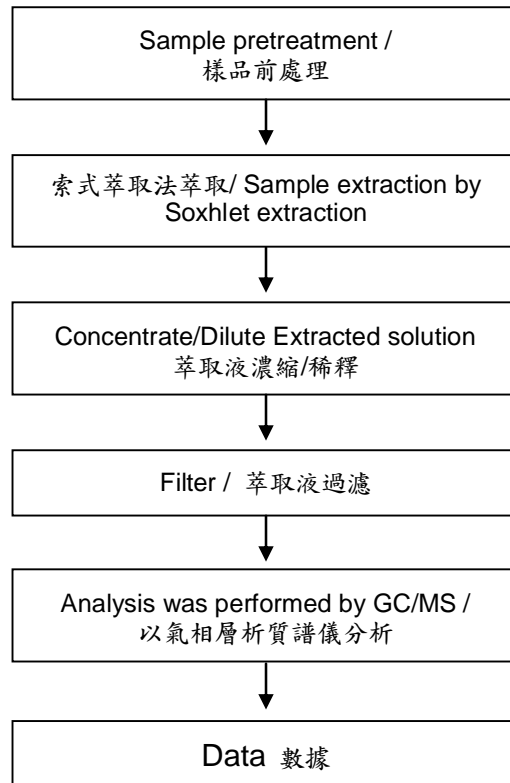

Unless otherwise stated the results shown in this test report refer only to the sample(s) tested. This test report cannot be reproduced, except in full, without prior written permission of the Company. 除非另有說明，此報告結果僅對測試之樣品負責。本報告未經本公司書面許可，不可部分複製。
 This document is issued by the Company subject to its General Conditions of Service printed overleaf, available on request or accessible at www.sgs.com/terms_and_conditions.htm and, for electronic format documents, subject to Terms and Conditions for Electronic Documents at www.sgs.com/terms_e-document.htm. Attention is drawn to the limitation of liability, indemnification and jurisdiction issues defined therein. Any holder of this document is advised that information contained hereon reflects the Company's findings at the time of its intervention only and within the limits of Client's instructions, if any. The Company's sole responsibility is to its Client and this document does not exonerate parties to a transaction from exercising all their rights and obligations under the transaction documents. This document cannot be reproduced except in full, without prior written approval of the Company. Any unauthorized alteration, forgery or falsification of the content or appearance of this document is unlawful and offenders may be prosecuted to the fullest extent of the law.

測試報告 Test Report

號碼(No.) : KA/2013/61204 日期(Date) : 2013/07/04 頁數(Page) : 12 of 12

安天德百電股份有限公司
ITW ELECTRONIC BUSINESS ASIA CO., LTD.
高雄市前鎮加工出口區東六街3-2號
A4, 3-2, K.E.P.Z. KAOHSIUNG, TAIWAN

* 照片中如有箭頭標示，則表示為實際檢測之樣品/部位。*
(The tested sample / part is marked by an arrow if it's shown on the photo.)

KA/2013/61204

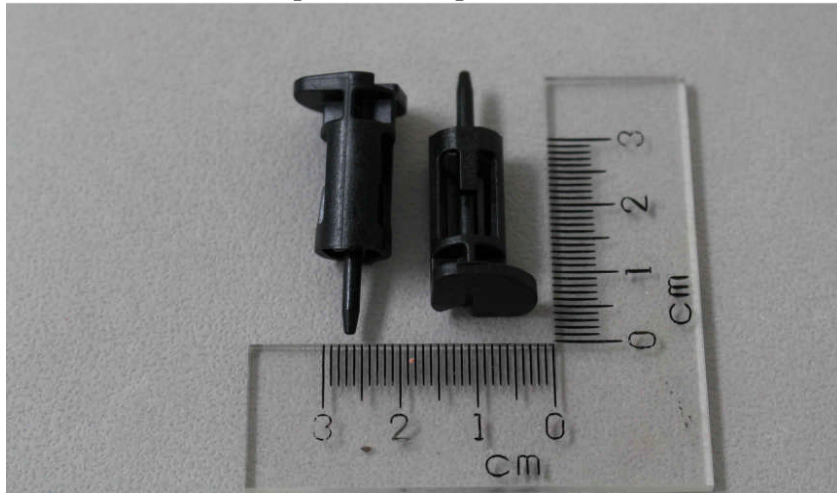

** 報告結尾(End of Report) **

Unless otherwise stated the results shown in this test report refer only to the sample(s) tested. This test report cannot be reproduced, except in full, without prior written permission of the Company. 除非另有說明，此報告結果僅對測試之樣品負責。本報告未經本公司書面許可，不可部分複製。
This document is issued by the Company subject to its General Conditions of Service printed overleaf, available on request or accessible at www.sgs.com/terms_and_conditions.htm and, for electronic format documents, subject to Terms and Conditions for Electronic Documents at www.sgs.com/terms_e-document.htm. Attention is drawn to the limitation of liability, indemnification and jurisdiction issues defined therein. Any holder of this document is advised that information contained hereon reflects the Company's findings at the time of its intervention only and within the limits of Client's instructions, if any. The Company's sole responsibility is to its Client and this document does not exonerate parties to a transaction from exercising all their rights and obligations under the transaction documents. This document cannot be reproduced except in full, without prior written approval of the Company. Any unauthorized alteration, forgery or falsification of the content or appearance of this document is unlawful and offenders may be prosecuted to the fullest extent of the law.

Test Results :

Test Part Description :

Specimen No.	SGS Sample ID	Description
1	CAN13-085260.001	Silvery film

Remarks :

- (1) 1 mg/kg = 1 ppm = 0.0001%
- (2) MDL = Method Detection Limit
- (3) ND = Not Detected (< MDL)
- (4) "-" = Not Regulated

Elementary Analysis & Flame Retardants

Test Method : With reference to IEC 62321:2008

- (1) Determination of Cadmium by ICP-OES.
- (2) Determination of Lead by ICP-OES.
- (3) Determination of Mercury by ICP-OES.
- (4) Determination of Hexavalent Chromium by Colorimetric Method using UV-Vis.
- (5) Determination of PBBs / PBDEs content by GC-MS.

<u>Test Item(s)</u>	<u>Unit</u>	<u>MDL</u>	<u>001</u>
Cadmium (Cd)	mg/kg	2	ND
Lead (Pb)	mg/kg	2	ND
Mercury (Hg)	mg/kg	2	ND
Hexavalent Chromium (CrVI)	mg/kg	2	ND
Sum of PBBs	mg/kg	-	ND
Monobromobiphenyl	mg/kg	5	ND
Dibromobiphenyl	mg/kg	5	ND
Tribromobiphenyl	mg/kg	5	ND
Tetrabromobiphenyl	mg/kg	5	ND
Pentabromobiphenyl	mg/kg	5	ND
Hexabromobiphenyl	mg/kg	5	ND
Heptabromobiphenyl	mg/kg	5	ND
Octabromobiphenyl	mg/kg	5	ND
Nonabromobiphenyl	mg/kg	5	ND
Decabromobiphenyl	mg/kg	5	ND
Sum of PBDEs	mg/kg	-	ND
Monobromodiphenyl ether	mg/kg	5	ND

This document is issued by the Company subject to its General Conditions of Service printed overleaf, available on request or accessible at http://www.sgs.com/terms_and_conditions.htm and, for electronic format documents, subject to Terms and Conditions for Electronic Documents at www.sgs.com/terms_e-document.htm. Attention is drawn to the limitation of liability, indemnification and jurisdiction issues defined therein. Any holder of this document is advised that information contained hereon reflects the Company's findings at the time of its preparation only and within the limits of Client's instructions, if any. The Company's sole responsibility is to its Client and this document does not exonerate parties to a transaction from exercising all their rights and obligations under the transaction documents. This document cannot be reproduced except in full, without prior written approval of the Company. Any unauthorized alteration, forgery or falsification of the content or appearance of this document is unlawful and offenders may be prosecuted to the fullest extent of the law. Unless otherwise stated, the results shown in this test report refer only to the sample(s) tested.

Test Report

No. CANEC1308526001

Date: 13 Jun 2013

Page 3 of 10

<u>Test Item(s)</u>	<u>Unit</u>	<u>MDL</u>	<u>001</u>
Dibromodiphenyl ether	mg/kg	5	ND
Tribromodiphenyl ether	mg/kg	5	ND
Tetrabromodiphenyl ether	mg/kg	5	ND
Pentabromodiphenyl ether	mg/kg	5	ND
Hexabromodiphenyl ether	mg/kg	5	ND
Heptabromodiphenyl ether	mg/kg	5	ND
Octabromodiphenyl ether	mg/kg	5	ND
Nonabromodiphenyl ether	mg/kg	5	ND
Decabromodiphenyl ether	mg/kg	5	ND

Halogen

Test Method : With reference to EN 14582: 2007, analysis was performed by Ion Chromatograph (IC).

<u>Test Item(s)</u>	<u>Unit</u>	<u>MDL</u>	<u>001</u>
Fluorine (F)	mg/kg	50	ND
Chlorine (Cl)	mg/kg	50	ND
Bromine (Br)	mg/kg	50	ND
Iodine (I)	mg/kg	50	ND

Hexabromocyclododecane (HBCDD)

Test Method : Determination of HBCDD by GC-MS based on IEC 62321:2008.

<u>Test Item(s)</u>	<u>Unit</u>	<u>MDL</u>	<u>001</u>
Hexabromocyclododecane (HBCDD)	mg/kg	10	ND

Notes :

- (1) Reference Information: Directive 2011/65/EU recasting RoHS directive 2002/95/EC:
Hexabromocyclododecane (HBCDD) is considered as a priority for risk evaluation and substance restriction.

Phthalate

Test Method : Determination of phthalates by GC-MS based on EN 14372:2004.

This document is issued by the Company subject to its General Conditions of Service printed overleaf, available on request or accessible at http://www.sgs.com/terms_and_conditions.htm and, for electronic format documents, subject to Terms and Conditions for Electronic Documents at www.sgs.com/terms_e-document.htm. Attention is drawn to the limitation of liability, indemnification and jurisdiction issues defined therein. Any holder of this document is advised that information contained hereon reflects the Company's findings at the time of its preparation only and within the limits of Client's instructions, if any. The Company's sole responsibility is to its Client and this document does not exonerate parties to a transaction from exercising all their rights and obligations under the transaction documents. This document cannot be reproduced except in full, without prior written approval of the Company. Any unauthorized alteration, forgery or falsification of the content or appearance of this document is unlawful and offenders may be prosecuted to the fullest extent of the law. Unless otherwise stated, the results shown in this test report refer only to the sample(s) tested.

Test Report

No. CANEC1308526001

Date: 13 Jun 2013

Page 4 of 10

<u>Test Item(s)</u>	<u>Unit</u>	<u>MDL</u>	<u>001</u>
Diisobutyl Phthalate (DIBP)	% (w/w)	0.003	ND
Dibutyl Phthalate (DBP)	% (w/w)	0.003	ND
Benzylbutyl Phthalate (BBP)	% (w/w)	0.003	ND
Bis-(2-ethylhexyl) Phthalate (DEHP)	% (w/w)	0.003	ND

Notes :

- (1) Reference Information: Directive 2011/65/EU recasting RoHS directive 2002/95/EC: Bis (2-ethylhexyl) phthalate (DEHP), Butyl benzyl phthalate (BBP) and Dibutyl phthalate (DBP) are considered as a priority for risk evaluation and substance restriction.

PFOS (Perfluorooctane Sulfonates)

Test Method : With reference to US EPA 3550C: 2007, analysis was performed by HPLC-MS.

<u>Test Item(s)</u>	<u>Unit</u>	<u>MDL</u>	<u>001</u>
Perfluorooctane Sulfonates (PFOS) and related Acid, Metal Salt and Amide	mg/kg	10	ND

Notes :

- For reference: commission regulation (EU) No 757/2010 amending regulation (EC) No 850/2004:
- (1) For the purposes of this entry, Article 4(1) (b) shall apply to concentrations of PFOS equal to or below 10 mg/kg (0,001 % by weight) when it occurs in substances or in preparations.
- (2) For the purposes of this entry, Article 4(1) (b) shall apply to concentrations of PFOS in semi-finished products or articles, or parts thereof, if the concentration of PFOS is lower than 0,1 % by weight calculated with reference to the mass of structurally or micro-structurally distinct parts that contain PFOS or, for textiles or other coated materials, if the amount of PFOS is lower than 1µg /m2 of the coated material.

This document is issued by the Company subject to its General Conditions of Service printed overleaf, available on request or accessible at http://www.sgs.com/terms_and_conditions.htm and, for electronic format documents, subject to Terms and Conditions for Electronic Documents at www.sgs.com/terms_e-document.htm. Attention is drawn to the limitation of liability, indemnification and jurisdiction issues defined therein. Any holder of this document is advised that information contained hereon reflects the Company's findings at the time of its preparation only and within the limits of Client's instructions, if any. The Company's sole responsibility is to its Client and this document does not exonerate parties to a transaction from exercising all their rights and obligations under the transaction documents. This document cannot be reproduced except in full, without prior written approval of the Company. Any unauthorized alteration, forgery or falsification of the content or appearance of this document is unlawful and offenders may be prosecuted to the fullest extent of the law. Unless otherwise stated, the results shown in this test report refer only to the sample(s) tested.

ATTACHMENTS

RoHS Testing Flow Chart

- 1) Name of the person who made testing: Michael Tso / Cutey Yu
- 2) Name of the person in charge of testing: Adams Yu / Yolanda Wei
- 3) These samples were dissolved totally by pre-conditioning method according to below flow chart (Cr⁶⁺ and PBBs/PBDEs test method excluded).

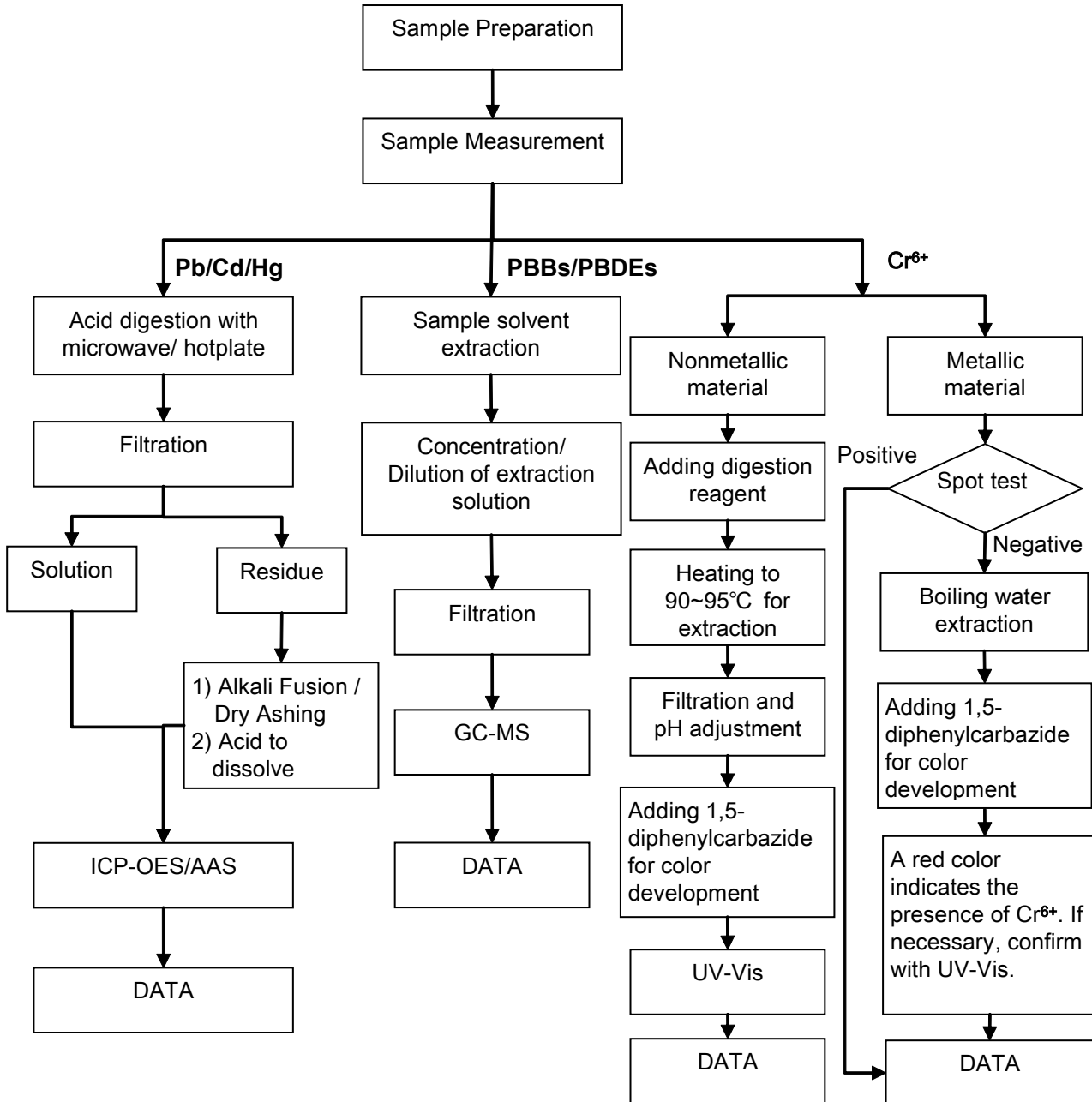

This document is issued by the Company subject to its General Conditions of Service printed overleaf, available on request or accessible at http://www.sgs.com/terms_and_conditions.htm and, for electronic format documents, subject to Terms and Conditions for Electronic Documents at www.sgs.com/terms_e-document.htm. Attention is drawn to the limitation of liability, indemnification and jurisdiction issues defined therein. Any holder of this document is advised that information contained hereon reflects the Company's findings at the time of its preparation only and within the limits of Client's instructions, if any. The Company's sole responsibility is to its Client and this document does not exonerate parties to a transaction from exercising all their rights and obligations under the transaction documents. This document cannot be reproduced except in full, without prior written approval of the Company. Any unauthorized alteration, forgery or falsification of the content or appearance of this document is unlawful and offenders may be prosecuted to the fullest extent of the law. Unless otherwise stated, the results shown in this test report refer only to the sample(s) tested.

ATTACHMENTS

Phthalates Testing Flow Chart

- 1) Name of the person who made testing: Liu Qiong
- 2) Name of the person in charge of testing: Yolanda Wei

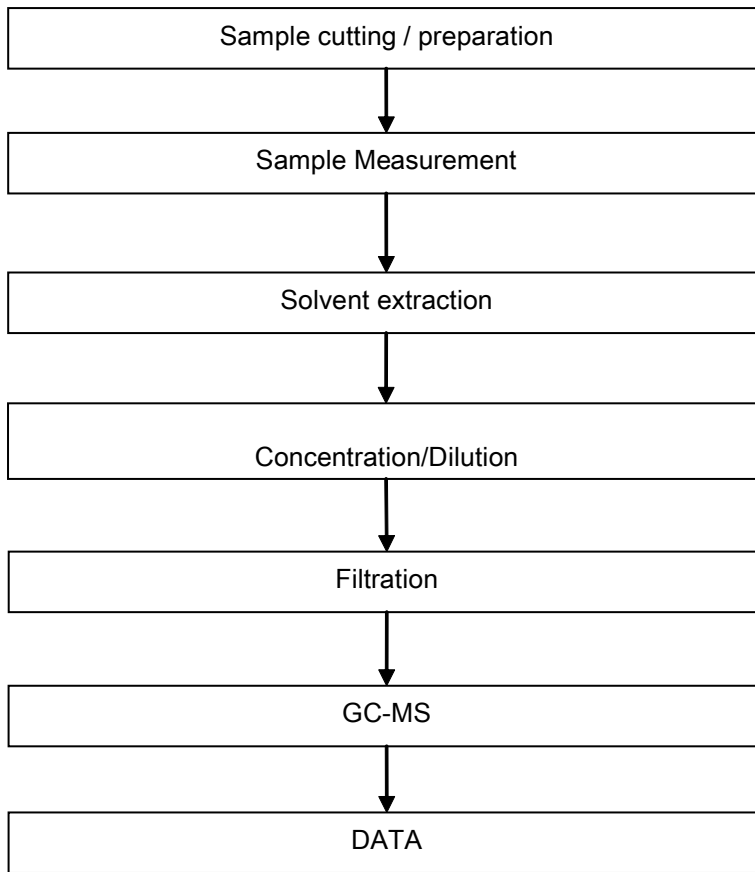

This document is issued by the Company subject to its General Conditions of Service printed overleaf, available on request or accessible at http://www.sgs.com/terms_and_conditions.htm and, for electronic format documents, subject to Terms and Conditions for Electronic Documents at www.sgs.com/terms_e-document.htm. Attention is drawn to the limitation of liability, indemnification and jurisdiction issues defined therein. Any holder of this document is advised that information contained hereon reflects the Company's findings at the time of its preparation only and within the limits of Client's instructions, if any. The Company's sole responsibility is to its Client and this document does not exonerate parties to a transaction from exercising all their rights and obligations under the transaction documents. This document cannot be reproduced except in full, without prior written approval of the Company. Any unauthorized alteration, forgery or falsification of the content or appearance of this document is unlawful and offenders may be prosecuted to the fullest extent of the law. Unless otherwise stated, the results shown in this test report refer only to the sample(s) tested.

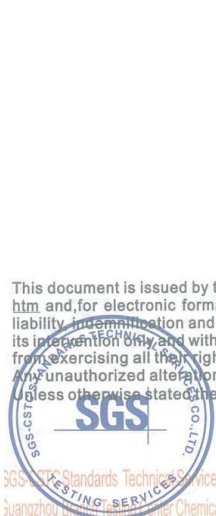

ATTACHMENTS

HBCDD Testing Flow Chart

- 1) Name of the person who made testing: Cutey Yu
- 2) Name of the person in charge of testing: Yolanda Wei

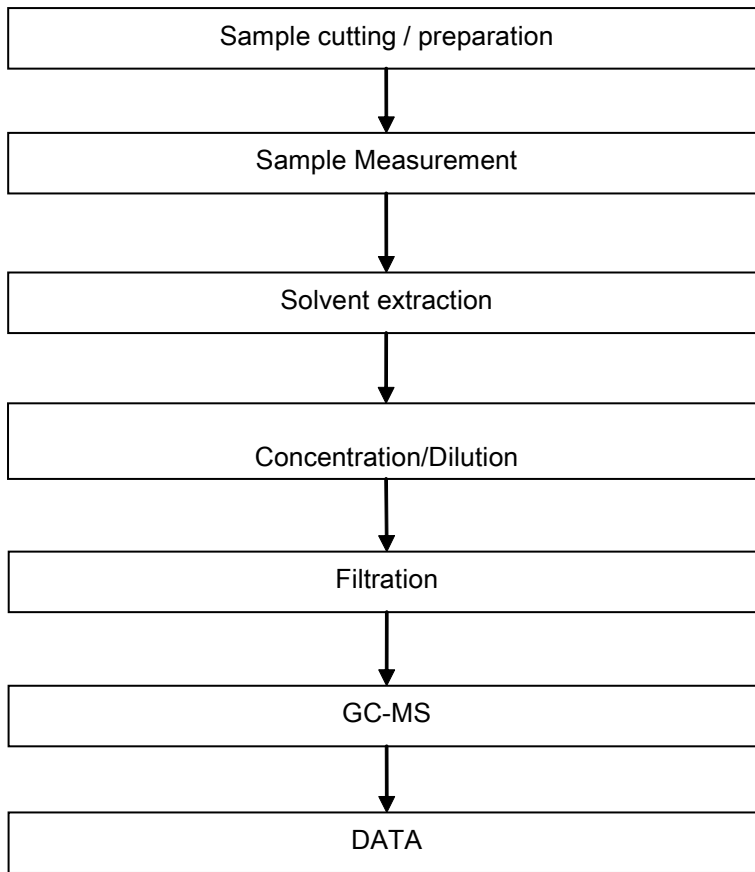

This document is issued by the Company subject to its General Conditions of Service printed overleaf, available on request or accessible at http://www.sgs.com/terms_and_conditions.htm and, for electronic format documents, subject to Terms and Conditions for Electronic Documents at www.sgs.com/terms_e-document.htm. Attention is drawn to the limitation of liability, indemnification and jurisdiction issues defined therein. Any holder of this document is advised that information contained hereon reflects the Company's findings at the time of its preparation only and within the limits of Client's instructions, if any. The Company's sole responsibility is to its Client and this document does not exonerate parties to a transaction from exercising all their rights and obligations under the transaction documents. This document cannot be reproduced except in full, without prior written approval of the Company. Any unauthorized alteration, forgery or falsification of the content or appearance of this document is unlawful and offenders may be prosecuted to the fullest extent of the law. Unless otherwise stated, the results shown in this test report refer only to the sample(s) tested.

ATTACHMENTS

PFOA / PFOS Testing Flow Chart

- 1) Name of the person who made testing: Tina Zhao
- 2) Name of the person in charge of testing: Yolanda Wei

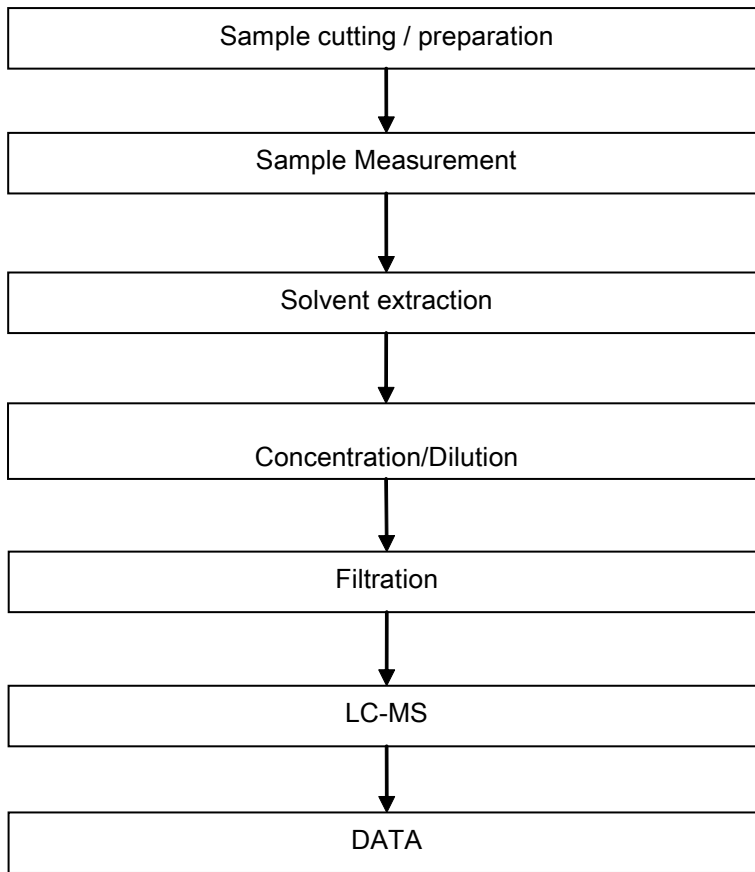

This document is issued by the Company subject to its General Conditions of Service printed overleaf, available on request or accessible at http://www.sgs.com/terms_and_conditions.htm and, for electronic format documents, subject to Terms and Conditions for Electronic Documents at www.sgs.com/terms_e-document.htm. Attention is drawn to the limitation of liability, indemnification and jurisdiction issues defined therein. Any holder of this document is advised that information contained hereon reflects the Company's findings at the time of its preparation only and within the limits of Client's instructions, if any. The Company's sole responsibility is to its Client and this document does not exonerate parties to a transaction from exercising all their rights and obligations under the transaction documents. This document cannot be reproduced except in full, without prior written approval of the Company. Any unauthorized alteration, forgery or falsification of the content or appearance of this document is unlawful and offenders may be prosecuted to the fullest extent of the law. Unless otherwise stated, the results shown in this test report refer only to the sample(s) tested.

ATTACHMENTS

Halogen Testing Flow Chart

- 1) Name of the person who made testing: Bella Wang
- 2) Name of the person in charge of testing: Adams Yu

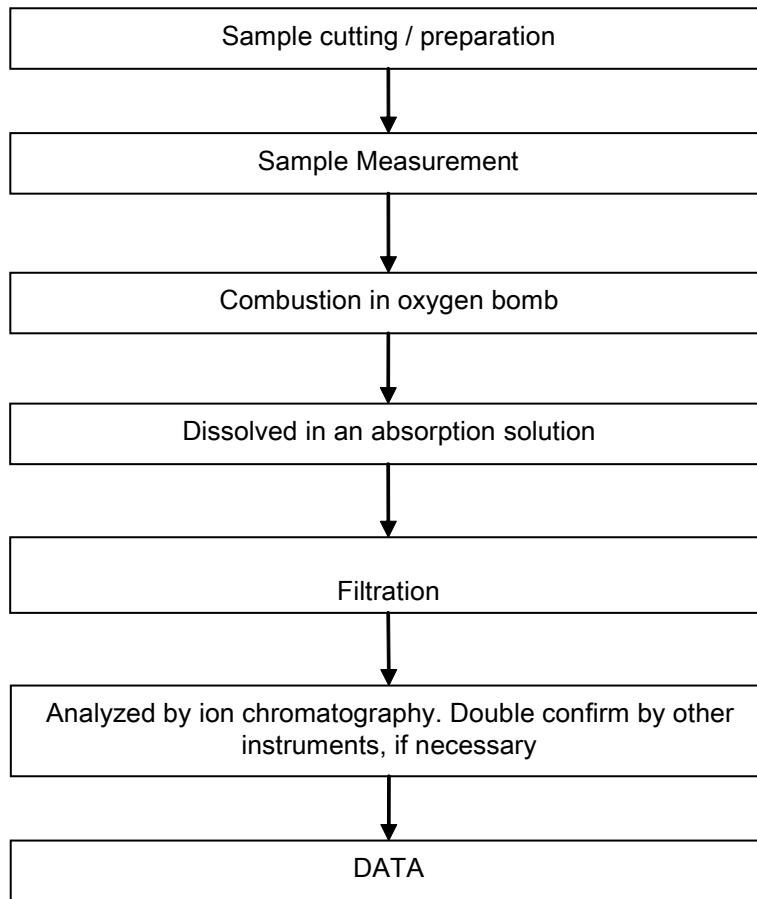

This document is issued by the Company subject to its General Conditions of Service printed overleaf, available on request or accessible at http://www.sgs.com/terms_and_conditions.htm and, for electronic format documents, subject to Terms and Conditions for Electronic Documents at www.sgs.com/terms_e-document.htm. Attention is drawn to the limitation of liability, indemnification and jurisdiction issues defined therein. Any holder of this document is advised that information contained hereon reflects the Company's findings at the time of its preparation only and within the limits of Client's instructions, if any. The Company's sole responsibility is to its Client and this document does not exonerate parties to a transaction from exercising all their rights and obligations under the transaction documents. This document cannot be reproduced except in full, without prior written approval of the Company. Any unauthorized alteration, forgery or falsification of the content or appearance of this document is unlawful and offenders may be prosecuted to the fullest extent of the law. Unless otherwise stated, the results shown in this test report refer only to the sample(s) tested.

Test Report

Report No. RLSZF001577440003

Page 1 of 6

Applicant DONGGUAN SUNWAY PRINTING INDUSTRY CO.,LTD
Address YINLING INDUSTRIAL, XIAQIAO GUANLONG ROAD, DONGCHENG ZONE,
DONGGUAN CITY, GUANGDONG PROVINCE, CHINA

The following sample(s) and sample information was/were submitted and identified by/on the behalf of the client

Sample Name INK
Part No. 新宝龙黑
Color Black
Material INK
Manufacturer 深日
Sample Received Date Feb. 2, 2013
Testing Period Feb. 2, 2013 to Feb. 6, 2013

Test Requested As specified by client, to test Lead(Pb), Cadmium(Cd), Mercury(Hg), Hexavalent Chromium(Cr(VI)), Polybrominated Biphenyls(PBBs), Polybrominated Diphenyl Ethers(PBDEs), Fluorine(F), Chlorine(Cl), Bromine(Br), Iodine(I), Hexabromocyclododecane(HBCDD), Phthalates in the submitted sample(s).

Test Method Please refer to the following page(s).

Test Result(s) Please refer to the following page(s).

Tested by

Rick Li

Reviewed by

Vargas He

Approved by

Danny Liu

Date

Feb. 6, 2013

Danny Liu

Technical Manager

No. 14465604

Centre Testing International (Shenzhen) Co., Ltd. Hongwei Industrial Zone, Bao'an 70 District, Shenzhen, Guangdong, China

Test Report

Report No. RLSZF001577440003

Page 2 of 6

Test Method

Test Item(s)	Test Method	Measured Equipment(s)	MDL
Lead(Pb)	IEC 62321:2008 Ed.1 Sec.10	ICP-OES	2 mg/kg
Cadmium(Cd)	IEC 62321:2008 Ed.1 Sec.10	ICP-OES	2 mg/kg
Mercury(Hg)	IEC 62321:2008 Ed.1 Sec.7	ICP-OES	2 mg/kg
Hexavalent Chromium(Cr(VI))	IEC 62321:2008 Ed.1 Annex C	UV-Vis	2 mg/kg
Polybrominated Biphenyls(PBBs)	IEC 62321:2008 Ed.1 Annex A	GC-MS	5 mg/kg
Polybrominated Diphenyl Ethers(PBDEs)	IEC 62321:2008 Ed.1 Annex A	GC-MS	5 mg/kg
Fluorine(F)	Refer to BS EN 14582:2007	IC	10 mg/kg
Chlorine(Cl)	Refer to BS EN 14582:2007	IC	10 mg/kg
Bromine(Br)	Refer to BS EN 14582:2007	IC	10 mg/kg
Iodine(I)	Refer to BS EN 14582:2007	IC	10 mg/kg
Phthalates	Refer to EN 14372:2004	GC-MS	50 mg/kg
Hexabromocyclododecane(HBCDD)	Refer to US EPA 3540C:1996	GC-MS	5 mg/kg

Test Result(s)

Tested Item(s)	Result
Lead(Pb)	N.D.
Cadmium (Cd)	N.D.
Mercury(Hg)	N.D.
Hexavalent Chromium(Cr(VI))	N.D.

Tested Item(s)	Result
Polybrominated Biphenyls(PBBs)	
Monobromobiphenyl	N.D.
Dibromobiphenyl	N.D.
Tribromobiphenyl	N.D.
Tetrabromobiphenyl	N.D.
Pentabromobiphenyl	N.D.
Hexabromobiphenyl	N.D.
Heptabromobiphenyl	N.D.
Octabromobiphenyl	N.D.
Nonabromobiphenyl	N.D.
Decabromobiphenyl	N.D.

Test Report

Report No. RLSZF001577440003

Page 3 of 6

Tested Item(s)	Result
Polybrominated Diphenyl Ethers(PBDEs)	
Monobromodiphenyl ether	N.D.
Dibromodiphenyl ether	N.D.
Tribromodiphenyl ether	N.D.
Tetrabromodiphenyl ether	N.D.
Pentabromodiphenyl ether	N.D.
Hexabromodiphenyl ether	N.D.
Heptabromodiphenyl ether	N.D.
Octabromodiphenyl ether	N.D.
Nonabromodiphenyl ether	N.D.
Decabromodiphenyl ether	N.D.

Tested Item(s)	Result
Halogen(s)	
Fluorine (F)	994 mg/kg
Chlorine (Cl)	251 mg/kg
Bromine (Br)	N.D.
Iodine (I)	N.D.

Tested Item(s)	Result
Hexabromocyclododecane (HBCDD)	N.D.

Tested Item(s)	CAS No.	EC No.	Result
Phthalates			
Diisobutyl phthalate(DIBP)	84-69-5	201-553-2	N.D.
Dibutyl phthalate(DBP)	84-74-2	201-557-4	N.D.
Butylbenzyl phthalate(BBP)	85-68-7	201-622-7	N.D.
Di-2-ethylhexyl phthalate(DEHP)	117-81-7	204-211-0	N.D.
Di-n-octyl phthalate(DNOP)	117-84-0	204-214-7	N.D.
Diisononyl phthalate(DINP)	28553-12-0	249-079-5	N.D.
Diisodecyl phthalate(DIDP)	26761-40-0	247-977-1	N.D.
Di-n-hexyl phthalate (DNHP)	84-75-3	201-559-5	N.D.
Dimethoxyethyl phthalate (DMEP)	117-82-8	204-212-6	N.D.

Tested Sample/Part Description Black ink

Note: **The sample(s) had been dissolved totally tested for Lead, Cadmium, Mercury.**

- MDL = Method Detection Limit
- N.D. = Not Detected (<MDL)
- mg/kg = ppm = parts per million

Test Report

Report No. RLSZF001577440003

Page 4 of 6

Test Process

1. Lead(Pb), Cadmium(Cd)

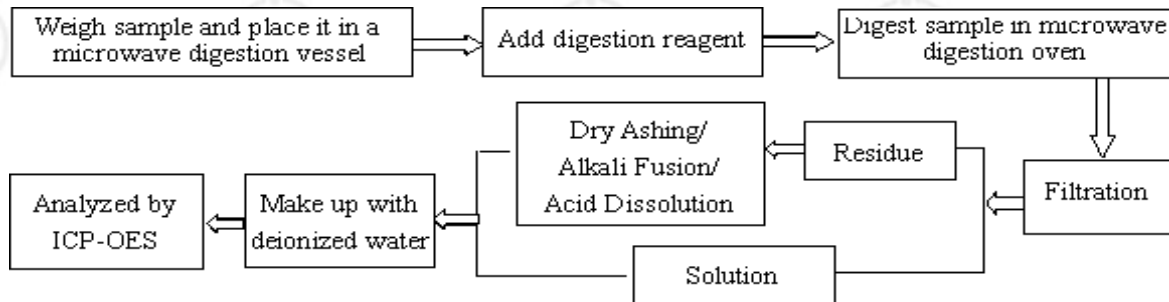

2. Mercury(Hg)

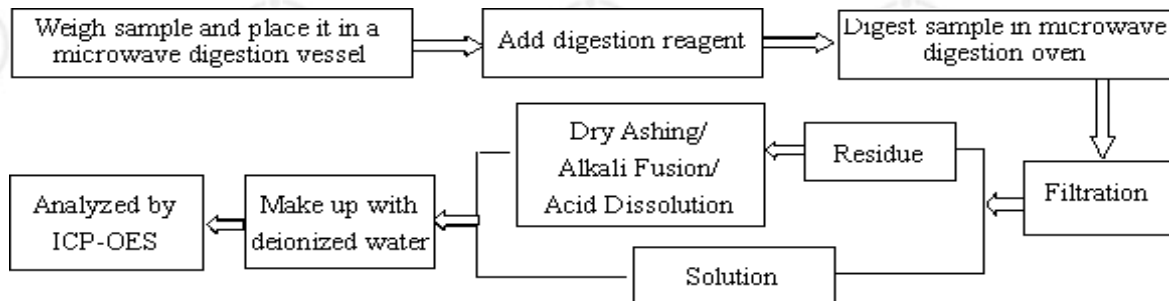

3. Hexavalent Chromium(Cr(VI))

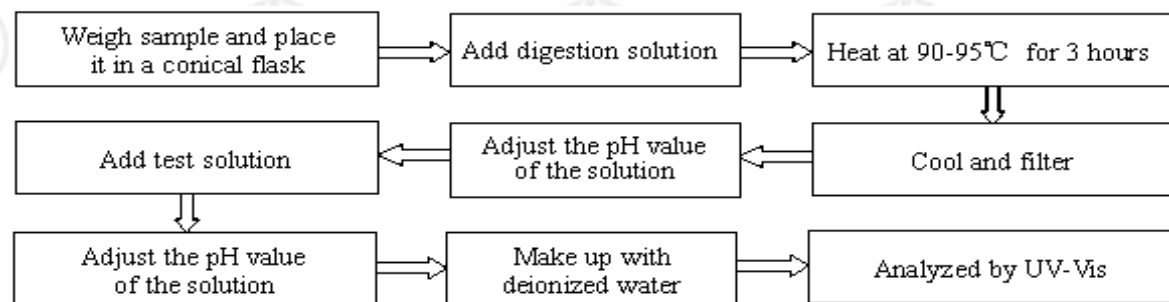

4. Phthalates

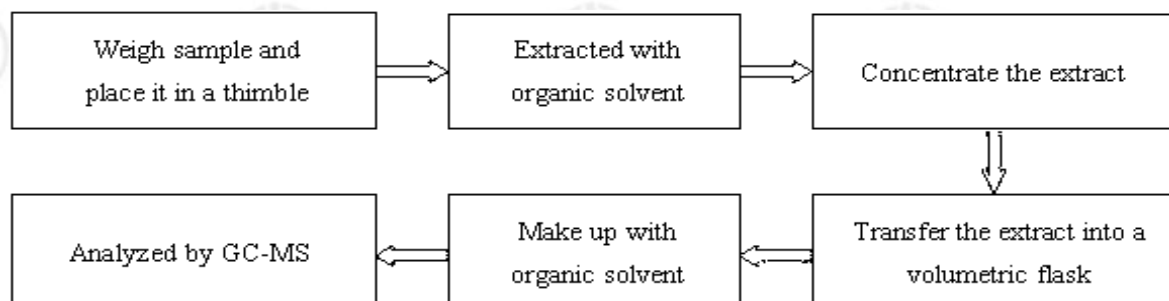

Test Report

Report No. RLSZF001577440003

Page 5 of 6

5. Polybrominated Biphenyls(PBBs), Polybrominated Diphenyl Ethers(PBDEs)

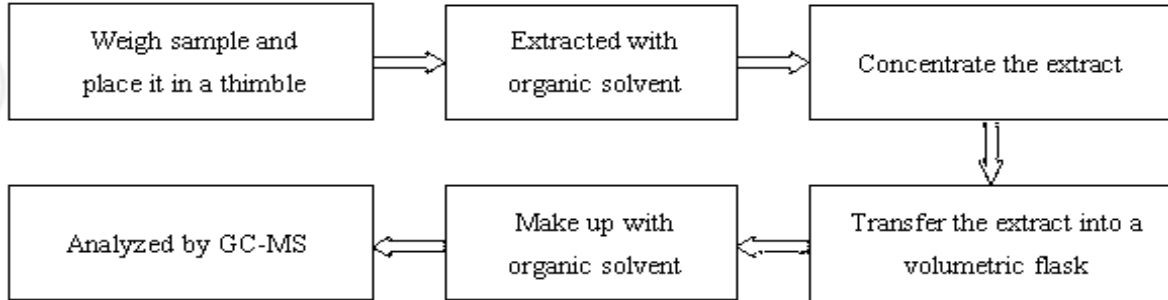

6. Hexabromocyclododecane(HBCDD)

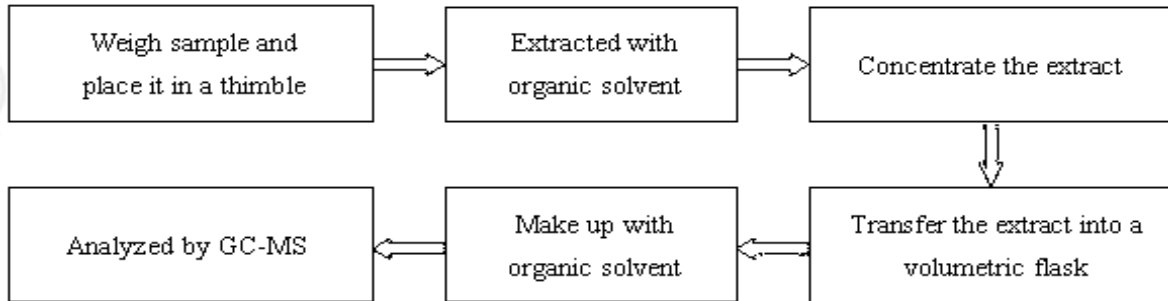

7. Fluorine(F), Chlorine(Cl), Bromine(Br), Iodine(I)

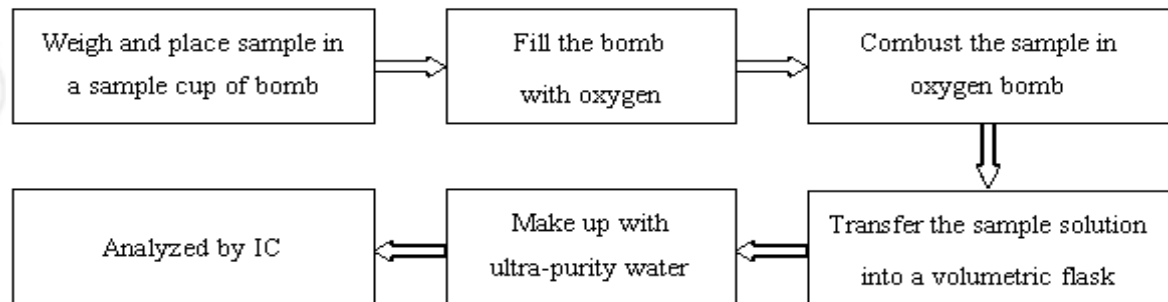

Test Report

Report No. RLSZF001577440003

Page 6 of 6

Photo(s) of the sample(s)



*** End of report ***

The test report is effective only with both signature and specialized stamp. The result(s) shown in this report refer only to the sample(s) tested. Without written approval of CTI, this report can't be reproduced except in full.

Test Report

Report No. RHS01F005977001

Page 1 of 6

Applicant DONGGUAN SUNWAY PRINTING INDUSTRY CO.,LTD
Address YINLING INDUSTRIAL, XIAQIAO GUANLONG ROAD, DONGCHENG ZONE,
DONGGUAN CITY, GUANGDONG PROVINCE, CHINA

The following sample(s) and sample information was/were submitted and identified by/on the behalf of the client

Sample Name 上光PP膜
Part No. (OPAT)
Sample Received Date Jun. 27, 2013
Testing Period Jun. 27, 2013 to Jun. 29, 2013

Test Requested As specified by client, to test Lead(Pb), Cadmium(Cd), Mercury(Hg), Hexavalent Chromium(Cr(VI)), Polybrominated Biphenyls(PBBs), Polybrominated Diphenyl Ethers(PBDEs), Hexabromocyclododecane(HBCDD), Phthalates, Fluorine(F), Chlorine(Cl), Bromine(Br), Iodine(I) in the submitted sample and it was tested as a whole.

Test Method Please refer to the following page(s).

Test Result(s) Please refer to the following page(s).

Tested by

Rick Li

Reviewed by

Vargas He

Approved by

Danny Liu

Date

Jun. 29, 2013

Danny Liu

Technical Manager

No. 1078468321

Centre Testing International (Shenzhen) Co., Ltd. Hongwei Industrial Zone, Bao'an 70 District, Shenzhen, Guangdong, China

Test Report

Report No. RHS01F005977001

Page 2 of 6

Test Method

Test Item(s)	Test Method	Measured Equipment(s)
Lead(Pb)	IEC 62321:2008 Ed.1 Sec.8	ICP-OES
Cadmium(Cd)	IEC 62321:2008 Ed.1 Sec.8	ICP-OES
Mercury(Hg)	IEC 62321:2008 Ed.1 Sec.7	ICP-OES
Hexavalent Chromium(Cr(VI))	IEC 62321:2008 Ed.1 Annex C	UV-Vis
Polybrominated Biphenyls(PBBs)	IEC 62321:2008 Ed.1 Annex A	GC-MS
Polybrominated Diphenyl Ethers(PBDEs)	IEC 62321:2008 Ed.1 Annex A	GC-MS
Fluorine(F)	Refer to BS EN 14582:2007	IC
Chlorine(Cl)	Refer to BS EN 14582:2007	IC
Bromine(Br)	Refer to BS EN 14582:2007	IC
Iodine(I)	Refer to BS EN 14582:2007	IC
Hexabromocyclododecane(HBCDD)	Refer to US EPA 3540C:1996	GC-MS
Phthalates	Refer to EN 14372:2004(E)	GC-MS

Test Result(s)

Tested Item(s)	Result	MDL
Lead(Pb)	N.D.	2 mg/kg
Cadmium (Cd)	N.D.	2 mg/kg
Mercury(Hg)	N.D.	2 mg/kg
Hexavalent Chromium(Cr(VI))	N.D.	2 mg/kg

Tested Item(s)	Result	MDL
Polybrominated Biphenyls(PBBs)		
Monobromobiphenyl	N.D.	5 mg/kg
Dibromobiphenyl	N.D.	5 mg/kg
Tribromobiphenyl	N.D.	5 mg/kg
Tetrabromobiphenyl	N.D.	5 mg/kg
Pentabromobiphenyl	N.D.	5 mg/kg
Hexabromobiphenyl	N.D.	5 mg/kg
Heptabromobiphenyl	N.D.	5 mg/kg
Octabromobiphenyl	N.D.	5 mg/kg
Nonabromobiphenyl	N.D.	5 mg/kg
Decabromobiphenyl	N.D.	5 mg/kg

Test Report

Report No. RHS01F005977001

Page 3 of 6

Tested Item(s)	Result	MDL
Polybrominated Diphenyl Ethers(PBDEs)		
Monobromodiphenyl ether	N.D.	5 mg/kg
Dibromodiphenyl ether	N.D.	5 mg/kg
Tribromodiphenyl ether	N.D.	5 mg/kg
Tetrabromodiphenyl ether	N.D.	5 mg/kg
Pentabromodiphenyl ether	N.D.	5 mg/kg
Hexabromodiphenyl ether	N.D.	5 mg/kg
Heptabromodiphenyl ether	N.D.	5 mg/kg
Octabromodiphenyl ether	N.D.	5 mg/kg
Nonabromodiphenyl ether	N.D.	5 mg/kg
Decabromodiphenyl ether	N.D.	5 mg/kg

Tested Item(s)	Result	MDL
Halogen(s)		
Fluorine (F)	N.D.	10 mg/kg
Chlorine (Cl)	N.D.	10 mg/kg
Bromine (Br)	N.D.	10 mg/kg
Iodine (I)	N.D.	10 mg/kg

Tested Item(s)	Result	MDL
Hexabromocyclododecane (HBCDD)	N.D.	5 mg/kg

Tested Item(s)	Result	MDL
Phthalates		
Dibutyl phthalate(DBP) CAS#:84-74-2	N.D.	50 mg/kg
Benzylbutyl phthalate(BBP) CAS#:85-68-7	N.D.	50 mg/kg
Di-2-ethylhexyl phthalate(DEHP) CAS#:117-81-7	N.D.	50 mg/kg

Tested Sample/Part Description Transparent plastic film with adhesive paste

Note:

- As specified by client, the sample was tested as a whole. The result(s) shown on this report may be different from the content of any homogeneous material.
- MDL = Method Detection Limit
- N.D. = Not Detected (<MDL)
- mg/kg = ppm = parts per million

Test Report

Report No. RHS01F005977001

Page 4 of 6

Test Process

1. Lead(Pb), Cadmium(Cd)

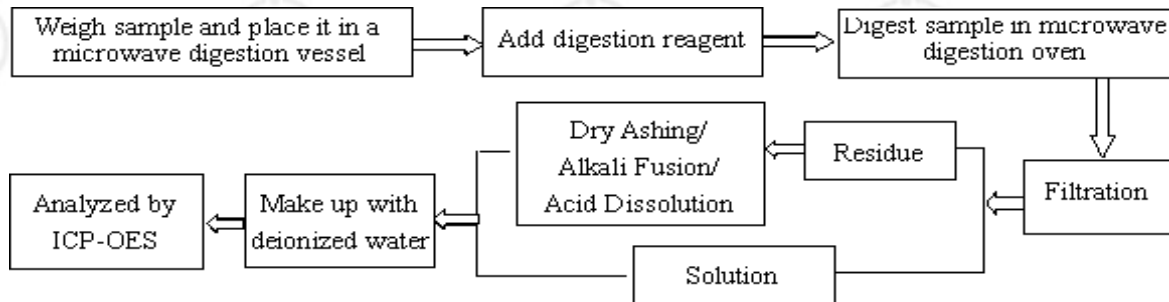

2. Mercury(Hg)

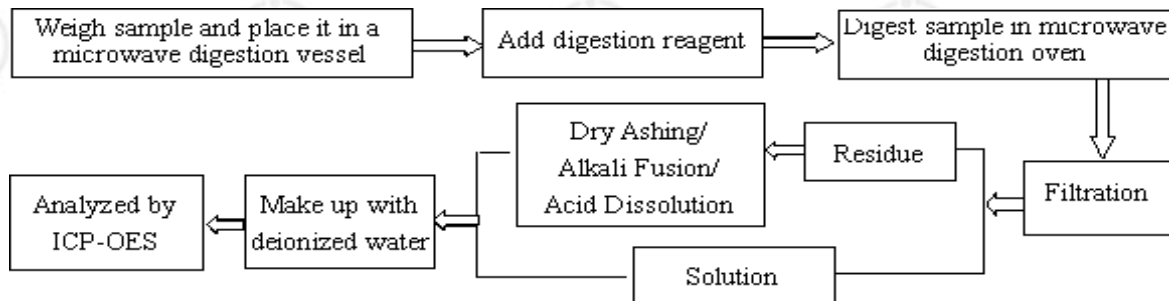

3. Hexavalent Chromium(Cr(VI))

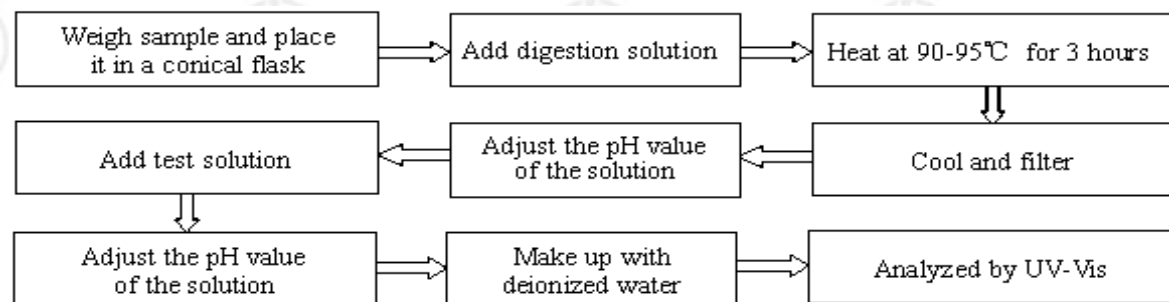

4. Phthalates

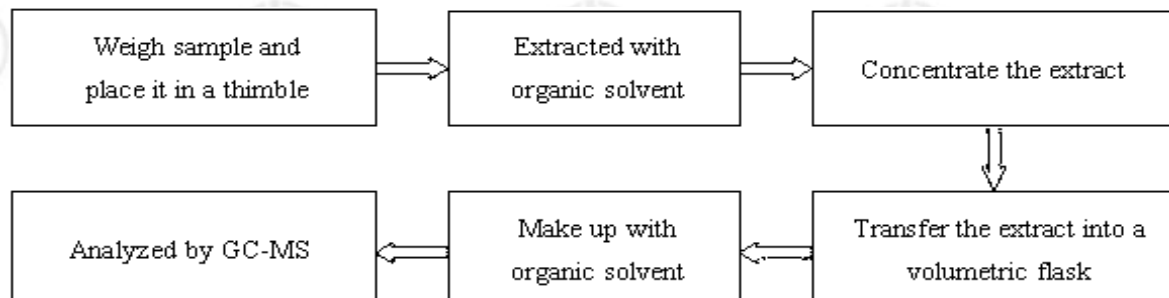

Test Report

Report No. RHS01F005977001

Page 5 of 6

5. Polybrominated Biphenyls(PBBs), Polybrominated Diphenyl Ethers(PBDEs)

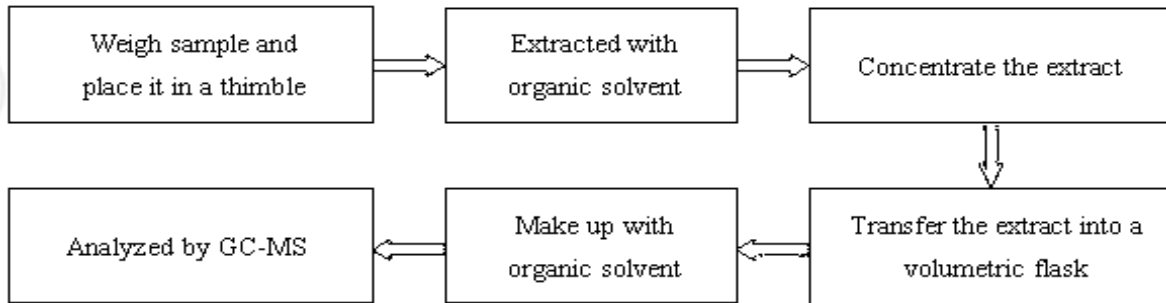

6. Hexabromocyclododecane(HBCDD)

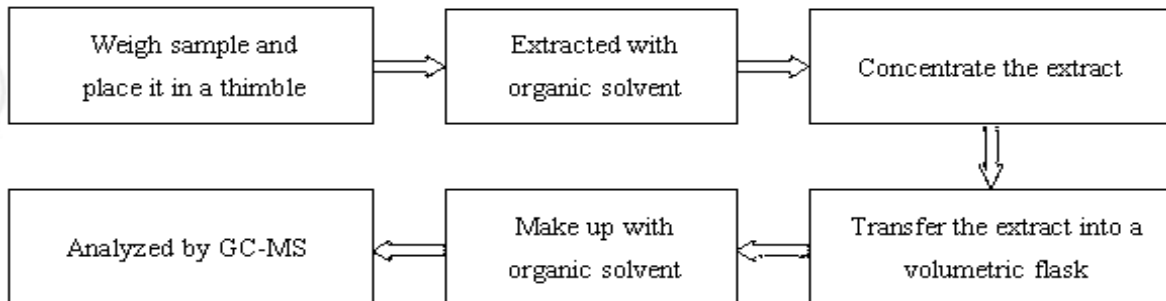

7. Fluorine(F), Chlorine(Cl), Bromine(Br), Iodine(I)

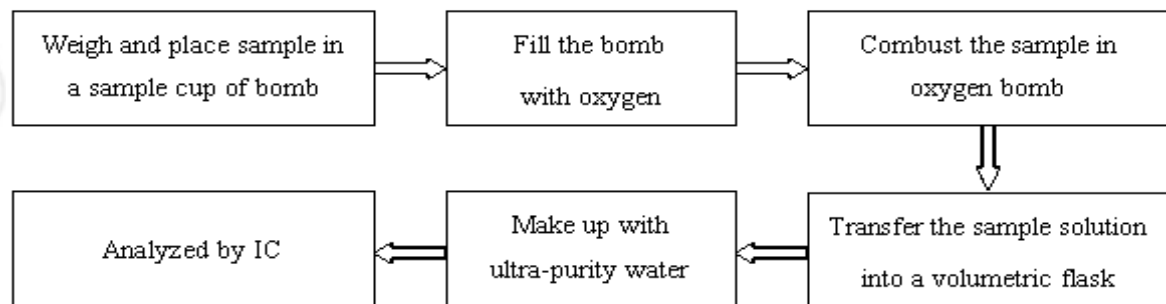

Test Report

Report No. RHS01F005977001

Page 6 of 6

Photo(s) of the sample(s)

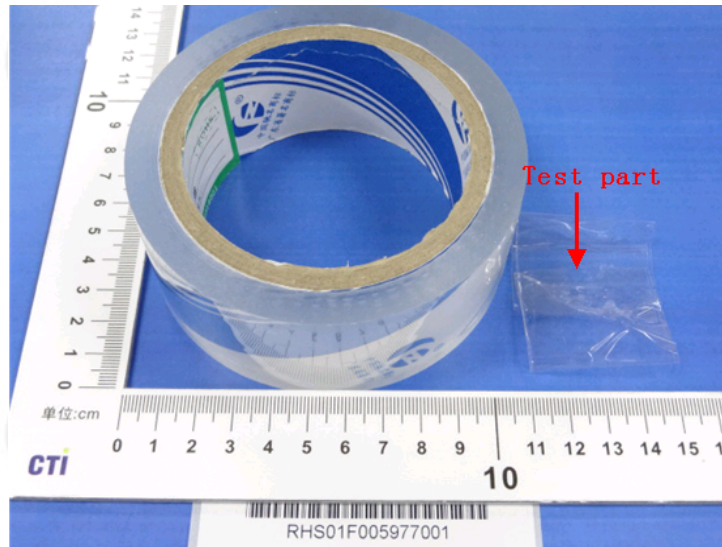

*** End of report ***

The test report is effective only with both signature and specialized stamp. The result(s) shown in this report refer only to the sample(s) tested. Without written approval of CTI, this report can't be reproduced except in full.

測試報告

Test Report

號碼(No.) : CE/2015/53008

日期(Date) : 2015/05/20

頁數(Page): 1 of 11

喬越實業有限公司

SIL-MORE INDUSTRIAL LTD.

新北市三重區興德路100號16樓

16F, NO. 100, XINGDE RD., SANCHONG DISTRICT, NEW TAIPEI CITY 24158, TAIWAN



以下測試樣品係由申請廠商所提供及確認 (The following sample(s) was/were submitted and identified by/on behalf of the applicant as) :

樣品名稱(Sample Description) : DOW CORNING TC-5630 THERMALLY CONDUCTIVE COMPOUND

收件日期(Sample Receiving Date) : 2015/05/14

測試期間(Testing Period) : 2015/05/14 TO 2015/05/20

=====
測試需求(Test Requested) :

- (1) 依據客戶要求, 參考RoHS 2011/65/EU Annex II 指令測試鎘、鉛、汞、六價鉻、多溴聯苯、多溴聯苯醚. (As specified by client, with reference to RoHS Directive 2011/65/EU Annex II to determine Cadmium, Lead, Mercury, Cr(VI), PBBs, PBDEs contents in the submitted sample.)
- (2) 依據客戶要求, 參考 WTO/TBT 通報 G/TBT/N/EU/256, 檢測 DBP, BBP, DEHP, DIBP. (As specified by client, with reference to G/TBT/N/EU/256 of WTO/TBT to test DBP, BBP, DEHP, DIBP.)
- (3) 其他測試項目請見下一頁 . / Please refer to next pages for the other item(s).

測試結果(Test Results) : 請見下一頁 (Please refer to next pages).

Troy Chang Manager - Tech
Signed for and on behalf of
SGS TAIWAN LTD.
Chemical Laboratory - Taipei

This document is issued by the Company subject to its General Conditions of Service printed overleaf, available on request or accessible at <http://www.sgs.com/en/Terms-and-Conditions.aspx> and, for electronic format documents, subject to Terms and Conditions for Electronic Documents at <http://www.sgs.com/en/Terms-and-Conditions/Termse-Documents.aspx>. Attention is drawn to the limitation of liability, indemnification and jurisdiction issues defined therein. Any holder of this document is advised that information contained hereon reflects the Company's findings at the time of its intervention only and within the limits of client's instruction, if any. The Company's sole responsibility is to its Client and this document does not exonerate parties to a transaction from exercising all their rights and obligations under the transaction documents. This document cannot be reproduced, except in full, without prior written approval of the Company. Any unauthorized alteration, forgery or falsification of the content or appearance of this document is unlawful and offenders may be prosecuted to the fullest extent of the law. Unless otherwise stated the results shown in this test report refer only to the sample(s) tested.

測試報告 Test Report

號碼(No.) : CE/2015/53008

日期(Date) : 2015/05/20

頁數(Page): 2 of 11

喬越實業有限公司

SIL-MORE INDUSTRIAL LTD.

新北市三重區興德路100號16樓

16F, NO. 100, XINGDE RD., SANCHONG DISTRICT, NEW TAIPEI CITY 24158, TAIWAN



測試結果(Test Results)

測試部位(PART NAME)No.1 : 灰色膏狀 (GRAY PASTE)

測試項目 (Test Items)	單位 (Unit)	測試方法 (Method)	方法偵測 極限值 (MDL)	結果 (Result)
				No.1
鎘 / Cadmium (Cd)	mg/kg	參考IEC 62321-5: 2013方法, 以感應 耦合電漿原子發射光譜儀檢測。 / With reference to IEC 62321-5: 2013 and performed by ICP-AES.	2	n.d.
鉛 / Lead (Pb)	mg/kg	參考IEC 62321-5: 2013方法, 以感應 耦合電漿原子發射光譜儀檢測。 / With reference to IEC 62321-5: 2013 and performed by ICP-AES.	2	n.d.
汞 / Mercury (Hg)	mg/kg	參考IEC 62321-4: 2013方法, 以感應 耦合電漿原子發射光譜儀檢測。 / With reference to IEC 62321-4: 2013 and performed by ICP-AES.	2	n.d.
六價鉻 / Hexavalent Chromium Cr(VI)	mg/kg	參考IEC 62321: 2008方法, 以UV-VIS 檢測。 / With reference to IEC 62321: 2008 and performed by UV- VIS.	2	n.d.
鄰苯二甲酸二異丁酯 / DIBP (Di- isobutyl phthalate) (CAS No.: 84-69- 5)	mg/kg	參考IEC 62321-8 (111/321/CD), 以氣 相層析儀/質譜儀檢測之。 / With reference to IEC 62321-8 (111/321/CD). Analysis was performed by GC/MS.	50	n.d.
鄰苯二甲酸二丁酯 / DBP (Dibutyl phthalate) (CAS No.: 84-74-2)	mg/kg	參考IEC 62321-8 (111/321/CD), 以氣 相層析儀/質譜儀檢測之。 / With reference to IEC 62321-8 (111/321/CD). Analysis was performed by GC/MS.	50	n.d.

This document is issued by the Company subject to its General Conditions of Service printed overleaf, available on request or accessible at <http://www.sgs.com/en/Terms-and-Conditions.aspx> and, for electronic format documents, subject to Terms and Conditions for Electronic Documents at <http://www.sgs.com/en/Terms-and-Conditions/Termse-Documents.aspx>. Attention is drawn to the limitation of liability, indemnification and jurisdiction issues defined therein. Any holder of this document is advised that information contained hereon reflects the Company's findings at the time of its intervention only and within the limits of client's instruction, if any. The Company's sole responsibility is to its Client and this document does not exonerate parties to a transaction from exercising all their rights and obligations under the transaction documents. This document cannot be reproduced, except in full, without prior written approval of the Company. Any unauthorized alteration, forgery or falsification of the content or appearance of this document is unlawful and offenders may be prosecuted to the fullest extent of the law. Unless otherwise stated the results shown in this test report refer only to the sample(s) tested.

測試報告

Test Report

號碼(No.) : CE/2015/53008

日期(Date) : 2015/05/20

頁數(Page): 3 of 11

喬越實業有限公司

SIL-MORE INDUSTRIAL LTD.

新北市三重區興德路100號16樓

16F, NO. 100, XINGDE RD., SANCHONG DISTRICT, NEW TAIPEI CITY 24158, TAIWAN



測試項目 (Test Items)	單位 (Unit)	測試方法 (Method)	方法偵測 極限值 (MDL)	結果 (Result)
				No.1
鄰苯二甲酸丁苯甲酯 / BBP (Butyl Benzyl phthalate) (CAS No.: 85-68-7)	mg/kg	參考IEC 62321-8 (111/321/CD), 以氣相層析儀/質譜儀檢測之。 / With reference to IEC 62321-8 (111/321/CD). Analysis was performed by GC/MS.	50	n.d.
鄰苯二甲酸二(2-乙基己基)酯 / DEHP (Di-(2-ethylhexyl) phthalate) (CAS No.: 117-81-7)	mg/kg	參考IEC 62321-8 (111/321/CD), 以氣相層析儀/質譜儀檢測之。 / With reference to IEC 62321-8 (111/321/CD). Analysis was performed by GC/MS.	50	n.d.
鄰苯二甲酸二正辛酯 / DNOP (Di-n-octyl phthalate) (CAS No.: 117-84-0)	mg/kg	參考IEC 62321-8 (111/321/CD), 以氣相層析儀/質譜儀檢測之。 / With reference to IEC 62321-8 (111/321/CD). Analysis was performed by GC/MS.	50	n.d.
鄰苯二甲酸二異壬酯 / DINP (Di-isononyl phthalate) (CAS No.: 28553-12-0; 68515-48-0)	mg/kg	參考IEC 62321-8 (111/321/CD), 以氣相層析儀/質譜儀檢測之。 / With reference to IEC 62321-8 (111/321/CD). Analysis was performed by GC/MS.	50	n.d.
鄰苯二甲酸二異癸酯 / DIDP (Di-isodecyl phthalate) (CAS No.: 26761-40-0; 68515-49-1)	mg/kg	參考IEC 62321-8 (111/321/CD), 以氣相層析儀/質譜儀檢測之。 / With reference to IEC 62321-8 (111/321/CD). Analysis was performed by GC/MS.	50	n.d.
鄰苯二甲酸二戊酯 / Di-n-pentyl phthalate (CAS No.: 131-18-0)	mg/kg	參考IEC 62321-8 (111/321/CD), 以氣相層析儀/質譜儀檢測之。 / With reference to IEC 62321-8 (111/321/CD). Analysis was performed by GC/MS.	50	n.d.

This document is issued by the Company subject to its General Conditions of Service printed overleaf, available on request or accessible at <http://www.sgs.com/en/Terms-and-Conditions.aspx> and, for electronic format documents, subject to Terms and Conditions for Electronic Documents at <http://www.sgs.com/en/Terms-and-Conditions/Termse-Documents.aspx>. Attention is drawn to the limitation of liability, indemnification and jurisdiction issues defined therein. Any holder of this document is advised that information contained hereon reflects the Company's findings at the time of its intervention only and within the limits of client's instruction, if any. The Company's sole responsibility is to its Client and this document does not exonerate parties to a transaction from exercising all their rights and obligations under the transaction documents. This document cannot be reproduced, except in full, without prior written approval of the Company. Any unauthorized alteration, forgery or falsification of the content or appearance of this document is unlawful and offenders may be prosecuted to the fullest extent of the law. Unless otherwise stated the results shown in this test report refer only to the sample(s) tested.

測試報告 Test Report

號碼(No.) : CE/2015/53008

日期(Date) : 2015/05/20

頁數(Page): 4 of 11

喬越實業有限公司

SIL-MORE INDUSTRIAL LTD.

新北市三重區興德路100號16樓

16F, NO. 100, XINGDE RD., SANCHONG DISTRICT, NEW TAIPEI CITY 24158, TAIWAN



測試項目 (Test Items)	單位 (Unit)	測試方法 (Method)	方法偵測 極限值 (MDL)	結果 (Result)
				No.1
六溴環十二烷及所有主要被辨別出的異構物 / Hexabromocyclododecane (HBCDD) and all major diastereoisomers identified (α - HBCDD, β - HBCDD, γ - HBCDD) (CAS No.: 25637-99-4 and 3194-55-6 (134237-51-7, 134237-50-6, 134237-52-8))	mg/kg	參考IEC 62321: 2008方法, 以氣相層析/質譜儀檢測. / With reference to IEC 62321: 2008 method. Analysis was performed by GC/MS.	5	n.d.
多溴聯苯總和 / Sum of PBBs	mg/kg	參考IEC 62321: 2008方法, 以氣相層析/質譜儀檢測. / With reference to IEC 62321: 2008 and performed by GC/MS.	-	n.d.
一溴聯苯 / Monobromobiphenyl	mg/kg		5	n.d.
二溴聯苯 / Dibromobiphenyl	mg/kg		5	n.d.
三溴聯苯 / Tribromobiphenyl	mg/kg		5	n.d.
四溴聯苯 / Tetrabromobiphenyl	mg/kg		5	n.d.
五溴聯苯 / Pentabromobiphenyl	mg/kg		5	n.d.
六溴聯苯 / Hexabromobiphenyl	mg/kg		5	n.d.
七溴聯苯 / Heptabromobiphenyl	mg/kg		5	n.d.
八溴聯苯 / Octabromobiphenyl	mg/kg		5	n.d.
九溴聯苯 / Nonabromobiphenyl	mg/kg		5	n.d.
十溴聯苯 / Decabromobiphenyl	mg/kg		5	n.d.
多溴聯苯醚總和 / Sum of PBDEs	mg/kg		-	n.d.
一溴聯苯醚 / Monobromodiphenyl ether	mg/kg		5	n.d.
二溴聯苯醚 / Dibromodiphenyl ether	mg/kg		5	n.d.
三溴聯苯醚 / Tribromodiphenyl ether	mg/kg		5	n.d.
四溴聯苯醚 / Tetrabromodiphenyl ether	mg/kg		5	n.d.
五溴聯苯醚 / Pentabromodiphenyl ether	mg/kg		5	n.d.
六溴聯苯醚 / Hexabromodiphenyl ether	mg/kg		5	n.d.
七溴聯苯醚 / Heptabromodiphenyl ether	mg/kg		5	n.d.
八溴聯苯醚 / Octabromodiphenyl ether	mg/kg		5	n.d.
九溴聯苯醚 / Nonabromodiphenyl ether	mg/kg	5	n.d.	
十溴聯苯醚 / Decabromodiphenyl ether	mg/kg	5	n.d.	

This document is issued by the Company subject to its General Conditions of Service printed overleaf, available on request or accessible at <http://www.sgs.com/en/Terms-and-Conditions.aspx> and, for electronic format documents, subject to Terms and Conditions for Electronic Documents at <http://www.sgs.com/en/Terms-and-Conditions/Termse-Document.aspx>. Attention is drawn to the limitation of liability, indemnification and jurisdiction issues defined therein. Any holder of this document is advised that information contained hereon reflects the Company's findings at the time of its intervention only and within the limits of client's instruction, if any. The Company's sole responsibility is to its Client and this document does not exonerate parties to a transaction from exercising all their rights and obligations under the transaction documents. This document cannot be reproduced, except in full, without prior written approval of the Company. Any unauthorized alteration, forgery or falsification of the content or appearance of this document is unlawful and offenders may be prosecuted to the fullest extent of the law. Unless otherwise stated the results shown in this test report refer only to the sample(s) tested.

測試報告

Test Report

號碼(No.) : CE/2015/53008

日期(Date) : 2015/05/20

頁數(Page): 5 of 11

喬越實業有限公司

SIL-MORE INDUSTRIAL LTD.

新北市三重區興德路100號16樓

16F, NO. 100, XINGDE RD., SANCHONG DISTRICT, NEW TAIPEI CITY 24158, TAIWAN



測試項目 (Test Items)	單位 (Unit)	測試方法 (Method)	方法偵測 極限值 (MDL)	結果 (Result)
				No.1
鹵素 / Halogen				
鹵素 (氟) / Halogen-Fluorine (F) (CAS No.: 14762-94-8)	mg/kg	參考BS EN 14582:2007, 以離子層析儀 分析. / With reference to BS EN 14582:2007. Analysis was performed by IC.	50	n.d.
鹵素 (氯) / Halogen-Chlorine (Cl) (CAS No.: 22537-15-1)	mg/kg		50	n.d.
鹵素 (溴) / Halogen-Bromine (Br) (CAS No.: 10097-32-2)	mg/kg		50	n.d.
鹵素 (碘) / Halogen-Iodine (I) (CAS No.: 14362-44-8)	mg/kg		50	n.d.

備註(Note) :

1. mg/kg = ppm ; 0.1wt% = 1000ppm
2. n.d. = Not Detected (未檢出)
3. MDL = Method Detection Limit (方法偵測極限值)
4. "-" = Not Regulated (無規格值)

測試報告 Test Report

號碼(No.) : CE/2015/53008

日期(Date) : 2015/05/20

頁數(Page): 6 of 11

喬越實業有限公司

SIL-MORE INDUSTRIAL LTD.

新北市三重區興德路100號16樓

16F, NO. 100, XINGDE RD., SANCHONG DISTRICT, NEW TAIPEI CITY 24158, TAIWAN



- 1) 根據以下的流程圖之條件，樣品已完全溶解。(六價鉻測試方法除外) / These samples were dissolved totally by pre-conditioning method according to below flow chart. (Cr⁶⁺ test method excluded)
- 2) 測試人員：楊登偉 / Name of the person who made measurement: Climbgreat Yang
- 3) 測試負責人：張啓興 / Name of the person in charge of measurement: Troy Chang

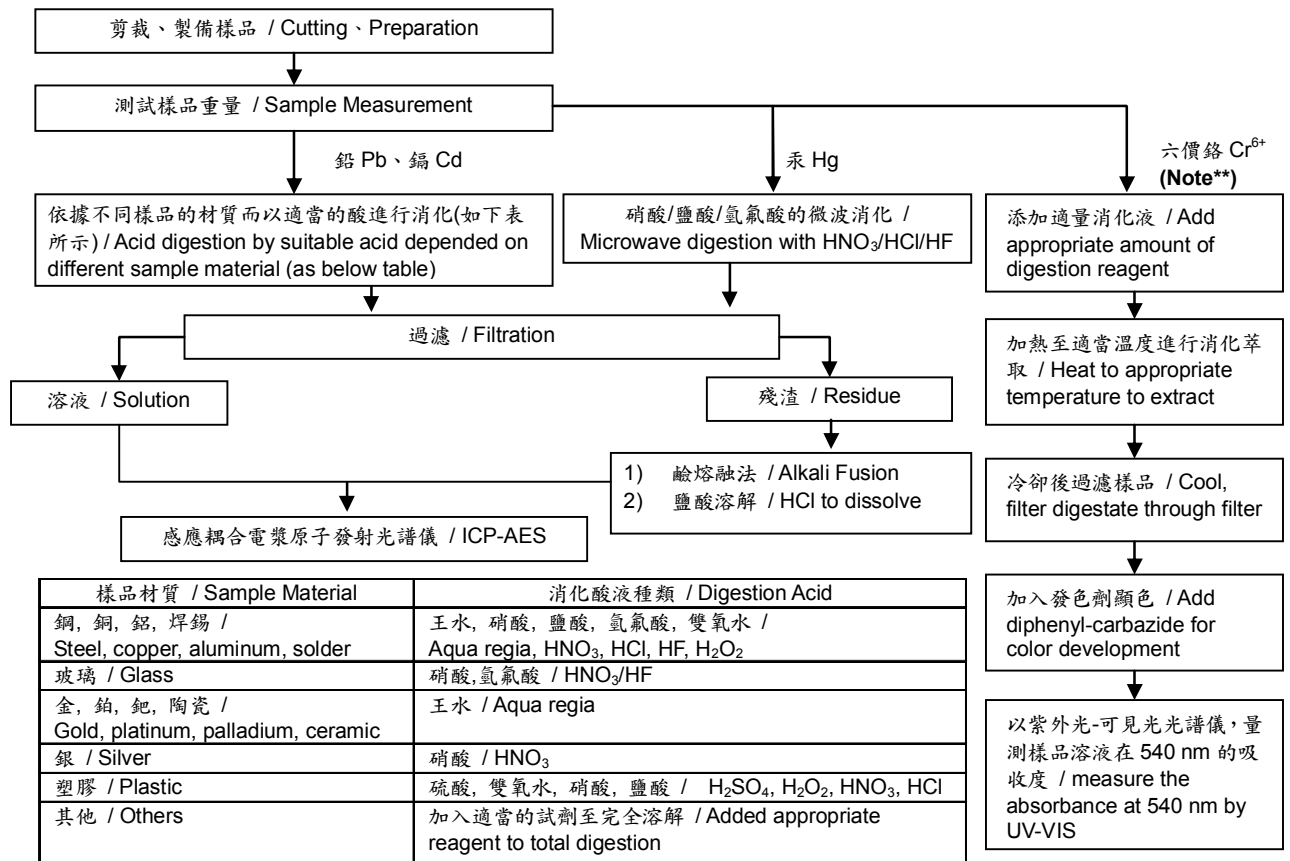

Note (For IEC 62321)**

- (1) 針對非金屬材料加入鹼性消化液，加熱至 90~95°C 萃取。 / For non-metallic material, add alkaline digestion reagent and heat to 90~95°C.
- (2) 針對金屬材料加入純水，加熱至沸騰萃取。 / For metallic material, add pure water and heat to boiling.

測試報告 Test Report

號碼(No.) : CE/2015/53008

日期(Date) : 2015/05/20

頁數(Page): 7 of 11

喬越實業有限公司

SIL-MORE INDUSTRIAL LTD.

新北市三重區興德路100號16樓

16F, NO. 100, XINGDE RD., SANCHONG DISTRICT, NEW TAIPEI CITY 24158, TAIWAN



鹵素分析流程圖 / Analytical flow chart of halogen content

- 測試人員：陳恩臻 / Name of the person who made measurement: Rita Chen
- 測試負責人：張啓興 / Name of the person in charge of measurement: Troy Chang

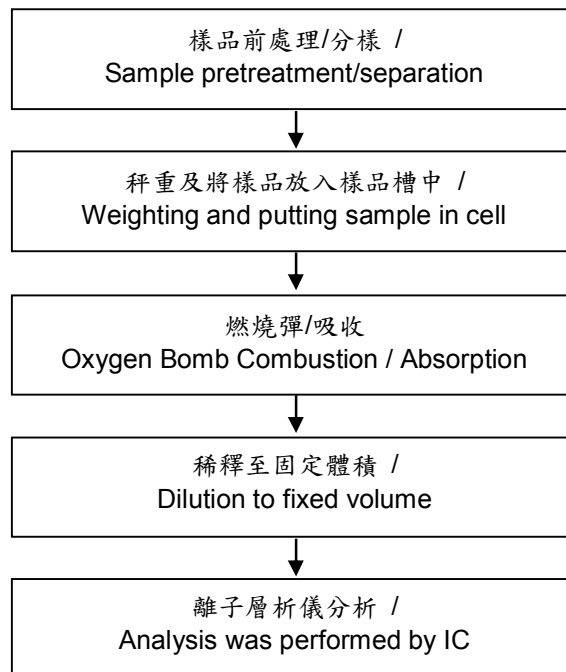

測試報告 Test Report

號碼(No.) : CE/2015/53008

日期(Date) : 2015/05/20

頁數(Page): 8 of 11

喬越實業有限公司

SIL-MORE INDUSTRIAL LTD.

新北市三重區興德路100號16樓

16F, NO. 100, XINGDE RD., SANCHONG DISTRICT, NEW TAIPEI CITY 24158, TAIWAN



六溴環十二烷分析流程圖 / HBCDD analytical flow chart

- 測試人員：翁賜彬 / Name of the person who made measurement: Roman Wong
- 測試負責人：張啓興 / Name of the person in charge of measurement: Troy Chang

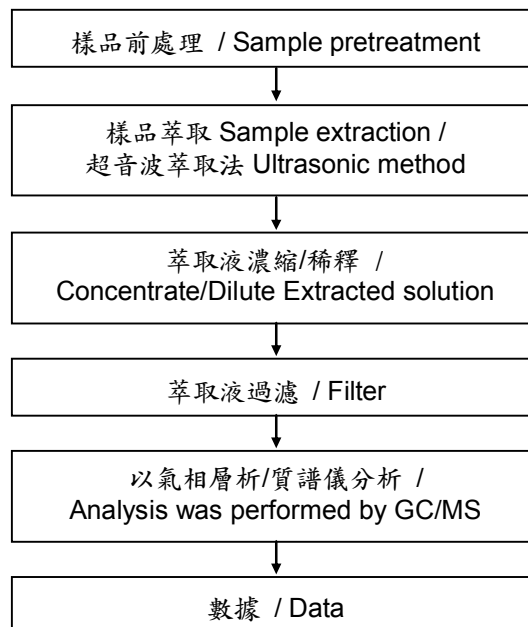

測試報告 Test Report

號碼(No.) : CE/2015/53008

日期(Date) : 2015/05/20

頁數(Page): 9 of 11

喬越實業有限公司

SIL-MORE INDUSTRIAL LTD.

新北市三重區興德路100號16樓

16F, NO. 100, XINGDE RD., SANCHONG DISTRICT, NEW TAIPEI CITY 24158, TAIWAN



可塑劑分析流程圖 / Analytical flow chart of phthalate content

- 測試人員：徐毓明 / Name of the person who made measurement: Andy Shu
- 測試負責人：張啓興 / Name of the person in charge of measurement: Troy Chang

【測試方法/Test method: IEC 62321-8】

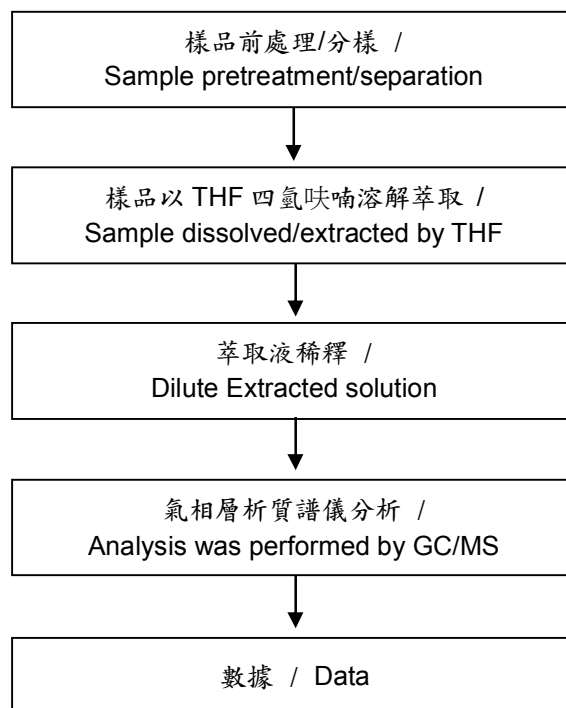

測試報告 Test Report

號碼(No.) : CE/2015/53008

日期(Date) : 2015/05/20

頁數(Page): 10 of 11

喬越實業有限公司

SIL-MORE INDUSTRIAL LTD.

新北市三重區興德路100號16樓

16F, NO. 100, XINGDE RD., SANCHONG DISTRICT, NEW TAIPEI CITY 24158, TAIWAN



多溴聯苯/多溴聯苯醚分析流程圖 / PBB/PBDE analytical FLOW CHART

- 測試人員：翁賜彬 / Name of the person who made measurement: Roman Wong
- 測試負責人：張啓興 / Name of the person in charge of measurement: Troy Chang

初次測試程序 / First testing process —————>

選擇性篩檢程序 / Optional screen process>

確認程序 / Confirmation process - - ->

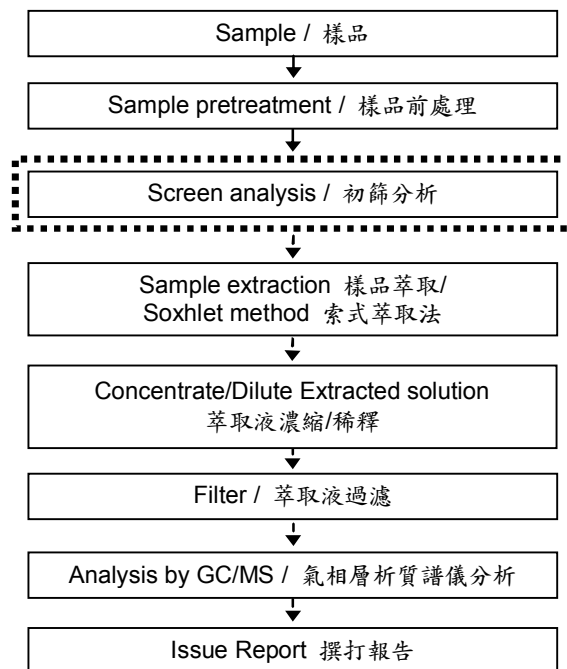

This document is issued by the Company subject to its General Conditions of Service printed overleaf, available on request or accessible at <http://www.sgs.com/en/Terms-and-Conditions.aspx> and, for electronic format documents, subject to Terms and Conditions for Electronic Documents at <http://www.sgs.com/en/Terms-and-Conditions/Termse-Documents.aspx>. Attention is drawn to the limitation of liability, indemnification and jurisdiction issues defined therein. Any holder of this document is advised that information contained hereon reflects the Company's findings at the time of its intervention only and within the limits of client's instruction, if any. The Company's sole responsibility is to its Client and this document does not exonerate parties to a transaction from exercising all their rights and obligations under the transaction documents. This document cannot be reproduced, except in full, without prior written approval of the Company. Any unauthorized alteration, forgery or falsification of the content or appearance of this document is unlawful and offenders may be prosecuted to the fullest extent of the law. Unless otherwise stated the results shown in this test report refer only to the sample(s) tested.

測試報告 Test Report

號碼(No.) : CE/2015/53008

日期(Date) : 2015/05/20

頁數(Page): 11 of 11

喬越實業有限公司

SIL-MORE INDUSTRIAL LTD.

新北市三重區興德路100號16樓

16F, NO. 100, XINGDE RD., SANCHONG DISTRICT, NEW TAIPEI CITY 24158, TAIWAN



* 照片中如有箭頭標示，則表示為實際檢測之樣品/部位。*

(The tested sample / part is marked by an arrow if it's shown on the photo.)

CE/2015/53008



** 報告結尾 (End of Report) **