

SPECIFICATION

Part No. : AP.10H.01

Product Name : 10mm SMT 25dB Active GPS/GALILEO Patch Antenna
With Front End Saw Filter

Features : Unique SMT GPS/GALILEO active patch
Wide Input Voltage 1.8V to 5.5V
Ultra low power consumption
RoHS compliant

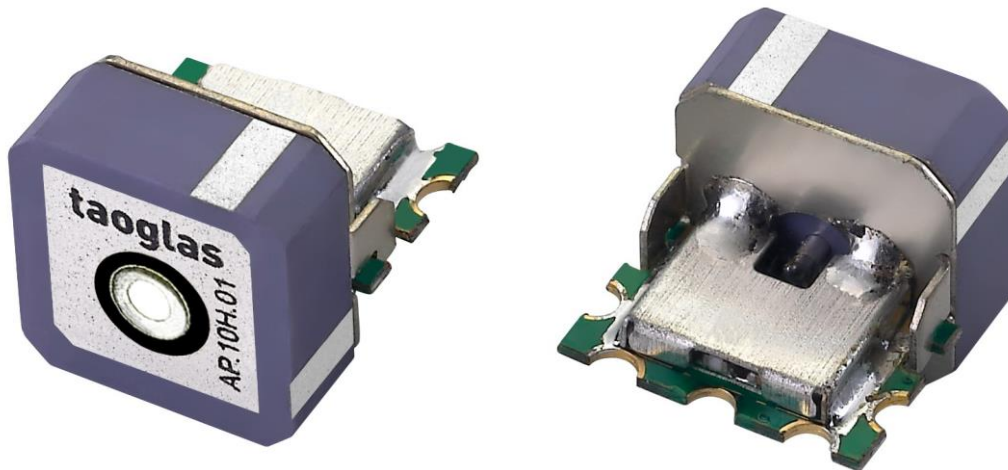

1. Introduction

The AP.10H.01 two stage 25dB active GPS patch antenna is the smallest SMT GPS high performance embedded antenna currently available in the world. Using extremely sensitive high dielectric constant powder formulation and tight process control the 10mm x 10mm x 4mm patch antenna is accurately tuned to have its frequency band right at 1575.42MHz for GPS/GALILEO systems.

A patented SMT structure gives high reliability in integration. With an ultra low power consumption two stage LNA with Saw Filter, this small active patch has the performance of an ordinary active patch, but at only a quarter of the size. This product is suited to small form factor mobile devices such as GPS/GALILEO Smartphones, Personal Location, Medical devices, Telematic devices and Automotive navigation and tracking. Custom gain, connector and cable versions are available.

The AP.10H consists of 2 functional blocks – the LNA and also the patch antenna.

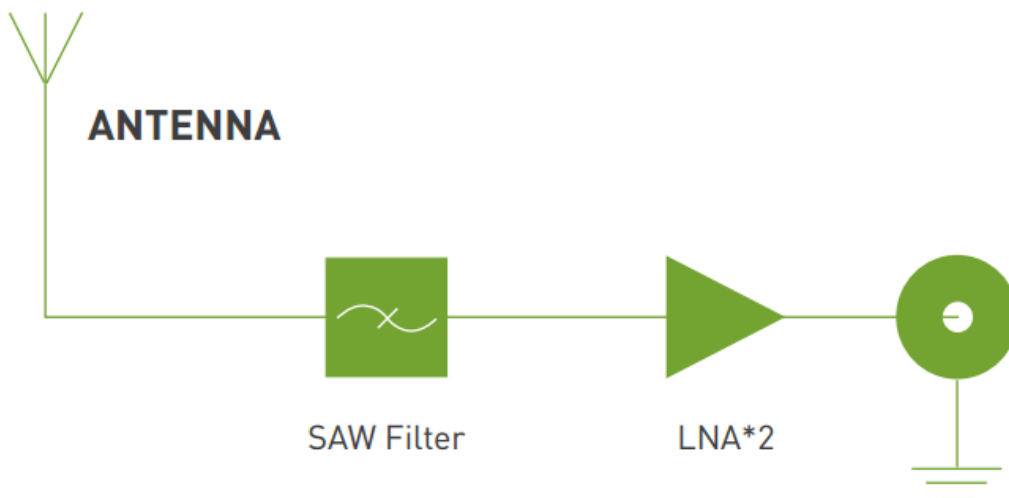

2. Specification

ELECTRICAL			
Frequency	1575.42 ± 1.023MHz		
Gain	Typ. -10dBic @ Zenith		
Gain@3.0V (With LNA)	15 ± 4dBic @ 90°		
Impedance	50Ω		
Polarization	RHCP		
Axial Ratio	Max 4.0dB @ Zenith		
Input Voltage	Min. 1.8V, Typ. 3.0V, Max. 5.5V		
ESD Capability	Direct Discharge: 4KV Min.		
LNA			
Frequency	1575.42 ± 1.023MHz		
Outer Band Attenuation	F0=1575.42MHz		
	F0±30MHz	5dB min.	
	F0±50MHz	20dB min.	
	F0±100MHz	25dB min.	
Output Impedance	50Ω		
Output VSWR	2.0 Max		
Pout at 1dB Gain	Min. 8dBm		
Compression point	Typ. 11dBm		
LNA Gain, Power Consumption and Noise Figure			
	LNA Gain(Typ)	Power Consumption(mA)Typ	Noise Figure(Typ)
Minimum 1.8V	20dB	5mA	2.7dB
Typical 3.0V	25dB	10mA	2.5dB
Maximum 5.5V	25dB	23mA	2.7dB
Input Voltage	Min. 1.8V	Typ. 3.0V	Max. 5.5V
MECHANICAL			
Dimension	10mm x 10mm x 4mm (add 7.3mm depth for vertical PCB)		
Connection	SMT via solder pads		
ENVIRONMENTAL			
Operation Temperature	-40°C to + 85°C		
Storage Temperature	-40°C to + 85°C		
Relative Humidity	40% to 95%		

3. LNA Gain and Out Band Rejection @3.0V



Cg1	Tr1	S21	>1	1.5754200 GHz	27.754 dB
Cg1	Tr1	S21	2	1.6054200 GHz	- 2.2291 dB
Cg1	Tr1	S21	3	1.5454200 GHz	20.458 dB
Cg1	Tr1	S21	4	1.6254200 GHz	- 32.691 dB
Cg1	Tr1	S21	5	1.5254200 GHz	- 10.283 dB
Cg1	Tr1	S21	6	1.6754200 GHz	- 23.132 dB
Cg1	Tr1	S21	7	1.4754200 GHz	- 21.485 dB

4. LNA Noise Figure @3.0V

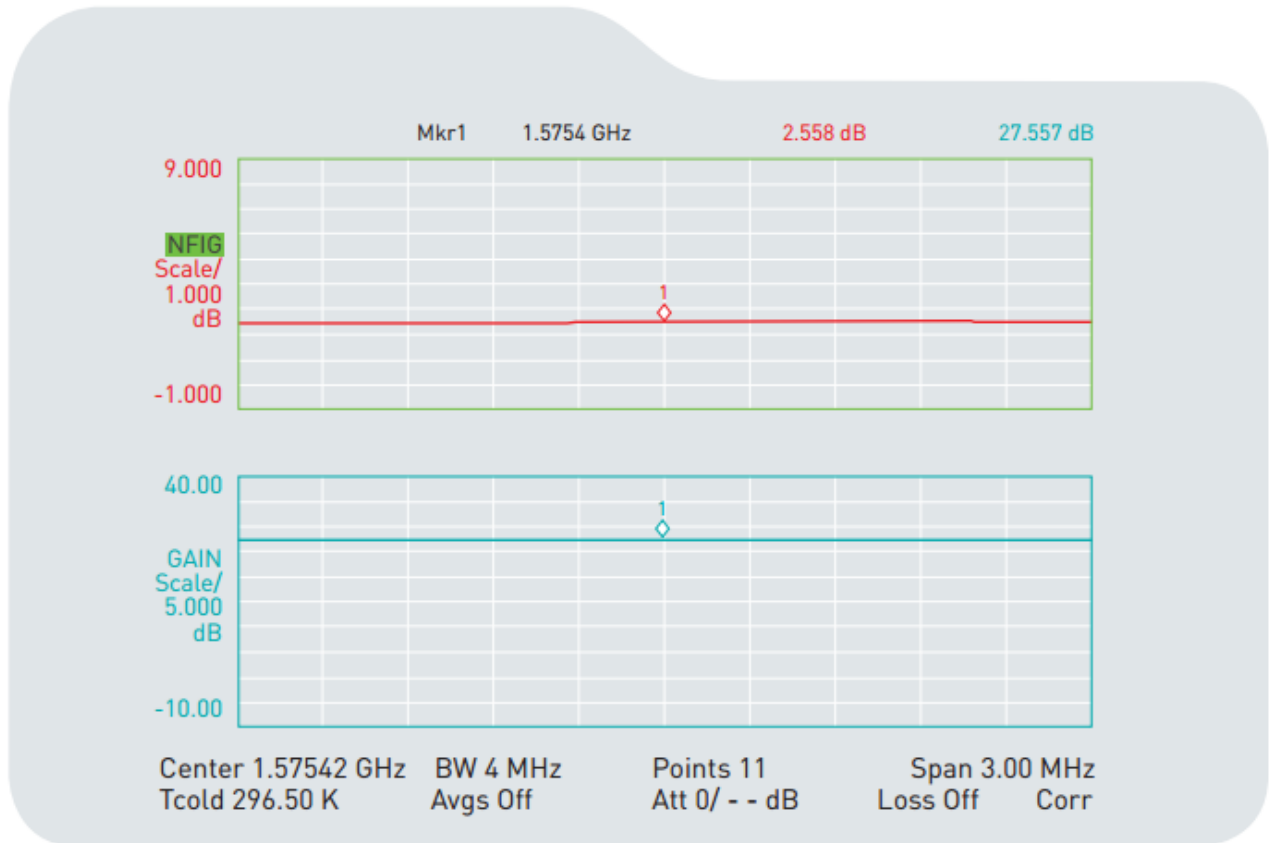

5. Radiation Patterns

XY Plane

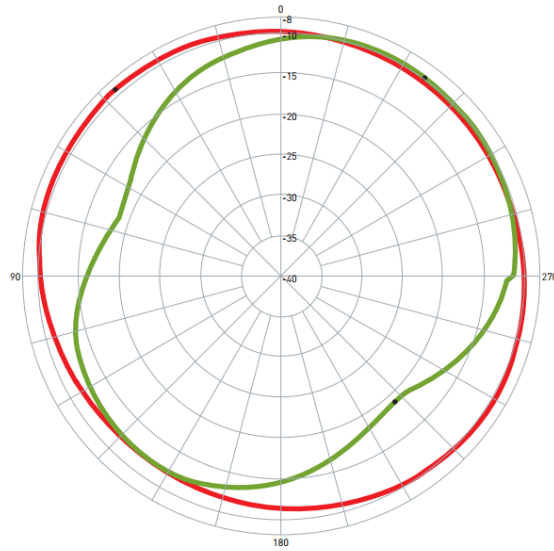

Pattern	Model No.	Test Mode	Freq [MHz]	Max Gain[dBi]	Min Gain[dBi]	Avg. Gain[dBi]	Source Polar.	Date
1	AP.10H.01	XZ	1620.00	-9.20 / 42.00	-11.99 / 147.00	-10.24	RHCP	2010/4/29
2	AP.10H.01	YZ	1620.00	-9.73 / 324.00	-19.18 / 222.00	-12.80	RHCP	2010/4/29

XZ Plane

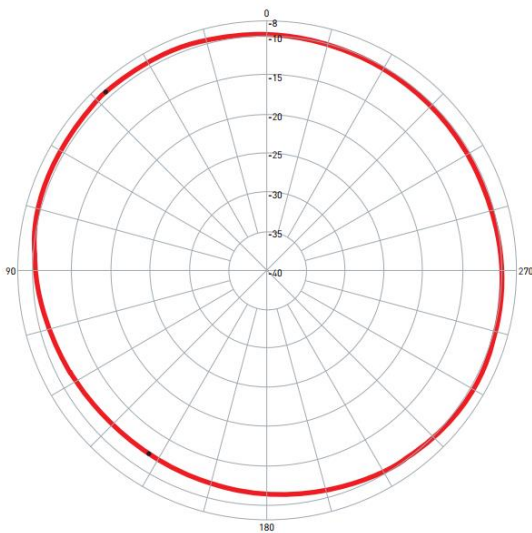

Pattern	Model No.	Test Mode	Freq [MHz]	Max Gain[dBi]	Min Gain[dBi]	Avg. Gain[dBi]	Source Polar.	Date
1	AP.10H.01	XZ	1620.00	-9.20 / 42.00	-11.99 / 147.00	-10.24	RHCP	2010/4/29

YZ Plane

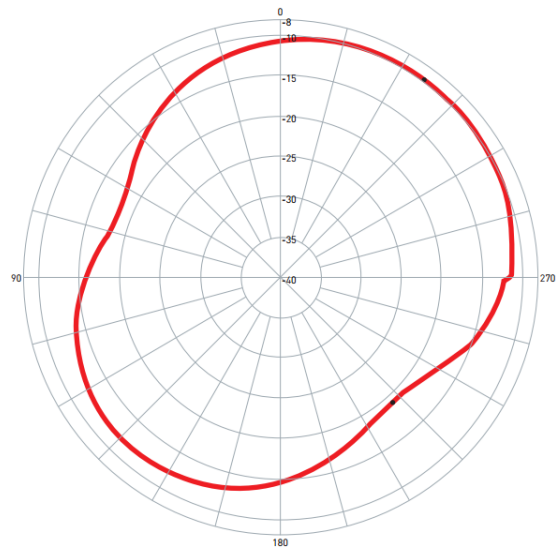



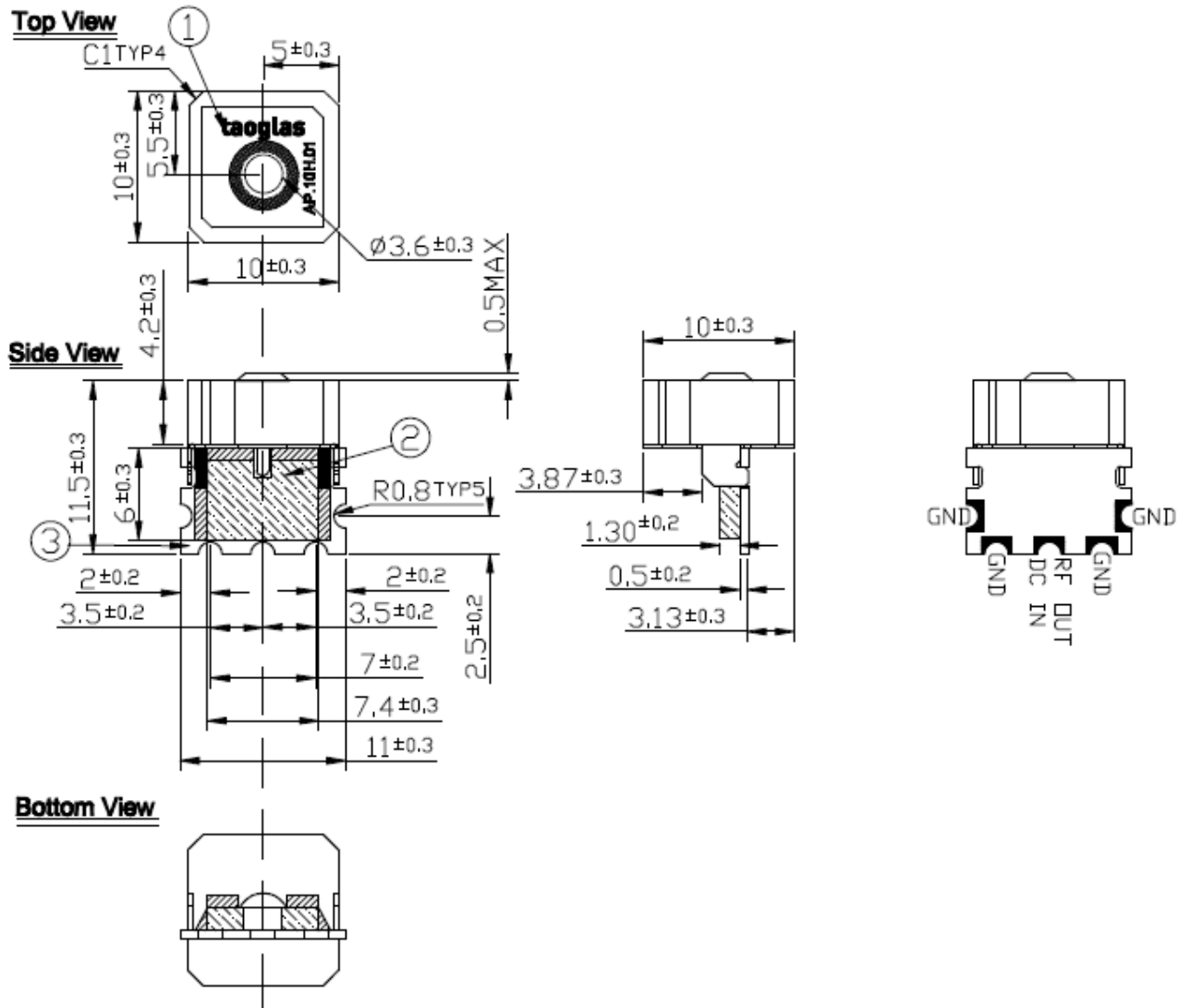

Pattern	Model No.	Test Mode	Freq [MHz]	Max Gain[dBi]	Min Gain[dBi]	Avg. Gain[dBi]	Source Polar.	Date
1	AP.10H.01	YZ	1620.00	-9.73 / 324.00	-19.18 / 222.00	-12.80	RHCP	2010/4/29

6. Technical Drawing



	Name	P/N	Material	Finish	QTY
1	Patch (10mm x 10mm x 4.2mm)	AP.10H	Ceramic	Clear	1
2	Shielding Case		Tin (SPTE)	Tin Plated	1
3	PCB		FR4 0.6t	Green	1

NOTE:

	1. Soldered area
	2. Solder Mask Area (Green)
	3. Clearance Area
	4. Shielding Case Area
	5. Area to be solder (Pad)

6.1. PCB Footprint

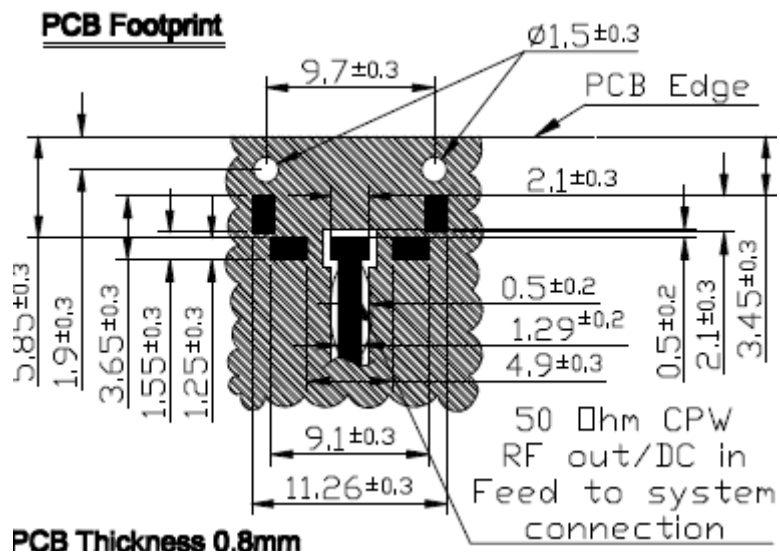

Application Assembly

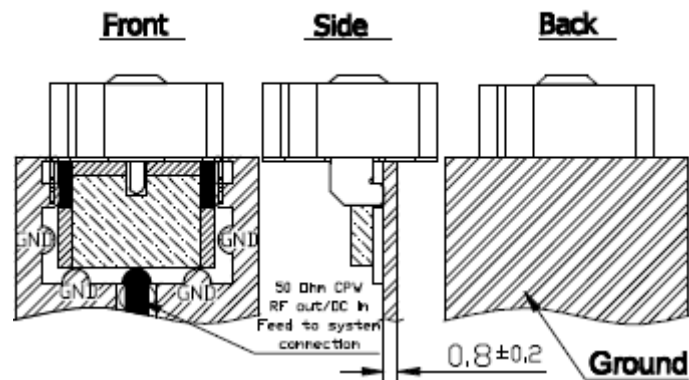

Name	P/N	Material	Finish	QTY	NOTE:
1 Patch (10mm x 10mm x 4.2mm)	AP.10H	Ceramic	Clear	1	 1. Soldered area
2 Shielding Case		Tin (SPTE)	Tin Plated	1	 2. Solder Mask Area (Green)
3 PCB		FR4 0.6t	Green	1	 3. Clearance Area
					 4. Shielding Case Area
					 5. Area to be solder (Pad)

7. Recommended Reflow Soldering Profile

AP.10H can be assembled following Pb-free assembly. According to the Standard IPC/JEDEC J-STD-020C, the temperature profile suggested is as follows:

Phase	Profile Features	Pb-Free Assembly (SnAgCu)
PREHEAT	Temperature Min(T_{smin}) Temperature Max(T_{smax}) Time(t_s) from (T_{smin} to T_{smax})	150°C 200°C 60-120 seconds
RAMP-UP	Avg. Ramp-up Rate (T_{smax} to TP)	3°C/second(max)
REFLOW	Temperature(TL) Total Time above TL (t_L)	217°C 30-100 seconds
PEAK	Temperature (TP) Time (t_p)	260°C 2-5 seconds
RAMP-DOWN	Rate	3°C/second(max)
Time from 25°C to Peak Temperature		8 minutes max.
Composition of solder paste		96.5Sn/3Ag/0.5Cu
Solder Paste Model		SHENMAO PF606-P26

The graphic shows temperature profile for component assembly process in reflow ovens

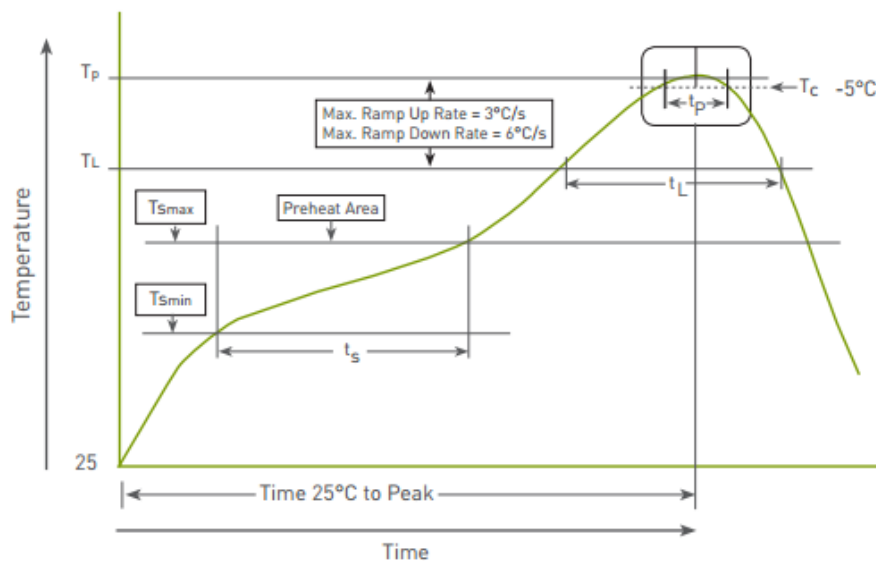

Soldering Iron condition: Soldering iron temperature $270^{\circ}\text{C} \pm 10^{\circ}\text{C}$.

Apply preheating at 120°C for 2-3 minutes. Finish soldering for each terminal within 3 seconds, if soldering iron temperature over $270^{\circ}\text{C} \pm 10^{\circ}\text{C}$ or 3 seconds, it will make cause component surface peeling or damage.

8. Packaging

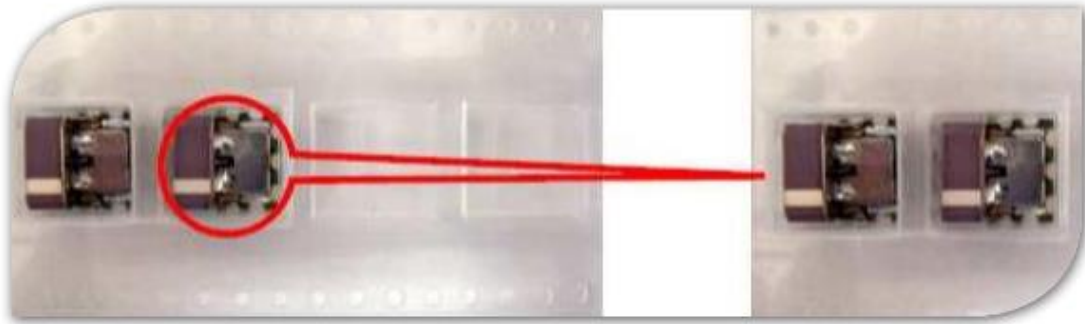

Packaged on Tape and Reel
Each Reel is packaged
Outer Carton contains 5 Reels

250 pieces per reel
Inner Carton
1250 pieces per Carton

Taoglas makes no warranties based on the accuracy or completeness of the contents of this document and reserves the right to make changes to specifications and product descriptions at any time without notice. Taoglas reserves all rights to this document and the information contained herein.

Reproduction, use or disclosure to third parties without express permission is strictly prohibited.

Copyright © Taoglas Ltd.