

Features

Regulated Converter

- Sixteenth brick format
- 4:1 input voltage range
- 2.25kV basic isolation
- Remote ON/OFF and trim pins
- UVLO, OTP, OVP, OCP and SCP
- Efficiency up to 91%



RPA50S-W

50Watt
1/16 Brick
Single Output



UL60950-1 certified
 IEC/EN60950-1 certified

Description

The RPA50S is a low cost 50W DC/DC converter in industry standard 1/16th brick format (33mm x 23mm) and pinning. The 4:1 input range covers 24V, 28V or 48V nominal input voltages and the output voltage options are 3.3V, 5V or 12V with +10%/-20% trim. Output power is 40W from 18-75V or 50W from 36-75V. The efficiency is particularly high (88-91%) to permit full load operation from -40°C up to +54°C ambient temperature with only free air convection and up to 85°C with forced air cooling. The isolation voltage is 2.25kVDC/1 minute (basic insulation grade). Applications include demanding industrial power supplies, telecom and PoE circuits.

Selection Guide

Part Number	nom. Input Voltage Range ⁽¹⁾ [VDC]	Output Voltage [VDC]	Output Current [A]	Efficiency max. ⁽¹⁾ [%]	Max. Capacitive typ. Load ⁽²⁾ [µF]
RPA50S-483.3SW/P	18-75	3.3	15	90.5	10000
RPA50S-4805SW/P	18-75	5	10	91	5000
RPA50S-4812SW/P	18-75	12	4.2	89	2200

Notes:

- Note1: Efficiency is tested at nominal input and full load at +25°C ambient
 Note2: Max. Cap Load is tested at nominal input and full resistive load

Model Numbering



Ordering Examples

RPA50S-4805SW/P = 48V Input, 5V Output, Single, Pos. CTRL function

Specifications (measured @ Ta = 25°C, nom. Vin, full load and after warm-up unless otherwise stated)

BASIC CHARACTERISTICS				
Parameter	Condition	Min.	Typ.	Max.
Internal Input Filter				Pi-Type
Input Voltage Range	nom. Vin = 48V	18VDC	48VDC	75VDC
Input Surge Voltage	100ms			100VDC
Under Voltage Lockout (UVLO)	DC-DC ON	16VDC	17VDC	18VDC
	DC-DC OFF	15VDC	16VDC	17VDC
Input Current Range	18Vin			3.9A
Quiescent Current	3.3Vout		30mA	
	5Vout		40mA	
	12Vout		20mA	

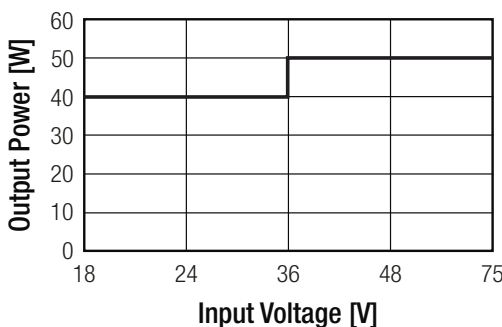

continued on next page

Specifications (measured @ Ta = 25°C, nom. Vin, full load and after warm-up unless otherwise stated)

BASIC CHARACTERISTICS

Parameter	Condition		Min.	Typ.	Max.
Output Voltage Trimming			-20%		+10%
Minimum Load			0%		
Start-up Time	Power up Remote ON/OFF			30ms 30ms	
ON/OFF CTRL	Positive Logic	3.3 & 5Vout	DC-DC ON DC-DC OFF	Open or 2.4V < Vr < 18V Short or 0V < Vr < 0.8V	
		12Vout	DC-DC ON DC-DC OFF	Open or 2V < Vr < 18V Short or 0V < Vr < 0.8V	
Input Current of CTRL pin					1mA
Standby Current					6.5mA
Internal Operating Frequency	3.3 & 5Vout 12Vout			580kHz 440kHz	
Output Ripple & Noise ⁽³⁾	5MHz to 20MHz BW.	3.3 & 5Vout		60mVp-p	
		12Vout		100mVp-p	150mVp-p
Remote Sense					10%

Notes:

Note3: measured with 1µF ceramic and 10µF tantalum in parallel across O/P

RPA50S-483.3SW/P

Efficiency vs. Output Load

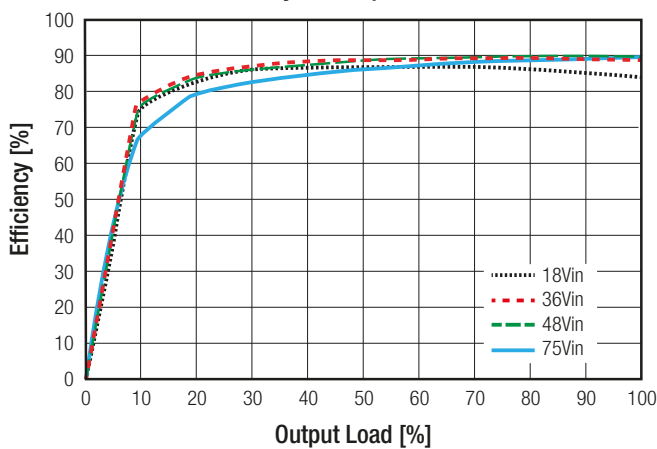

Power Dissipation vs. Output Load

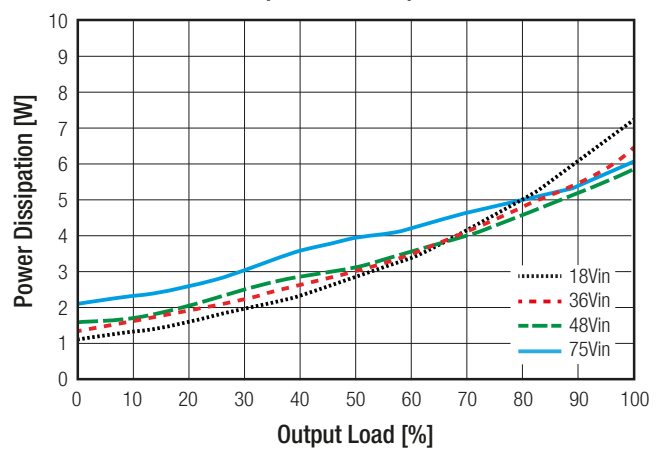

RPA50S-4805SW/P

Efficiency vs. Output Load

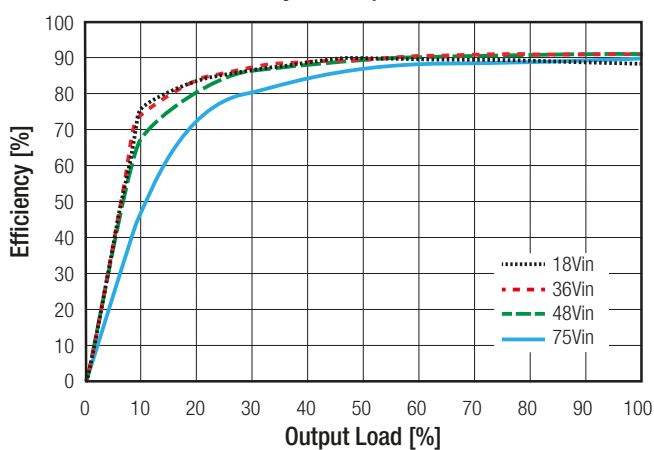

Power Dissipation vs. Output Load

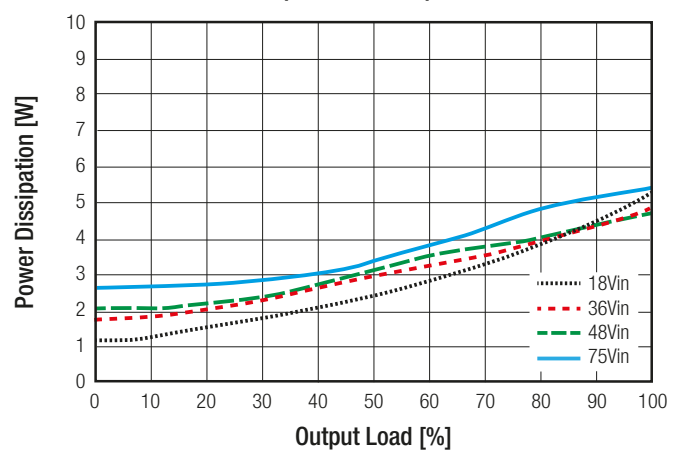

continued on next page

Specifications (measured @ Ta = 25°C, nom. Vin, full load and after warm-up unless otherwise stated)

RPA50S-4812SW/P

Efficiency vs. Output Load

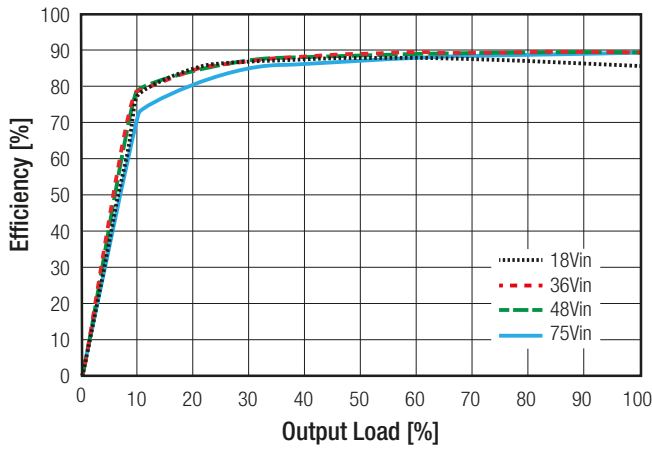

Power Dissipation vs. Output Load

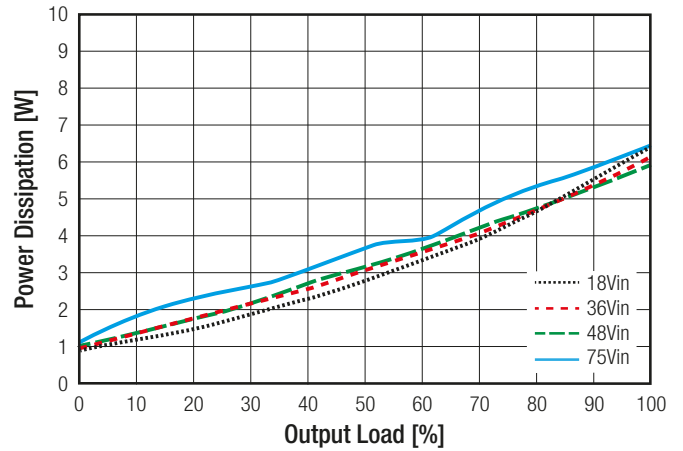

OUTPUT VOLTAGE TRIMMING

Output Voltage Trimming

RPA50S-W converters offer the feature of trimming the output voltage over a certain range around the nominal value by using external trim resistors. The values for trim resistors shown in trim tables below are according to standard E96 values; therefore, the specified voltage may slightly vary; they also can be calculated with below shown equation.

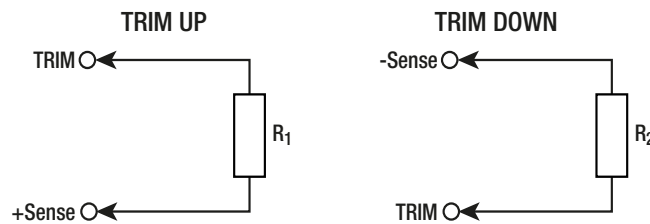

Trim Calculation

Trim Up:

3.3, 5 Vout

12Vout

$$R_1 = \frac{5.11 \cdot V_{out} \cdot (100 + \Delta V_{out})}{1.24 \cdot \Delta V_{out}} - \frac{511}{\Delta V_{out}} - 10.22 \text{ k}\Omega$$

$$R_1 = \frac{5.11 \cdot V_{out} \cdot (100 + \Delta V_{out})}{1.225 \cdot \Delta V_{out}} - \frac{511}{\Delta V_{out}} - 10.22 \text{ k}\Omega$$

Vout = Output Voltage

ΔV_{out} = Output Voltage Change in %

R1 = trim up resistor

R2 = trim down resistor

Trim Down:

$$R_2 = \frac{511}{\Delta V_{out}} - 10.22$$

Practical Example:

Trim Up:

Vout = 12V, ΔV_{out} = +10% (13.2V)

$$R_1 = \frac{5.11 \cdot 12 \cdot (100 + 10)}{1.24 \cdot 10} - \frac{511}{10} = \frac{6745.2}{12.24} - 51.1 - 10.22 = 489.3 \text{ k}\Omega$$

Trim down:

Vout = 12V, ΔV_{out} = -10% (10.8V)

$$R_2 = \frac{511}{10} - 10.22 = 40.88 \text{ k}\Omega$$

continued on next page

Specifications (measured @ Ta = 25°C, nom. Vin, full load and after warm-up unless otherwise stated)

RPA50S-483.3SW/P											
Trim up	1	2	3	4	5	6	7	8	9	10	%
Vout =	3.33	3.37	3.40	3.43	3.47	3.50	3.53	3.57	3.60	3.63	Volts
R ₁ =	845	432	287	215	174	143	124	110	97.60	88.7	kOhms

RPA50S-4805SW/P											
Trim up	1	2	3	4	5	6	7	8	9	10	%
Vout =	5.05	5.10	5.15	5.20	5.25	5.30	5.35	5.4	5.45	5.50	Volts
R ₁ =	1540	787	523	402	324	267	232	205	182	165	kOhms

RPA50S-4812SW/P											
Trim up	1	2	3	4	5	6	7	8	9	10	%
Vout =	12.12	12.24	12.36	12.48	12.60	12.72	12.84	12.96	13.08	13.20	Volts
R ₁ =	4530	2280	1540	1150	931	787	681	604	536	487	kOhms

Trim Down all Vout's											
Trim down	1	2	3	4	5	6	7	8	9	10	%
R ₂ =	499	243	162	118	93.1	75.0	63.4	53.6	46.4	41.2	kOhms
Trim down	11	12	13	14	15	16	17	18	19	20	%
R ₂ =	36.5	33.2	29.4	26.1	23.7	21.7	20.0	18.20	16.9	15.0	kOhms

REMOTE SENSE

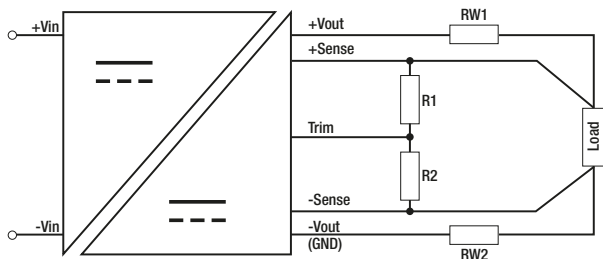

The output voltage can be adjusted by both trim and remote sense. The maximum combined adjustment range $\pm 10\%$. Derate the maximum output power if using the trim or sense function.

- R_{W1} ... wire losses +
- R_{W2} ... wire losses -
- R₁ ... trim up resistor
- R₂ ... trim down resistor

REGULATIONS

Parameter	Condition		Value
Output Accuracy			$\pm 3.0\%$
Line Regulation	3.3Vout 5 & 12Vout		$\pm 0.3\%$ max. $\pm 0.1\%$ max.
Load Regulation	0% - 100% load	3.3Vout 5Vout 12Vout	$\pm 0.3\%$ max. $\pm 0.2\%$ max. $\pm 0.1\%$ max.
Transient Response	3.3 & 5Vout	25% to 50% load step change 50% to 25% load step change recovery time	100mV typ. 100mV typ. 200 μ s typ.
	12Vout	25% to 50% load step change 50% to 25% load step change recovery time	400mV typ. 400mV typ. 500 μ s typ.

continued on next page

Specifications (measured @ Ta = 25°C, nom. Vin, full load and after warm-up unless otherwise stated)

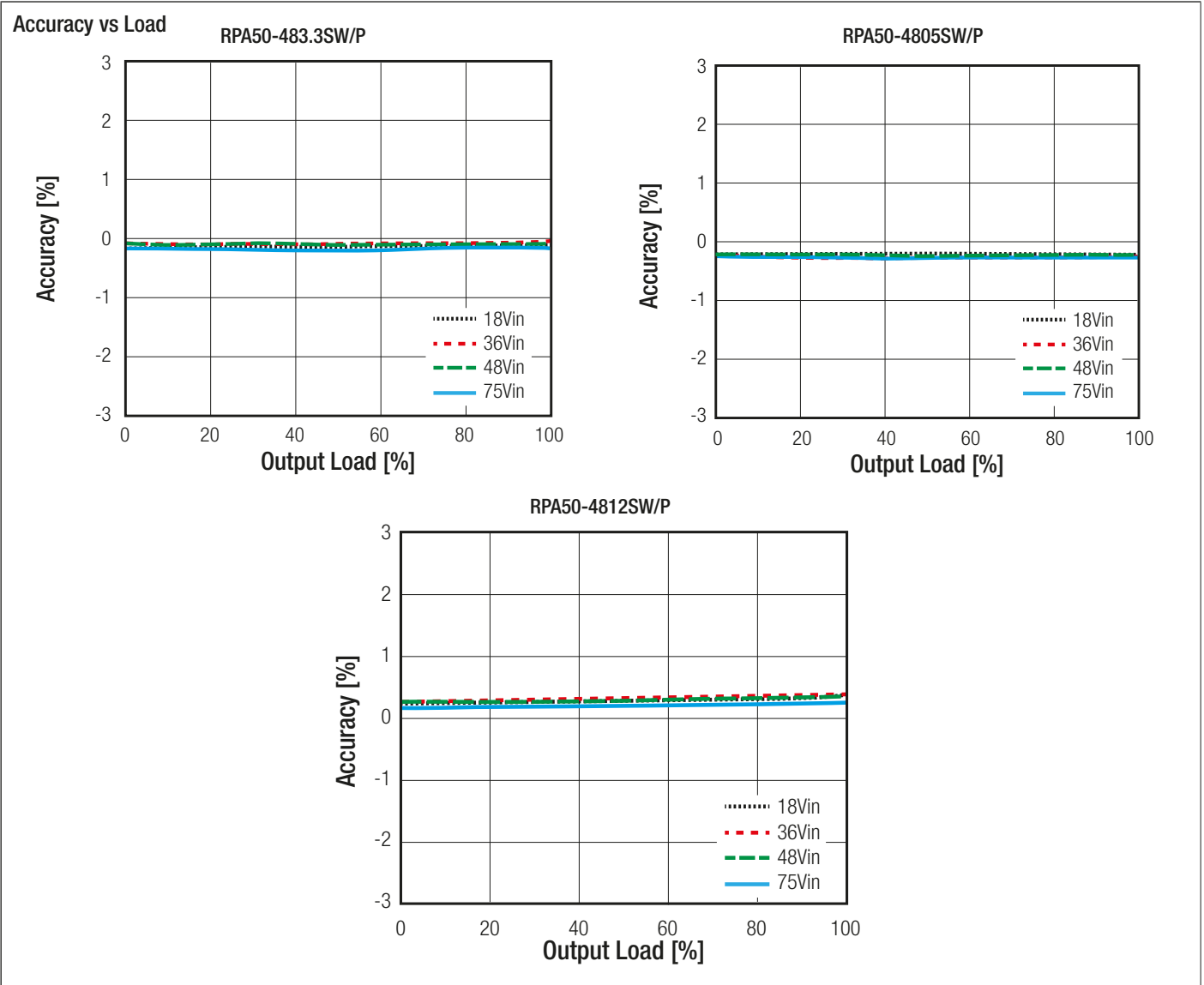

PROTECTIONS			
Parameter	Type		Value
Short Circuit Protection (SCP)	below 100mΩ		hiccup mode, auto recovery
Over Voltage Protection (OVP)	3.3 & 5Vout		115% - 140%, hiccup mode
	12Vout		120% - 150%, hiccup mode
Over Current Protection (OCP)			110% - 140%, hiccup mode
Over Temperature Protection (OTP)			130°C, hiccup mode
Isolation Voltage ⁽⁴⁾	I/P to O/P	rated for 1 minute	2.25kVDC
Isolation Resistance			10MΩ min.
Isolation Capacitance			1000pF typ.
Leakage Current			0.23mA max.
Insulation Grade			basic
Notes:			
Note4: For repeat Hi-Pot testing, reduce the time and/or the test voltage			
Note5: An input fuse is required if the mains supply is not over-current protected. Recommended fuse T10A slow blow type			

Specifications (measured @ Ta = 25°C, nom. Vin, full load and after warm-up unless otherwise stated)

ENVIRONMENTAL

Parameter	Condition	Value	
Operating Temperature Range	without derating (@ natural convection 0.1m/s, see graph)	-40°C to +54°C	
Over Temperature Shutdown	@ TC	+130°C typ.	
Temperature Coefficient		0.02%/°C	
Operating Altitude		5000m	
Operating Humidity	non-condensing	95% RH max.	
Pollution Degree		PD2	
MTBF	according to Telcordia SR332 Issue 2 Method I standard, 25°C	3.3Vout	2758 x 10 ³ hours
		5Vout	3757 x 10 ³ hours
		12Vout	10084 x 10 ³ hours

Thermal Calculation

Thermal Impedance	
airflow [m/s]	Rth with PCB [°C/W]
0.1	11.5
0.2	11.2
0.5	9.9
1.0	8.5
1.5	7.5

Notes:

Note6: Test PCB:160x100mm105µm (Eurocard), double layer

Example:

$$\begin{aligned}
 I_{out} &= 100\% \\
 R_{th} &= 9.9^{\circ}\text{C/W} \\
 P_{Diss} &= 6\text{W} \\
 T_{ICmax} &= 122^{\circ}\text{C}
 \end{aligned}$$

choose your model:

RPA50S-4812SW/P

- Load conditions in application (e.g. 100%)
- Airflow conditions in application (e.g. 0.5m/s)
- use Rth from above shown table (9.9°C/W)

$$T_{OVER} = R_{th} \times P_{Diss} = 9.9^{\circ}\text{C/W} \times 6\text{W} = 59.4^{\circ}\text{C}$$

$$T_{AMBmax} = T_{ICmax} - T_{OVER} = 122^{\circ}\text{C} - 59.4^{\circ}\text{C} = 63^{\circ}\text{C}$$

RPA50S-4812SW/P

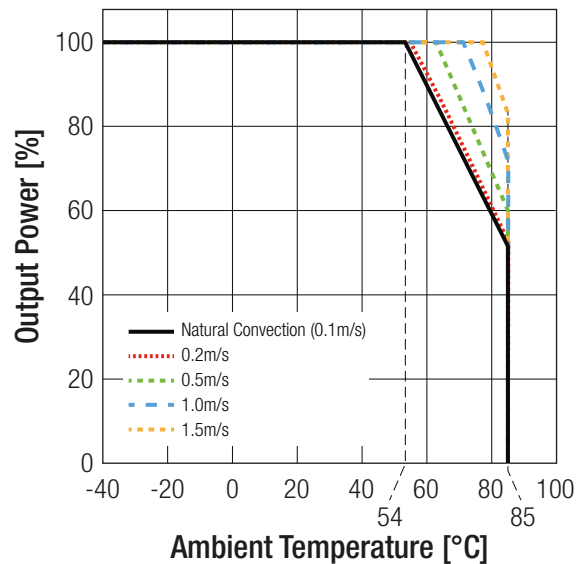

SAFETY AND CERTIFICATIONS

Certificate Type	Report / File Number	Standard
Information Technology Equipment, General Requirements for Safety	E224736-A44	UL60950-1 CAN/CSA C22.2 No. 60950-1-07
Information Technology Equipment, General Requirements for Safety	50089713 001	IEC60950-1, 2nd Edition, 2005 + AM2, 2013 EN60950-1, 1st Edition, 2006 + AM2, 2013
EAC	RU-AT.49.09571	TP TC 004/2011
RoHS 2+		RoHS 2011/65/EU

continued on next page

Specifications (measured @ Ta = 25°C, nom. Vin, full load and after warm-up unless otherwise stated)

SAFETY AND CERTIFICATIONS COMPLIANT

EMC Compliance	Conditions	Standard / Criterion
Electromagnetic compatibility of multimedia equipment - Emission requirements	with external filter	EN55032, Class B

EMC Filtering according to EN55032 Class B

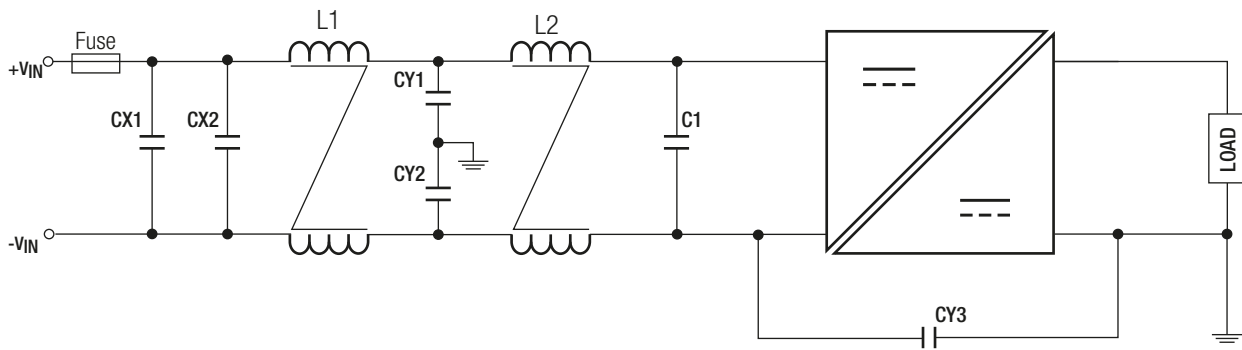

CX1	CX2	L1	CY1, CY2	L2	C1	CY3
1µF ceramic cap.	4.7µF ceramic cap.	0.2mH common mode inductor	4.7nF ceramic cap.	0.5mH common mode inductor	100µF low ESR aluminium cap.	10nF ceramic cap.

DIMENSION and PHYSICAL CHARACTERISTICS

Parameter	Type	Value
Material	base	FR4, (UL94 V-0)
Package Dimension (LxWxH)		33.0 x 22.8 x 9.5mm
Package Weight		12.1g typ.

Dimension Drawing (mm)

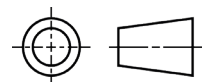
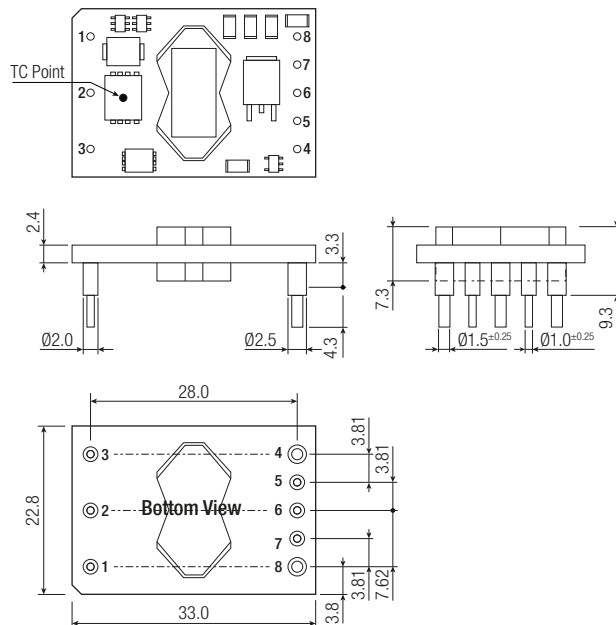

Pin Connections

Pin #	Single
1	+Vin
2	CTRL
3	-Vin
4	-Vout
5	-Sense
6	Trim
7	+Sense
8	+Vout

Tolerance: X.X ±0.5mm
X.XX ±0.25mm

Specifications (measured @ Ta = 25°C, nom. Vin, full load and after warm-up unless otherwise stated)

PACKAGING INFORMATION		
Parameter	Type	Value
Packaging Dimension (LxWxH)	card board box	221.0 x 128.0 x 33.0mm
Packaging Quantity		12pcs
Storage Temperature Range		-55°C to +125°C
Storage Humidity	non-condensing	95% RH max.

The product information and specifications may be subject to changes even without prior written notice. The product has been designed for various applications; its suitability lies in the responsibility of each customer. The products are not authorized for use in safety-critical applications without RECOM's explicit written consent. A safety-critical application is an application where a failure may reasonably be expected to endanger or cause loss of life, inflict bodily harm or damage property. The applicant shall indemnify and hold harmless RECOM, its affiliated companies and its representatives against any damage claims in connection with the unauthorized use of RECOM products in such safety-critical applications.