



Inductors for High Frequency Circuits

Multilayer Ceramic

MLG-P Series (For automobiles)

MLG0603P_{Type}

MLG0603P

0603 [0201 inch]*

* Dimensions Code JIS[EIA]

REMINDERS FOR USING THESE PRODUCTS

Before using these products, be sure to request the delivery specifications.

SAFETY REMINDERS

Please pay sufficient attention to the warnings for safe designing when using these products.

REMINDERS

- The storage period is less than 12 months. Be sure to follow the storage conditions (Temperature: 5 to 40°C, Humidity: 10 to 75% RH or less).
If the storage period elapses, the soldering of the terminal electrodes may deteriorate.
- Do not use or store in locations where there are conditions such as gas corrosion (salt, acid, alkali, etc.).
- Before soldering, be sure to preheat components.
The preheating temperature should be set so that the temperature difference between the solder temperature and chip temperature does not exceed 150°C.
- Soldering corrections after mounting should be within the range of the conditions determined in the specifications.
If overheated, a short circuit, performance deterioration, or lifespan shortening may occur.
- When embedding a printed circuit board where a chip is mounted to a set, be sure that residual stress is not given to the chip due to the overall distortion of the printed circuit board and partial distortion such as at screw tightening portions.
- Self heating (temperature increase) occurs when the power is turned ON, so the tolerance should be sufficient for the set thermal design.
- Carefully lay out the coil for the circuit board design of the non-magnetic shield type.
A malfunction may occur due to magnetic interference.
- Use a wrist band to discharge static electricity in your body through the grounding wire.
- Do not expose the products to magnets or magnetic fields.
- Do not use for a purpose outside of the contents regulated in the delivery specifications.
- The products listed on this catalog are intended for use in general electronic equipment (AV equipment, telecommunications equipment, home appliances, amusement equipment, computer equipment, personal equipment, office equipment, measurement equipment, industrial robots) under a normal operation and use condition.
The products are not designed or warranted to meet the requirements of the applications listed below, whose performance and/or quality require a more stringent level of safety or reliability, or whose failure, malfunction or trouble could cause serious damage to society, person or property.
If you intend to use the products in the applications listed below or if you have special requirements exceeding the range or conditions set forth in the each catalog, please contact us.

- (1) Aerospace/Aviation equipment
- (2) Transportation equipment (electric trains, ships, etc.)
- (3) Medical equipment
- (4) Power-generation control equipment
- (5) Atomic energy-related equipment
- (6) Seabed equipment
- (7) Transportation control equipment

- (8) Public information-processing equipment
- (9) Military equipment
- (10) Electric heating apparatus, burning equipment
- (11) Disaster prevention/crime prevention equipment
- (12) Safety equipment
- (13) Other applications that are not considered general-purpose applications

When designing your equipment even for general-purpose applications, you are kindly requested to take into consideration securing protection circuit/device or providing backup circuits in your equipment.

Inductors for High Frequency Circuits

Multilayer Ceramic

Product compatible with RoHS directive
Halogen-free
Compatible with lead-free solders
AEC-Q200

Overview of MLG0603P Type

FEATURES

- High Q type inductor for high-frequency circuits.
- Inductance range: from 0.6 to 120nH.
- 0.1n step inductance lineup.
- Compared with existing products, the size was greatly reduced, making it optimal for fine-pitch circuits.
- Optimal configuration that greatly improves the Q to 800MHz or higher.
- Advanced monolithic structure is formed using a multilayering and sintering process with ceramic and conductive materials for High-frequency.

APPLICATION

Automotive equipment, smart phones, tablet terminals, high frequency modules (PAs, VCOs, FEMs , etc.), Bluetooth, W-LAN, UWB, tuners and other high frequency circuits for the mobile communication industry

PART NUMBER CONSTRUCTION

MLG	0603		P	0N6		B	T		D25
Series name	LxWxH Dimensions (mm)		Characteristics	Inductance (μH)		Inductance tolerance		Packaging style	Internal code
	0603	0.6x0.3x0.3	P	1N1	1.1	B	±0.1nH	T	Taping
				11N	11	C	±0.2nH		
						S	±0.3nH		
						H	±3%		
						J	±5%		

OPERATING TEMPERATURE RANGE, PACKAGE QUANTITY, PRODUCT WEIGHT

Type	Temperature range		Package quantity (pieces/reel)	Individual weight (mg)
	Operating temperature (°C)	Storage temperature* (°C)		
MLG0603P	-55 to +125	-55 to +125	15000	0.2

* The Storage temperature range is for after the circuit board is mounted.

- RoHS Directive Compliant Product: See the following for more details.<https://product.tdk.com/info/en/environment/rohs/index.html>
- Halogen-free: Indicates that Cl content is less than 900ppm, Br content is less than 900ppm, and that the total Cl and Br content is less than 1500ppm.

 Please be sure to request delivery specifications that provide further details on the features and specifications of the products for proper and safe use. Please note that the contents may change without any prior notice due to reasons such as upgrading.

MLG0603P Type

RECOMMENDED REFLOW PROFILE



Preheating			Soldering		Peak	
Temp.	Time		Temp.	Time	Temp.	Time
T1	T2	t1	T3	t2	T4	t3
150°C	180°C	60 to 120s	230°C	30 to 60s	250 to 260°C	10s max.

MLG0603P Type

SHAPE & DIMENSIONS

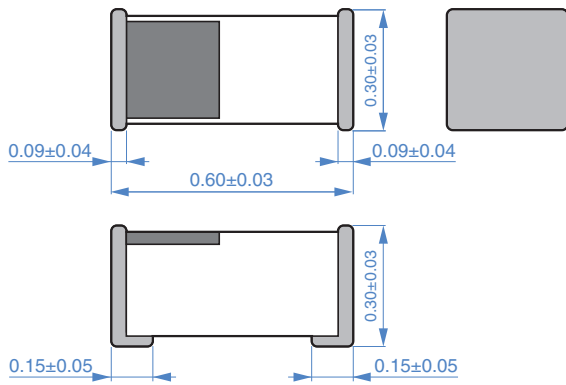

Dimensions in mm



RECOMMENDED LAND PATTERN

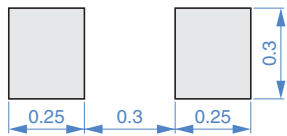

Dimensions in mm

MLG0603P Type

ELECTRICAL CHARACTERISTICS

CHARACTERISTICS SPECIFICATION TABLE

L (nH)	Q Tolerance	L, Q measuring frequency (MHz)	Self-resonant frequency		DC resistance		Rated current (mA)max.	Part No.*	
			(GHz)min.	(GHz)typ.	(Ω)max.	(Ω)typ.			
0.6	± 0.1 nH	—	500	10.0	20.0	0.06	0.01	1000	MLG0603P0N6BTD25
0.6	± 0.2 nH	—	500	10.0	20.0	0.06	0.01	1000	MLG0603P0N6CTD25
0.7	± 0.1 nH	—	500	10.0	20.0	0.06	0.01	1000	MLG0603P0N7BTD25
0.7	± 0.2 nH	—	500	10.0	20.0	0.06	0.01	1000	MLG0603P0N7CTD25
0.8	± 0.1 nH	—	500	10.0	20.0	0.06	0.02	1000	MLG0603P0N8BTD25
0.8	± 0.2 nH	—	500	10.0	20.0	0.06	0.02	1000	MLG0603P0N8CTD25
0.9	± 0.1 nH	—	500	10.0	20.0	0.06	0.02	1000	MLG0603P0N9BTD25
0.9	± 0.2 nH	—	500	10.0	20.0	0.06	0.02	1000	MLG0603P0N9CTD25
1.0	± 0.1 nH	14	500	10.0	20.0	0.07	0.02	1000	MLG0603P1N0BTD25
1.0	± 0.2 nH	14	500	10.0	20.0	0.07	0.02	1000	MLG0603P1N0CTD25
1.0	± 0.3 nH	14	500	10.0	20.0	0.07	0.02	1000	MLG0603P1N0STD25
1.1	± 0.1 nH	14	500	10.0	19.9	0.07	0.03	1000	MLG0603P1N1BTD25
1.1	± 0.2 nH	14	500	10.0	19.9	0.07	0.03	1000	MLG0603P1N1CTD25
1.1	± 0.3 nH	14	500	10.0	19.9	0.07	0.03	1000	MLG0603P1N1STD25
1.2	± 0.1 nH	14	500	10.0	16.0	0.08	0.04	800	MLG0603P1N2BTD25
1.2	± 0.2 nH	14	500	10.0	16.0	0.08	0.04	800	MLG0603P1N2CTD25
1.2	± 0.3 nH	14	500	10.0	16.0	0.08	0.04	800	MLG0603P1N2STD25
1.3	± 0.1 nH	14	500	10.0	13.9	0.08	0.03	800	MLG0603P1N3BTD25
1.3	± 0.2 nH	14	500	10.0	13.9	0.08	0.03	800	MLG0603P1N3CTD25
1.3	± 0.3 nH	14	500	10.0	13.9	0.08	0.03	800	MLG0603P1N3STD25
1.4	± 0.1 nH	14	500	10.0	11.7	0.09	0.04	800	MLG0603P1N4BTD25
1.4	± 0.2 nH	14	500	10.0	11.7	0.09	0.04	800	MLG0603P1N4CTD25
1.4	± 0.3 nH	14	500	10.0	11.7	0.09	0.04	800	MLG0603P1N4STD25
1.5	± 0.1 nH	14	500	10.0	14.9	0.10	0.03	800	MLG0603P1N5BTD25
1.5	± 0.2 nH	14	500	10.0	14.9	0.10	0.03	800	MLG0603P1N5CTD25
1.5	± 0.3 nH	14	500	10.0	14.9	0.10	0.03	800	MLG0603P1N5STD25
1.6	± 0.1 nH	14	500	10.0	13.4	0.10	0.03	700	MLG0603P1N6BTD25
1.6	± 0.2 nH	14	500	10.0	13.4	0.10	0.03	700	MLG0603P1N6CTD25
1.6	± 0.3 nH	14	500	10.0	13.4	0.10	0.03	700	MLG0603P1N6STD25
1.7	± 0.1 nH	14	500	10.0	12.8	0.10	0.02	700	MLG0603P1N7BTD25
1.7	± 0.2 nH	14	500	10.0	12.8	0.10	0.02	700	MLG0603P1N7CTD25
1.7	± 0.3 nH	14	500	10.0	12.8	0.10	0.02	700	MLG0603P1N7STD25
1.8	± 0.1 nH	14	500	9.0	10.7	0.10	0.03	700	MLG0603P1N8BTD25
1.8	± 0.2 nH	14	500	9.0	10.7	0.10	0.03	700	MLG0603P1N8CTD25
1.8	± 0.3 nH	14	500	9.0	10.7	0.10	0.03	700	MLG0603P1N8STD25
1.9	± 0.1 nH	14	500	9.0	10.9	0.10	0.04	600	MLG0603P1N9BTD25
1.9	± 0.2 nH	14	500	9.0	10.9	0.10	0.04	600	MLG0603P1N9CTD25
1.9	± 0.3 nH	14	500	9.0	10.9	0.10	0.04	600	MLG0603P1N9STD25
2.0	± 0.1 nH	14	500	8.5	10.1	0.10	0.03	600	MLG0603P2N0BTD25
2.0	± 0.2 nH	14	500	8.5	10.1	0.10	0.03	600	MLG0603P2N0CTD25
2.0	± 0.3 nH	14	500	8.5	10.1	0.10	0.03	600	MLG0603P2N0STD25
2.1	± 0.1 nH	14	500	8.0	9.8	0.10	0.05	600	MLG0603P2N1BTD25
2.1	± 0.2 nH	14	500	8.0	9.8	0.10	0.05	600	MLG0603P2N1CTD25
2.1	± 0.3 nH	14	500	8.0	9.8	0.10	0.05	600	MLG0603P2N1STD25
2.2	± 0.1 nH	14	500	7.5	9.0	0.10	0.07	600	MLG0603P2N2BTD25
2.2	± 0.2 nH	14	500	7.5	9.0	0.10	0.07	600	MLG0603P2N2CTD25

* Please contact us for information on inductance tolerance, G ($\pm 2\%$).

· Short bar residual inductance =0.43nH

Measurement equipment

Measurement item	Product No.	Manufacturer
L, Q	4291B+16197A	Keysight Technologies
Self-resonant frequency	8720C	Keysight Technologies
DC resistance	Type-7561	Yokogawa

* Equivalent measurement equipment may be used.

MLG0603P Type

ELECTRICAL CHARACTERISTICS

CHARACTERISTICS SPECIFICATION TABLE

L (nH)	Q Tolerance	Q	L, Q measuring frequency (MHz)	Self-resonant frequency		DC resistance		Rated current (mA)max.	Part No.*
				(GHz)min.	(GHz)typ.	(Ω)max.	(Ω)typ.		
2.2	± 0.3 nH	14	500	7.5	9.0	0.10	0.07	600	MLG0603P2N2STD25
2.3	± 0.1 nH	14	500	7.5	8.4	0.20	0.07	600	MLG0603P2N3BTD25
2.3	± 0.2 nH	14	500	7.5	8.4	0.20	0.07	600	MLG0603P2N3CTD25
2.3	± 0.3 nH	14	500	7.5	8.4	0.20	0.07	600	MLG0603P2N3STD25
2.4	± 0.1 nH	14	500	7.5	10.9	0.20	0.12	500	MLG0603P2N4BTD25
2.4	± 0.2 nH	14	500	7.5	10.9	0.20	0.12	500	MLG0603P2N4CTD25
2.4	± 0.3 nH	14	500	7.5	10.9	0.20	0.12	500	MLG0603P2N4STD25
2.5	± 0.1 nH	14	500	7.5	9.9	0.20	0.09	500	MLG0603P2N5BTD25
2.5	± 0.2 nH	14	500	7.5	9.9	0.20	0.09	500	MLG0603P2N5CTD25
2.5	± 0.3 nH	14	500	7.5	9.9	0.20	0.09	500	MLG0603P2N5STD25
2.6	± 0.1 nH	14	500	7.5	10.1	0.20	0.14	500	MLG0603P2N6BTD25
2.6	± 0.2 nH	14	500	7.5	10.1	0.20	0.14	500	MLG0603P2N6CTD25
2.6	± 0.3 nH	14	500	7.5	10.1	0.20	0.14	500	MLG0603P2N6STD25
2.7	± 0.1 nH	14	500	7.5	10.0	0.20	0.14	500	MLG0603P2N7BTD25
2.7	± 0.2 nH	14	500	7.5	10.0	0.20	0.14	500	MLG0603P2N7CTD25
2.7	± 0.3 nH	14	500	7.5	10.0	0.20	0.14	500	MLG0603P2N7STD25
2.8	± 0.1 nH	14	500	7.5	9.9	0.20	0.10	500	MLG0603P2N8BTD25
2.8	± 0.2 nH	14	500	7.5	9.9	0.20	0.10	500	MLG0603P2N8CTD25
2.8	± 0.3 nH	14	500	7.5	9.9	0.20	0.10	500	MLG0603P2N8STD25
2.9	± 0.1 nH	14	500	7.5	9.2	0.20	0.10	500	MLG0603P2N9BTD25
2.9	± 0.2 nH	14	500	7.5	9.2	0.20	0.10	500	MLG0603P2N9CTD25
2.9	± 0.3 nH	14	500	7.5	9.2	0.20	0.10	500	MLG0603P2N9STD25
3.0	± 0.1 nH	14	500	7.5	9.1	0.20	0.14	450	MLG0603P3N0BTD25
3.0	± 0.2 nH	14	500	7.5	9.1	0.20	0.14	450	MLG0603P3N0CTD25
3.0	± 0.3 nH	14	500	7.5	9.1	0.20	0.14	450	MLG0603P3N0STD25
3.1	± 0.1 nH	14	500	7.5	8.8	0.20	0.10	450	MLG0603P3N1BTD25
3.1	± 0.2 nH	14	500	7.5	8.8	0.20	0.10	450	MLG0603P3N1CTD25
3.1	± 0.3 nH	14	500	7.5	8.8	0.20	0.10	450	MLG0603P3N1STD25
3.2	± 0.1 nH	14	500	7.5	8.4	0.20	0.14	450	MLG0603P3N2BTD25
3.2	± 0.2 nH	14	500	7.5	8.4	0.20	0.14	450	MLG0603P3N2CTD25
3.2	± 0.3 nH	14	500	7.5	8.4	0.20	0.14	450	MLG0603P3N2STD25
3.3	± 0.1 nH	14	500	7.5	8.4	0.20	0.13	450	MLG0603P3N3BTD25
3.3	± 0.2 nH	14	500	7.5	8.4	0.20	0.13	450	MLG0603P3N3CTD25
3.3	± 0.3 nH	14	500	7.5	8.4	0.20	0.13	450	MLG0603P3N3STD25
3.4	± 0.1 nH	14	500	7.0	8.1	0.20	0.13	450	MLG0603P3N4BTD25
3.4	± 0.2 nH	14	500	7.0	8.1	0.20	0.13	450	MLG0603P3N4CTD25
3.4	± 0.3 nH	14	500	7.0	8.1	0.20	0.13	450	MLG0603P3N4STD25
3.5	± 0.1 nH	14	500	6.5	8.0	0.20	0.12	450	MLG0603P3N5BTD25
3.5	± 0.2 nH	14	500	6.5	8.0	0.20	0.12	450	MLG0603P3N5CTD25
3.5	± 0.3 nH	14	500	6.5	8.0	0.20	0.12	450	MLG0603P3N5STD25
3.6	± 0.1 nH	14	500	6.5	7.7	0.20	0.10	400	MLG0603P3N6BTD25
3.6	± 0.2 nH	14	500	6.5	7.7	0.20	0.10	400	MLG0603P3N6CTD25
3.6	± 0.3 nH	14	500	6.5	7.7	0.20	0.10	400	MLG0603P3N6STD25
3.7	± 0.1 nH	14	500	6.5	7.4	0.20	0.14	400	MLG0603P3N7BTD25
3.7	± 0.2 nH	14	500	6.5	7.4	0.20	0.14	400	MLG0603P3N7CTD25
3.7	± 0.3 nH	14	500	6.5	7.4	0.20	0.14	400	MLG0603P3N7STD25

* Please contact us for information on inductance tolerance, G ($\pm 2\%$).

· Short bar residual inductance =0.43nH

Measurement equipment

Measurement item	Product No.	Manufacturer
L, Q	4291B+16197A	Keysight Technologies
Self-resonant frequency	8720C	Keysight Technologies
DC resistance	Type-7561	Yokogawa

* Equivalent measurement equipment may be used.

 Please be sure to request delivery specifications that provide further details on the features and specifications of the products for proper and safe use.
Please note that the contents may change without any prior notice due to reasons such as upgrading.

MLG0603P Type

ELECTRICAL CHARACTERISTICS

CHARACTERISTICS SPECIFICATION TABLE

L (nH)	Q Tolerance	L, Q measuring frequency min. (MHz)	Self-resonant frequency		DC resistance		Rated current (mA)max.	Part No.*	
			(GHz)min.	(GHz)typ.	(Ω)max.	(Ω)typ.			
3.8	± 0.1 nH	14	500	5.8	7.0	0.30	0.24	400	MLG0603P3N8BTD25
3.8	± 0.2 nH	14	500	5.8	7.0	0.30	0.24	400	MLG0603P3N8CTD25
3.8	± 0.3 nH	14	500	5.8	7.0	0.30	0.24	400	MLG0603P3N8STD25
3.9	± 0.1 nH	14	500	5.8	7.1	0.30	0.22	400	MLG0603P3N9BTD25
3.9	± 0.2 nH	14	500	5.8	7.1	0.30	0.22	400	MLG0603P3N9CTD25
3.9	± 0.3 nH	14	500	5.8	7.1	0.30	0.22	400	MLG0603P3N9STD25
4.0	± 0.1 nH	14	500	5.8	6.7	0.40	0.21	350	MLG0603P4N0BTD25
4.0	± 0.2 nH	14	500	5.8	6.7	0.40	0.21	350	MLG0603P4N0CTD25
4.0	± 0.3 nH	14	500	5.8	6.7	0.40	0.21	350	MLG0603P4N0STD25
4.1	± 0.1 nH	14	500	5.8	6.7	0.40	0.29	350	MLG0603P4N1BTD25
4.1	± 0.2 nH	14	500	5.8	6.7	0.40	0.29	350	MLG0603P4N1CTD25
4.1	± 0.3 nH	14	500	5.8	6.7	0.40	0.29	350	MLG0603P4N1STD25
4.2	± 0.1 nH	14	500	5.8	6.6	0.40	0.24	350	MLG0603P4N2BTD25
4.2	± 0.2 nH	14	500	5.8	6.6	0.40	0.24	350	MLG0603P4N2CTD25
4.2	± 0.3 nH	14	500	5.8	6.6	0.40	0.24	350	MLG0603P4N2STD25
4.3	± 0.3 nH	14	500	5.8	6.7	0.40	0.24	350	MLG0603P4N3STD25
4.3	$\pm 5\%$	14	500	5.8	6.7	0.40	0.24	350	MLG0603P4N3JTD25
4.7	± 0.3 nH	14	500	5.5	6.9	0.40	0.16	350	MLG0603P4N7STD25
4.7	$\pm 5\%$	14	500	5.5	6.9	0.40	0.16	350	MLG0603P4N7JTD25
5.1	± 0.3 nH	14	500	5.5	6.6	0.40	0.30	350	MLG0603P5N1STD25
5.1	$\pm 5\%$	14	500	5.5	6.6	0.40	0.30	350	MLG0603P5N1JTD25
5.6	± 0.3 nH	14	500	4.0	5.3	0.40	0.32	350	MLG0603P5N6STD25
5.6	$\pm 5\%$	14	500	4.0	5.3	0.40	0.32	350	MLG0603P5N6JTD25
6.2	± 0.3 nH	14	500	4.0	6.3	0.70	0.59	300	MLG0603P6N2STD25
6.2	$\pm 5\%$	14	500	4.0	6.3	0.70	0.59	300	MLG0603P6N2JTD25
6.8	$\pm 3\%$	14	500	4.0	6.1	0.75	0.62	300	MLG0603P6N8HTD25
6.8	$\pm 5\%$	14	500	4.0	6.1	0.75	0.62	300	MLG0603P6N8JTD25
7.5	$\pm 3\%$	14	500	4.0	5.4	0.80	0.70	300	MLG0603P7N5HTD25
7.5	$\pm 5\%$	14	500	4.0	5.4	0.80	0.70	300	MLG0603P7N5JTD25
8.2	$\pm 3\%$	14	500	4.0	5.2	0.85	0.71	250	MLG0603P8N2HTD25
8.2	$\pm 5\%$	14	500	4.0	5.2	0.85	0.71	250	MLG0603P8N2JTD25
9.1	$\pm 3\%$	14	500	4.0	5.0	0.90	0.76	250	MLG0603P9N1HTD25
9.1	$\pm 5\%$	14	500	4.0	5.0	0.90	0.76	250	MLG0603P9N1JTD25
10.0	$\pm 3\%$	14	500	4.0	4.7	0.95	0.85	250	MLG0603P10NHTD25
10.0	$\pm 5\%$	14	500	4.0	4.7	0.95	0.85	250	MLG0603P10NJTD25
11.0	$\pm 3\%$	14	500	3.5	4.5	1.00	0.64	250	MLG0603P11NHTD25
11.0	$\pm 5\%$	14	500	3.5	4.5	1.00	0.64	250	MLG0603P11NJTD25
12.0	$\pm 3\%$	14	500	3.5	4.3	1.10	0.82	250	MLG0603P12NHTD25
12.0	$\pm 5\%$	14	500	3.5	4.3	1.10	0.82	250	MLG0603P12NJTD25
13.0	$\pm 3\%$	14	500	3.2	4.2	1.10	0.87	250	MLG0603P13NHTD25
13.0	$\pm 5\%$	14	500	3.2	4.2	1.10	0.87	250	MLG0603P13NJTD25
15.0	$\pm 3\%$	14	500	3.2	3.7	1.20	0.94	250	MLG0603P15NHTD25
15.0	$\pm 5\%$	14	500	3.2	3.7	1.20	0.94	250	MLG0603P15NJTD25
16.0	$\pm 3\%$	14	500	3.0	3.6	1.20	1.00	200	MLG0603P16NHTD25
16.0	$\pm 5\%$	14	500	3.0	3.6	1.20	1.00	200	MLG0603P16NJTD25
18.0	$\pm 3\%$	14	500	3.0	3.5	1.40	1.04	200	MLG0603P18NHTD25

* Please contact us for information on inductance tolerance, G ($\pm 2\%$).

· Short bar residual inductance = 0.43nH

○ Measurement equipment

Measurement item	Product No.	Manufacturer
L, Q	4291B+16197A	Keysight Technologies
Self-resonant frequency	8720C	Keysight Technologies
DC resistance	Type-7561	Yokogawa

* Equivalent measurement equipment may be used.

⚠ Please be sure to request delivery specifications that provide further details on the features and specifications of the products for proper and safe use.
Please note that the contents may change without any prior notice due to reasons such as upgrading.

MLG0603P Type

ELECTRICAL CHARACTERISTICS

CHARACTERISTICS SPECIFICATION TABLE

L (nH)	Q Tolerance	L, Q measuring frequency		Self-resonant frequency		DC resistance		Rated current (mA)max.	Part No.*
		min.	(MHz)	(GHz)min.	(GHz)typ.	(Ω)max.	(Ω)typ.		
18.0	$\pm 5\%$	14	500	3.0	3.5	1.40	1.04	200	MLG0603P18NJTD25
20.0	$\pm 3\%$	14	500	2.2	3.3	1.90	1.33	150	MLG0603P20NHTD25
20.0	$\pm 5\%$	14	500	2.2	3.3	1.90	1.33	150	MLG0603P20NJTD25
22.0	$\pm 3\%$	14	500	2.2	2.9	1.90	1.31	150	MLG0603P22NHTD25
22.0	$\pm 5\%$	14	500	2.2	2.9	1.90	1.31	150	MLG0603P22NJTD25
24.0	$\pm 3\%$	14	500	2.2	2.9	2.10	1.17	140	MLG0603P24NHTD25
24.0	$\pm 5\%$	14	500	2.2	2.9	2.10	1.17	140	MLG0603P24NJTD25
27.0	$\pm 3\%$	14	500	2.2	2.7	2.10	1.45	140	MLG0603P27NHTD25
27.0	$\pm 5\%$	14	500	2.2	2.7	2.10	1.45	140	MLG0603P27NJTD25
30.0	$\pm 3\%$	10	500	1.8	2.3	2.20	1.37	130	MLG0603P30NHTD25
30.0	$\pm 5\%$	10	500	1.8	2.3	2.20	1.37	130	MLG0603P30NJTD25
33.0	$\pm 3\%$	10	300	1.8	2.4	2.20	1.55	130	MLG0603P33NHTD25
33.0	$\pm 5\%$	10	300	1.8	2.4	2.20	1.55	130	MLG0603P33NJTD25
36.0	$\pm 3\%$	10	300	1.8	2.2	2.40	1.49	120	MLG0603P36NHTD25
36.0	$\pm 5\%$	10	300	1.8	2.2	2.40	1.49	120	MLG0603P36NJTD25
39.0	$\pm 3\%$	10	300	1.8	2.2	2.40	1.72	120	MLG0603P39NHTD25
39.0	$\pm 5\%$	10	300	1.8	2.2	2.40	1.72	120	MLG0603P39NJTD25
43.0	$\pm 3\%$	10	300	1.6	2.0	2.90	1.61	110	MLG0603P43NHTD25
43.0	$\pm 5\%$	10	300	1.6	2.0	2.90	1.61	110	MLG0603P43NJTD25
47.0	$\pm 3\%$	10	300	1.6	2.0	2.90	2.18	110	MLG0603P47NHTD25
47.0	$\pm 5\%$	10	300	1.6	2.0	2.90	2.18	110	MLG0603P47NJTD25
51.0	$\pm 3\%$	10	300	1.4	1.9	3.50	1.87	100	MLG0603P51NHTD25
51.0	$\pm 5\%$	10	300	1.4	1.9	3.50	1.87	100	MLG0603P51NJTD25
56.0	$\pm 3\%$	10	300	1.4	1.8	3.50	2.35	100	MLG0603P56NHTD25
56.0	$\pm 5\%$	10	300	1.4	1.8	3.50	2.35	100	MLG0603P56NJTD25
62.0	$\pm 3\%$	10	300	1.2	1.6	3.50	2.12	100	MLG0603P62NHTD25
62.0	$\pm 5\%$	10	300	1.2	1.6	3.50	2.12	100	MLG0603P62NJTD25
68.0	$\pm 3\%$	9	300	1.2	1.6	3.50	2.69	100	MLG0603P68NHTD25
68.0	$\pm 5\%$	9	300	1.2	1.6	3.50	2.69	100	MLG0603P68NJTD25
75.0	$\pm 3\%$	9	300	1.0	1.5	4.00	2.59	80	MLG0603P75NHTD25
75.0	$\pm 5\%$	9	300	1.0	1.5	4.00	2.59	80	MLG0603P75NJTD25
82.0	$\pm 3\%$	9	300	1.0	1.5	4.00	2.71	80	MLG0603P82NHTD25
82.0	$\pm 5\%$	9	300	1.0	1.5	4.00	2.71	80	MLG0603P82NJTD25
91.0	$\pm 3\%$	9	300	0.9	1.3	4.50	2.92	80	MLG0603P91NHTD25
91.0	$\pm 5\%$	9	300	0.9	1.3	4.50	2.92	80	MLG0603P91NJTD25
100.0	$\pm 3\%$	9	300	0.9	1.3	4.50	3.20	80	MLG0603PR10HTD25
100.0	$\pm 5\%$	9	300	0.9	1.3	4.50	3.20	80	MLG0603PR10JTD25
110.0	$\pm 3\%$	9	300	0.8	1.1	5.00	3.50	80	MLG0603PR11HTD25
110.0	$\pm 5\%$	9	300	0.8	1.1	5.00	3.50	80	MLG0603PR11JTD25
120.0	$\pm 3\%$	9	300	0.8	1.0	5.00	3.79	80	MLG0603PR12HTD25
120.0	$\pm 5\%$	9	300	0.8	1.0	5.00	3.79	80	MLG0603PR12JTD25

* Please contact us for information on inductance tolerance, G ($\pm 2\%$).

· Short bar residual inductance =0.43nH

Measurement equipment

Measurement item	Product No.	Manufacturer
L, Q	4291B+16197A	Keysight Technologies
Self-resonant frequency	8720C	Keysight Technologies
DC resistance	Type-7561	Yokogawa

* Equivalent measurement equipment may be used.

MLG0603P Type

ELECTRICAL CHARACTERISTICS

L, Q FREQUENCY CHARACTERISTICS TABLE

L(nH)typ.		Q typ.					Part No.*			
500MHz	800MHz	1.8GHz	2.0GHz	2.4GHz	500MHz	800MHz		1.8GHz	2.0GHz	2.4GHz
0.6	0.6	0.6	0.6	0.6	16min.	22min.	35min.	37min.	41min.	MLG0603P0N6BTD25
0.6	0.6	0.6	0.6	0.6	16min.	22min.	35min.	37min.	41min.	MLG0603P0N6CTD25
0.7	0.7	0.7	0.7	0.7	16min.	22min.	35min.	37min.	41min.	MLG0603P0N7BTD25
0.7	0.7	0.7	0.7	0.7	16min.	22min.	35min.	37min.	41min.	MLG0603P0N7CTD25
0.8	0.8	0.8	0.8	0.4	16	22	35	37	41	MLG0603P0N8BTD25
0.8	0.8	0.8	0.8	0.4	16	22	35	37	41	MLG0603P0N8CTD25
0.9	0.9	0.9	0.9	0.9	17	22	35	37	41	MLG0603P0N9BTD25
0.9	0.9	0.9	0.9	0.9	17	22	35	37	41	MLG0603P0N9CTD25
1.0	1.0	1.0	1.0	1.0	16	21	33	36	40	MLG0603P1N0BTD25
1.0	1.0	1.0	1.0	1.0	16	21	33	36	40	MLG0603P1N0CTD25
1.0	1.0	1.0	1.0	1.0	16	21	33	36	40	MLG0603P1N0STD25
1.1	1.1	1.1	1.1	1.1	17	23	36	38	43	MLG0603P1N1BTD25
1.1	1.1	1.1	1.1	1.1	17	23	36	38	43	MLG0603P1N1CTD25
1.1	1.1	1.1	1.1	1.1	17	23	36	38	43	MLG0603P1N1STD25
1.2	1.2	1.2	1.2	1.2	18	24	38	40	45	MLG0603P1N2BTD25
1.2	1.2	1.2	1.2	1.2	18	24	38	40	45	MLG0603P1N2CTD25
1.2	1.2	1.2	1.2	1.2	18	24	38	40	45	MLG0603P1N2STD25
1.3	1.3	1.3	1.3	1.3	17	22	34	36	40	MLG0603P1N3BTD25
1.3	1.3	1.3	1.3	1.3	17	22	34	36	40	MLG0603P1N3CTD25
1.3	1.3	1.3	1.3	1.3	17	22	34	36	40	MLG0603P1N3STD25
1.4	1.4	1.4	1.4	1.4	18	23	36	39	43	MLG0603P1N4BTD25
1.4	1.4	1.4	1.4	1.4	18	23	36	39	43	MLG0603P1N4CTD25
1.4	1.4	1.4	1.4	1.4	18	23	36	39	43	MLG0603P1N4STD25
1.5	1.5	1.5	1.5	1.5	17	22	33	35	39	MLG0603P1N5BTD25
1.5	1.5	1.5	1.5	1.5	17	22	33	35	39	MLG0603P1N5CTD25
1.5	1.5	1.5	1.5	1.5	17	22	33	35	39	MLG0603P1N5STD25
1.6	1.6	1.6	1.6	1.6	17	22	33	35	38	MLG0603P1N6BTD25
1.6	1.6	1.6	1.6	1.6	17	22	33	35	38	MLG0603P1N6CTD25
1.6	1.6	1.6	1.6	1.6	17	22	33	35	38	MLG0603P1N6STD25
1.7	1.7	1.7	1.7	1.7	17	22	33	35	39	MLG0603P1N7BTD25
1.7	1.7	1.7	1.7	1.7	17	22	33	35	39	MLG0603P1N7CTD25
1.7	1.7	1.7	1.7	1.7	17	22	33	35	39	MLG0603P1N7STD25
1.8	1.8	1.8	1.8	1.8	17	22	34	35	39	MLG0603P1N8BTD25
1.8	1.8	1.8	1.8	1.8	17	22	34	35	39	MLG0603P1N8CTD25
1.8	1.8	1.8	1.8	1.8	17	22	34	35	39	MLG0603P1N8STD25
1.9	1.9	1.9	1.9	1.9	18	24	36	38	42	MLG0603P1N9BTD25
1.9	1.9	1.9	1.9	1.9	18	24	36	38	42	MLG0603P1N9CTD25
1.9	1.9	1.9	1.9	1.9	18	24	36	38	42	MLG0603P1N9STD25
2.0	2.0	2.0	2.0	2.0	19	23	35	37	41	MLG0603P2N0BTD25
2.0	2.0	2.0	2.0	2.0	19	23	35	37	41	MLG0603P2N0CTD25
2.0	2.0	2.0	2.0	2.0	19	23	35	37	41	MLG0603P2N0STD25
2.1	2.1	2.1	2.1	2.1	18	23	34	36	39	MLG0603P2N1BTD25
2.1	2.1	2.1	2.1	2.1	18	23	34	36	39	MLG0603P2N1CTD25
2.1	2.1	2.1	2.1	2.1	18	23	34	36	39	MLG0603P2N1STD25
2.2	2.2	2.2	2.2	2.3	18	23	35	36	40	MLG0603P2N2BTD25
2.2	2.2	2.2	2.2	2.3	18	23	35	36	40	MLG0603P2N2CTD25
2.2	2.2	2.2	2.2	2.3	18	23	35	36	40	MLG0603P2N2STD25
2.3	2.3	2.3	2.4	2.4	18	22	33	35	38	MLG0603P2N3BTD25
2.3	2.3	2.3	2.4	2.4	18	22	33	35	38	MLG0603P2N3CTD25
2.3	2.3	2.3	2.4	2.4	18	22	33	35	38	MLG0603P2N3STD25
2.4	2.4	2.4	2.4	2.4	16	21	31	33	36	MLG0603P2N4BTD25
2.4	2.4	2.4	2.4	2.4	16	21	31	33	36	MLG0603P2N4CTD25
2.4	2.4	2.4	2.4	2.4	16	21	31	33	36	MLG0603P2N4STD25

* Please contact us for information on inductance tolerance, G ($\pm 2\%$).

○ Measurement equipment

Product No.	Manufacturer
4291B+16197A	Keysight Technologies

* Equivalent measurement equipment may be used.

⚠ Please be sure to request delivery specifications that provide further details on the features and specifications of the products for proper and safe use.
Please note that the contents may change without any prior notice due to reasons such as upgrading.

MLG0603P Type

ELECTRICAL CHARACTERISTICS

L, Q FREQUENCY CHARACTERISTICS TABLE

L(nH)typ.		Q typ.					Part No.*			
500MHz	800MHz	1.8GHz	2.0GHz	2.4GHz	500MHz	800MHz		1.8GHz	2.0GHz	2.4GHz
2.5	2.5	2.5	2.5	2.5	17	22	33	34	38	MLG0603P2N5BTD25
2.5	2.5	2.5	2.5	2.5	17	22	33	34	38	MLG0603P2N5CTD25
2.5	2.5	2.5	2.5	2.5	17	22	33	34	38	MLG0603P2N5STD25
2.6	2.6	2.6	2.6	2.6	17	22	33	35	38	MLG0603P2N6BTD25
2.6	2.6	2.6	2.6	2.6	17	22	33	35	38	MLG0603P2N6CTD25
2.6	2.6	2.6	2.6	2.6	17	22	33	35	38	MLG0603P2N6STD25
2.7	2.7	2.7	2.7	2.7	17	21	33	35	38	MLG0603P2N7BTD25
2.7	2.7	2.7	2.7	2.7	17	21	33	35	38	MLG0603P2N7CTD25
2.7	2.7	2.7	2.7	2.7	17	21	33	35	38	MLG0603P2N7STD25
2.8	2.8	2.8	2.8	2.9	17	22	34	36	40	MLG0603P2N8BTD25
2.8	2.8	2.8	2.8	2.9	17	22	34	36	40	MLG0603P2N8CTD25
2.8	2.8	2.8	2.8	2.9	17	22	34	36	40	MLG0603P2N8STD25
2.9	2.9	2.9	2.9	3.0	17	22	34	35	39	MLG0603P2N9BTD25
2.9	2.9	2.9	2.9	3.0	17	22	34	35	39	MLG0603P2N9CTD25
2.9	2.9	2.9	2.9	3.0	17	22	34	35	39	MLG0603P2N9STD25
3.0	3.0	3.0	3.1	3.1	17	21	32	34	37	MLG0603P3N0BTD25
3.0	3.0	3.0	3.1	3.1	17	21	32	34	37	MLG0603P3N0CTD25
3.0	3.0	3.0	3.1	3.1	17	21	32	34	37	MLG0603P3N0STD25
3.1	3.1	3.1	3.2	3.2	17	22	33	34	37	MLG0603P3N1BTD25
3.1	3.1	3.1	3.2	3.2	17	22	33	34	37	MLG0603P3N1CTD25
3.1	3.1	3.1	3.2	3.2	17	22	33	34	37	MLG0603P3N1STD25
3.2	3.2	3.2	3.3	3.3	17	22	34	35	38	MLG0603P3N2BTD25
3.2	3.2	3.2	3.3	3.3	17	22	34	35	38	MLG0603P3N2CTD25
3.2	3.2	3.2	3.3	3.3	17	22	34	35	38	MLG0603P3N2STD25
3.3	3.3	3.4	3.4	3.4	18	22	33	35	38	MLG0603P3N3BTD25
3.3	3.3	3.4	3.4	3.4	18	22	33	35	38	MLG0603P3N3CTD25
3.3	3.3	3.4	3.4	3.4	18	22	33	35	38	MLG0603P3N3STD25
3.4	3.4	3.5	3.5	3.6	18	23	34	35	38	MLG0603P3N4BTD25
3.4	3.4	3.5	3.5	3.6	18	23	34	35	38	MLG0603P3N4CTD25
3.4	3.4	3.5	3.5	3.6	18	23	34	35	38	MLG0603P3N4STD25
3.5	3.5	3.6	3.6	3.7	18	23	34	35	38	MLG0603P3N5BTD25
3.5	3.5	3.6	3.6	3.7	18	23	34	35	38	MLG0603P3N5CTD25
3.5	3.5	3.6	3.6	3.7	18	23	34	35	38	MLG0603P3N5STD25
3.6	3.6	3.7	3.7	3.8	18	22	33	34	37	MLG0603P3N6BTD25
3.6	3.6	3.7	3.7	3.8	18	22	33	34	37	MLG0603P3N6CTD25
3.6	3.6	3.7	3.7	3.8	18	22	33	34	37	MLG0603P3N6STD25
3.7	3.7	3.8	3.9	4.0	18	23	34	35	37	MLG0603P3N7BTD25
3.7	3.7	3.8	3.9	4.0	18	23	34	35	37	MLG0603P3N7CTD25
3.7	3.7	3.8	3.9	4.0	18	23	34	35	37	MLG0603P3N7STD25
3.8	3.8	3.9	4.0	4.1	17	22	32	33	36	MLG0603P3N8BTD25
3.8	3.8	3.9	4.0	4.1	17	22	32	33	36	MLG0603P3N8CTD25
3.8	3.8	3.9	4.0	4.1	17	22	32	33	36	MLG0603P3N8STD25
3.9	3.9	4.0	4.1	4.2	17	22	32	34	36	MLG0603P3N9BTD25
3.9	3.9	4.0	4.1	4.2	17	22	32	34	36	MLG0603P3N9CTD25
3.9	3.9	4.0	4.1	4.2	17	22	32	34	36	MLG0603P3N9STD25
4.0	4.0	4.1	4.2	4.4	18	22	32	33	36	MLG0603P4N0BTD25
4.0	4.0	4.1	4.2	4.4	18	22	32	33	36	MLG0603P4N0CTD25
4.0	4.0	4.1	4.2	4.4	18	22	32	33	36	MLG0603P4N0STD25
4.1	4.1	4.3	4.3	4.5	18	22	33	34	36	MLG0603P4N1BTD25
4.1	4.1	4.3	4.3	4.5	18	22	33	34	36	MLG0603P4N1CTD25
4.1	4.1	4.3	4.3	4.5	18	22	33	34	36	MLG0603P4N1STD25
4.2	4.2	4.4	4.5	4.6	18	22	32	33	35	MLG0603P4N2BTD25

* Please contact us for information on inductance tolerance, G ($\pm 2\%$).

○ Measurement equipment

Product No.	Manufacturer
4291B+16197A	Keysight Technologies

* Equivalent measurement equipment may be used.

 Please be sure to request delivery specifications that provide further details on the features and specifications of the products for proper and safe use.
Please note that the contents may change without any prior notice due to reasons such as upgrading.

MLG0603P Type

ELECTRICAL CHARACTERISTICS

L, Q FREQUENCY CHARACTERISTICS TABLE

L(nH)typ.		Q typ.					Part No.*			
500MHz	800MHz	1.8GHz	2.0GHz	2.4GHz	500MHz	800MHz		1.8GHz	2.0GHz	2.4GHz
4.2	4.2	4.4	4.5	4.6	18	22	32	33	35	MLG0603P4N2CTD25
4.2	4.2	4.4	4.5	4.6	18	22	32	33	35	MLG0603P4N2STD25
4.3	4.3	4.5	4.5	4.7	17	21	32	33	35	MLG0603P4N3STD25
4.3	4.3	4.5	4.5	4.7	17	21	32	33	35	MLG0603P4N3JTD25
4.7	4.7	4.9	5.0	5.1	16	21	31	32	34	MLG0603P4N7STD25
4.7	4.7	4.9	5.0	5.1	16	21	31	32	34	MLG0603P4N7JTD25
5.1	5.1	5.3	5.4	5.7	16	21	31	32	34	MLG0603P5N1STD25
5.1	5.1	5.3	5.4	5.7	16	21	31	32	34	MLG0603P5N1JTD25
5.6	5.6	6.1	6.2	6.6	18	22	31	32	32	MLG0603P5N6STD25
5.6	5.6	6.1	6.2	6.6	18	22	31	32	32	MLG0603P5N6JTD25
6.2	6.2	6.5	6.7	7.0	16	21	30	31	33	MLG0603P6N2STD25
6.2	6.2	6.5	6.7	7.0	16	21	30	31	33	MLG0603P6N2JTD25
6.8	6.8	7.3	7.5	8.0	16	21	29	30	31	MLG0603P6N8HTD25
6.8	6.8	7.3	7.5	8.0	16	21	29	30	31	MLG0603P6N8JTD25
7.5	7.5	8.1	8.3	8.8	16	21	30	30	32	MLG0603P7N5HTD25
7.5	7.5	8.1	8.3	8.8	16	21	30	30	32	MLG0603P7N5JTD25
8.2	8.2	9.0	9.3	10.0	17	21	30	30	31	MLG0603P8N2HTD25
8.2	8.2	9.0	9.3	10.0	17	21	30	30	31	MLG0603P8N2JTD25
9.1	9.1	10.0	10.3	11.1	17	21	30	31	32	MLG0603P9N1HTD25
9.1	9.1	10.0	10.3	11.1	17	21	30	31	32	MLG0603P9N1JTD25
10	10	11	12	13	16	21	28	28	28	MLG0603P10NHTD25
10	10	11	12	13	16	21	28	28	28	MLG0603P10NJTD25
11	11	13	13	15	18	23	30	30	30	MLG0603P11NHTD25
11	11	13	13	15	18	23	30	30	30	MLG0603P11NJTD25
12	12	14	15	17	18	22	28	28	27	MLG0603P12NHTD25
12	12	14	15	17	18	22	28	28	27	MLG0603P12NJTD25
13	13	15	16	19	18	22	28	28	26	MLG0603P13NHTD25
13	13	15	16	19	18	22	28	28	26	MLG0603P13NJTD25
15	15	18	20	24	18	22	27	26	24	MLG0603P15NHTD25
15	15	18	20	24	18	22	27	26	24	MLG0603P15NJTD25
16	16	20	22	27	18	22	26	25	22	MLG0603P16NHTD25
16	16	20	22	27	18	22	26	25	22	MLG0603P16NJTD25
18	18	23	26	33	18	22	25	24	20	MLG0603P18NHTD25
18	18	23	26	33	18	22	25	24	20	MLG0603P18NJTD25
20	21	27	31	42	18	22	23	22	17	MLG0603P20NHTD25
20	21	27	31	42	18	22	23	22	17	MLG0603P20NJTD25
22	23	34	40	68	18	21	21	18	11	MLG0603P22NHTD25
22	23	34	40	68	18	21	21	18	11	MLG0603P22NJTD25
24	25	36	43	72	19	22	21	18	11	MLG0603P24NHTD25
24	25	36	43	72	19	22	21	18	11	MLG0603P24NJTD25
27	28	45	57		18	21	18	15		MLG0603P27NHTD25
27	28	45	57		18	21	18	15		MLG0603P27NJTD25
30	32	59			18	21	15			MLG0603P30NHTD25
30	32	59			18	21	15			MLG0603P30NJTD25
33	36	68			15	17	11			MLG0603P33NHTD25
33	36	68			15	17	11			MLG0603P33NJTD25
37	39				16	17				MLG0603P36NHTD25
37	39				16	17				MLG0603P36NJTD25
40	43				15	17				MLG0603P39NHTD25
40	43				15	17				MLG0603P39NJTD25
44	48				15	16				MLG0603P43NHTD25
44	48				15	16				MLG0603P43NJTD25

* Please contact us for information on inductance tolerance, G ($\pm 2\%$).

○ Measurement equipment

Product No.	Manufacturer
4291B+16197A	Keysight Technologies

* Equivalent measurement equipment may be used.

 Please be sure to request delivery specifications that provide further details on the features and specifications of the products for proper and safe use.
Please note that the contents may change without any prior notice due to reasons such as upgrading.

MLG0603P Type

ELECTRICAL CHARACTERISTICS

L, Q FREQUENCY CHARACTERISTICS TABLE

L(nH)typ.		1.8GHz	2.0GHz	2.4GHz	Q typ.		1.8GHz	2.0GHz	2.4GHz	Part No.*
500MHz	800MHz				500MHz	800MHz				
48	53				15	16				MLG0603P47NHTD25
48	53				15	16				MLG0603P47NJTD25
53	59				15	16				MLG0603P51NHTD25
53	59				15	16				MLG0603P51NJTD25
58	66				15	15				MLG0603P56NHTD25
58	66				15	15				MLG0603P56NJTD25
65	76				15	15				MLG0603P62NHTD25
65	76				15	15				MLG0603P62NJTD25
71	82				15	15				MLG0603P68NHTD25
71	82				15	15				MLG0603P68NJTD25
79	97				14	13				MLG0603P75NHTD25
79	97				14	13				MLG0603P75NJTD25
87	109				14	13				MLG0603P82NHTD25
87	109				14	13				MLG0603P82NJTD25
99	132				13	12				MLG0603P91NHTD25
99	132				13	12				MLG0603P91NJTD25
110	152				14	12				MLG0603PR10HTD25
110	152				14	12				MLG0603PR10JTD25
126	211				13	9				MLG0603PR11HTD25
126	211				13	9				MLG0603PR11JTD25
151					12					MLG0603PR12HTD25
151					12					MLG0603PR12JTD25

* Please contact us for information on inductance tolerance, G ($\pm 2\%$).

○ Measurement equipment

Product No.	Manufacturer
4291B+16197A	Keysight Technologies

* Equivalent measurement equipment may be used.

MLG0603P Type

ELECTRICAL CHARACTERISTICS

L FREQUENCY CHARACTERISTICS GRAPH (EXAMPLE)

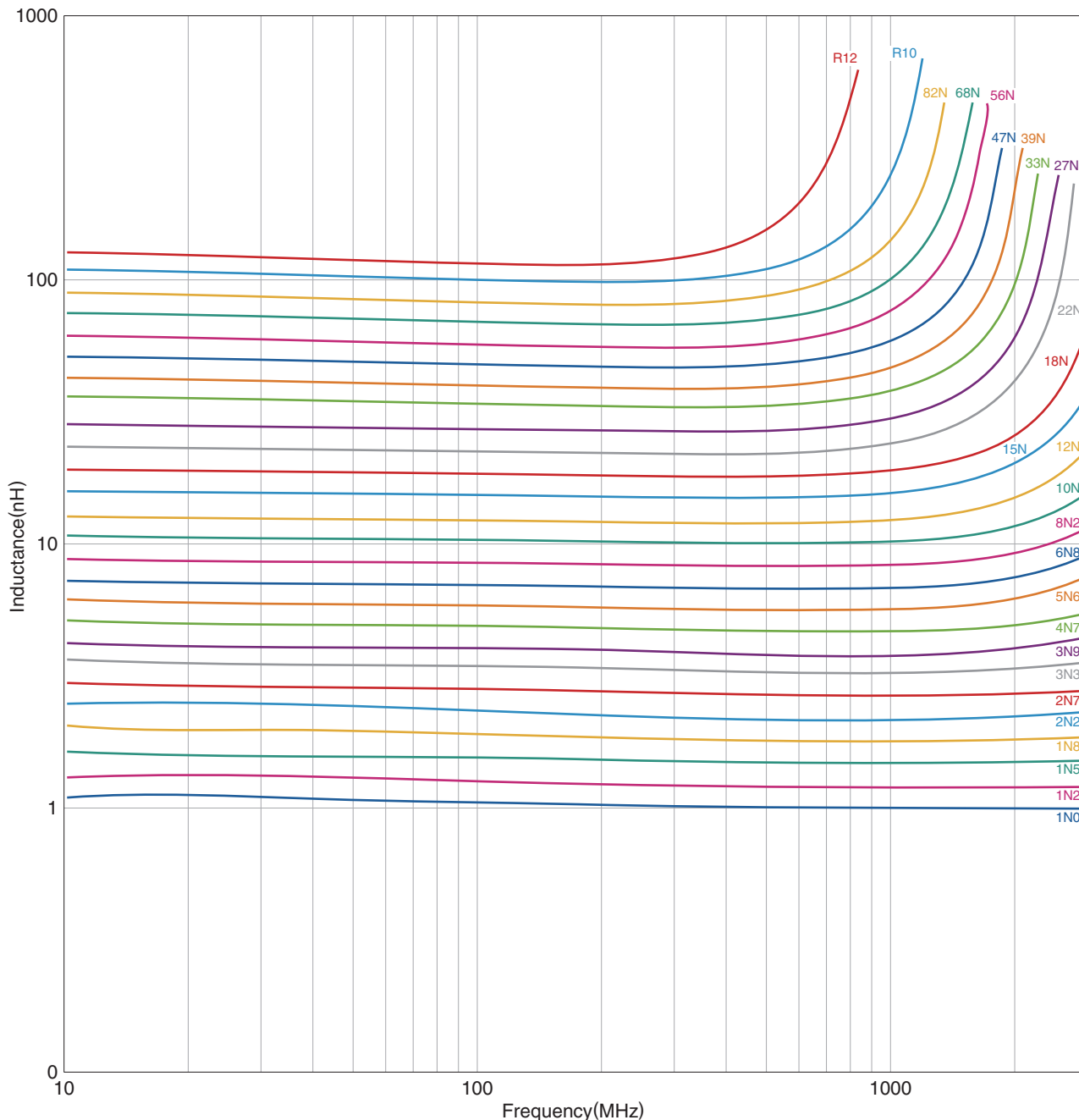

○ Measurement equipment

Product No.	Manufacturer
E4991A+16197A	Keysight Technologies

* Equivalent measurement equipment may be used.

⚠ Please be sure to request delivery specifications that provide further details on the features and specifications of the products for proper and safe use.
Please note that the contents may change without any prior notice due to reasons such as upgrading.

MLG0603P Type

ELECTRICAL CHARACTERISTICS

Q FREQUENCY CHARACTERISTICS GRAPH (EXAMPLE)

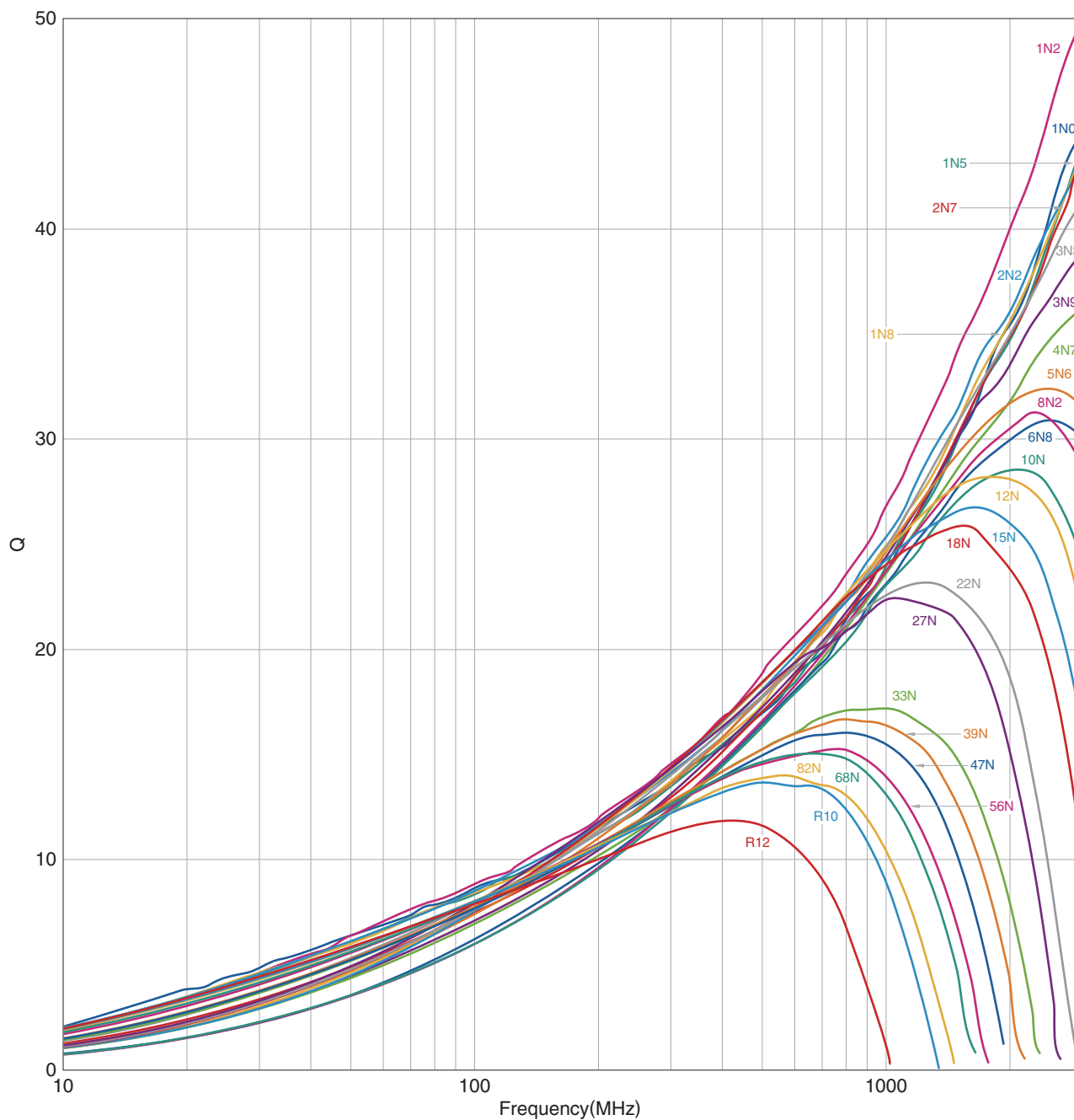

○ Measurement equipment

Product No.	Manufacturer
E4991A+16197A	Keysight Technologies

* Equivalent measurement equipment may be used.

⚠ Please be sure to request delivery specifications that provide further details on the features and specifications of the products for proper and safe use.
Please note that the contents may change without any prior notice due to reasons such as upgrading.

MLG0603P Type

PACKAGING STYLE

REEL DIMENSIONS

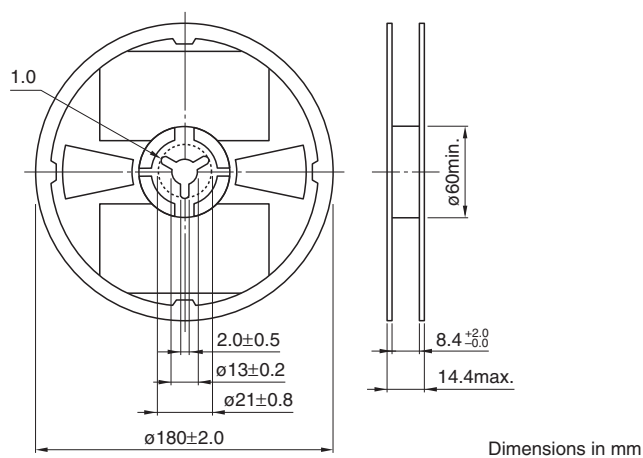

TAPE DIMENSIONS

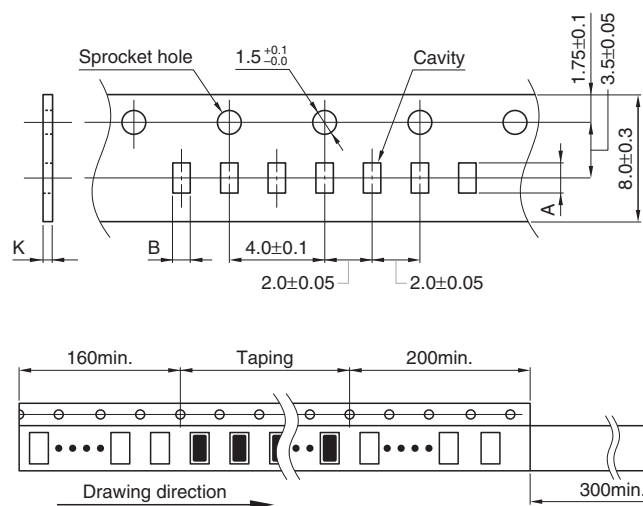

Type	A	B	K
MLG0603P	0.68 ± 0.05	0.38 ± 0.05	0.5 max.