



PI-7907-040416

Figure 3. Block Diagram.

Pin Functional Description

BYPASS (BP) Pin:

5.25 V supply rail.

MULTIFUNCTION (M) Pin:

Mode 1: FET OFF

- Detection of inductor de-magnetization (ZCD) to ensure CrM.
- Output OVP Sensing (120 % of V_{OUT} nominal).
- Steady-state operation voltage range is [1 V – 2.4 V].

Mode 2: FET ON

- Line OVP.

FEEDBACK (FB) Pin:

- FET current sensing using external current sense resistor.
- Normal operation voltage range is [$V_{FB(REF)} - 0 V$].

DRAIN (D) Pin:

High-voltage internal MOSFET.

SOURCE (S) Pin:

Power and signal ground.

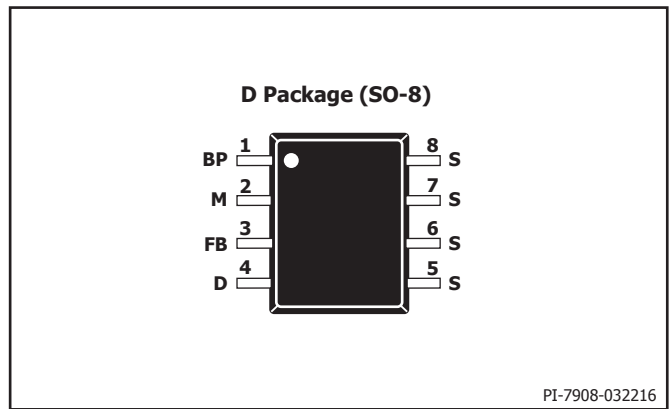

PI-7908-032216

Figure 4. Pin Configuration.

Applications Design Example

Wide Input 8 W Bulb Driver Accurate Regulation, High Power Factor, Low ATHD Design Example (RDK-464)

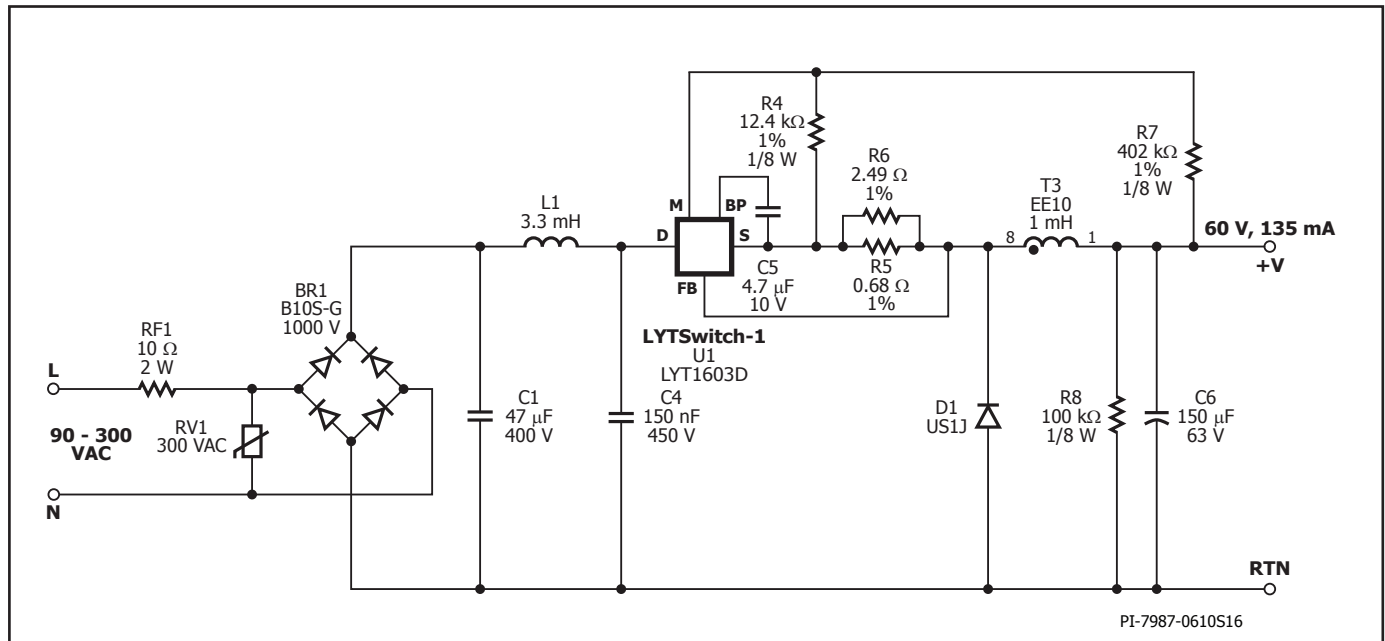

Figure 5. Schematic from RDK-464 8 W, 60 V, 135 mA, Non-isolated A19 LED Driver for Wide Input Range: 90 – 300 V VAC using LYT1603D in High-Side Buck Configuration.

The circuit shown in Figure 5 is configured as high-side buck power supply utilizing the LYT1603D from the LYTSwitch-1 family of ICs. This is a low-cost LED driver designed to drive a 60 V LED voltage string at 135 mA output current with an input voltage range of 90 VAC to 300 VAC.

Circuit Description

LYTSwitch-1 is a SO-8 package LED driver controller IC designed for non-isolated buck topology applications. The LYTSwitch-1 provides high efficiency, high power factor and accurate LED current regulation. It incorporates a high-voltage 725 V power MOSFET and a control engine to switch the FET in critical conduction mode with variable frequency and variable on-time for low EMI, accurate current regulation, high power factor, low THD and high efficiency. The controller also integrates protection features such as input and output overvoltage protection, thermal fold-back, over-temperature shutdown, output short-circuit and over-current protection.

Input Stage

The input fusible resistor RF1 provides safety protection and also serves as a current limiting component against high-voltage differential surge. Varistor RV1 acts as a voltage clamp that limits the voltage spike on the primary during line transient voltage surge events. A 300 VAC rated part was selected with a maximum clamping voltage specification of 710 VDC lower than the device drain voltage (725 V). The AC input voltage is full wave rectified by BR1 to achieve good power factor and low THD. For higher surge capability such as >1 kV, C1 and L1 can be placed before the bridge rectifier BR1 in the same order and RV1 after BR1 but, a safety X-capacitor is required to be used for C1.

The rectified AC supply through BR1 is filtered by the input capacitors C1 and C4. Too much capacitance degrades power factor and THD, so the values of the input capacitors were adjusted to the minimum values necessary to meet EMI with a suitable margin. Inductor L1, C1 and C4 form a π (pi) filter, which attenuates conducted differential and common mode EMI currents. A resistor of at least 10 k Ω (not shown) across L1 can be used damp the Q-factor of the filter inductor to improve filtering high frequency EMI without reducing low frequency attenuation.

LYTSwitch-1 Controller Stage

The LED driver circuit is a high-side buck configuration operating in critical condition mode. During the time the internal MOSFET is on, current ramps up through inductor T3, storing energy in the magnetic field and at the same time supplying current to the load. Then when the internal MOSFET turns off, the current will continue to flow in the same direction ramping down, to the output load via flywheel diode D1.

Capacitor C5 provides local decoupling for the BYPASS (BP) pin of LYTSwitch-1 IC, which provides power to the controller during the switch on time. The IC internal regulator draws power from the high-voltage DRAIN (D) pin and charges the bypass capacitor C5 during the power switch off-time. The typical BYPASS pin voltage is 5.22 V. To keep the IC operating normally especially during the dead zone, where $V_{IN} < V_{OUT}$, the value of the capacitor should be large enough to keep the bypass voltage above the $V_{BP(RESET)}$ reset value of 4.5 V. Recommended minimum value for the bypass capacitor is 4.7 μ F, X7R if using a ceramic type capacitor.

Constant output current regulation is achieved through the FEED-BACK (FB) pin directly sensing the drain current during the FET on-time using external current sense resistors (R_{FB}) R5 and R6 and comparing the voltage drop to a fixed internal reference voltage ($V_{FB(REF)}$) of absolute value 279 mV typical. R_{FB} can be estimated by the given equation;

$$R_{FB} = V_{FB(REF)} / k \times I_{OUT}$$

Where: k is the ratio between I_{PK} and I_{OUT} ; such that k = 3 for LYT-14xx, and k = 3.6 for LYT-16xx)

Trimming R_{FB} may be necessary to center I_{OUT} at the nominal output LED voltage.

The MULTIFUNCTION (M) pin monitors the line for any line overvoltage event. When the internal MOSFET is in on-state, the MULTIFUNCTION pin is shorted internally to the SOURCE (S) pin in order to detect the rectified input line voltage derived for the voltage across the inductor, i.e. ($V_{IN} - V_{OUT}$) and current flowing out of the MULTIFUNCTION pin is defined by resistor R7, thus the line over voltage detection is calculated as follows;

$$V_{LINE(OVP)} = I_{IOV} \times R7 + V_{OUT}$$

Where: R7 is assumed to be 402 k Ω \pm 1%.

Once the detected current exceeds the input overvoltage threshold (I_{IOV}) of 1 mA typical, the IC will inhibit switching instantaneously and initiate auto-restart to protect the internal MOSFET of the IC.

The MULTIFUNCTION (M) pin also monitors the output for any overvoltage and undervoltage event. When the internal MOSFET is in off-state, the output voltage is sensed via divider resistors R4 and R7 across the inductor voltage of T3. When an output open-load condition occurs, the voltage at the MULTIFUNCTION pin will rise abruptly and when it exceeds the V_{OOV} threshold of 2.4 V typical, the IC will inhibit switching and initiate auto-restart to limit the output voltage from further rising. The overvoltage cut-off is typically set to 120% of the output voltage, which is equivalent to 2 V target at the MULTIFUNCTION pin ($V_{OUT(OVP)} = V_{OUT} \times 2.4 V / 2 V$). If desired, higher overvoltage cut-off can be set with lower MULTIFUNCTION pin voltage target. Resistor R7 is set to a fixed value of 402 k Ω \pm 1% and R4 will determine the output overvoltage limit. Any output short-circuit at the output will be detected once the MULTIFUNCTION pin voltage falls below the undervoltage threshold (V_{OUV}) of 1 V typical, then the IC will inhibit switching and initiate auto-restart to limit the average input power of less than 1 W, preventing any component from overheating.

R4 can be calculated as follows;

$$R4 = 2 V \times R7 / (V_{OUT} - 2 V)$$

This is also applicable to Low-Side Configuration Buck topology (see application note AN-67).

Another function of the MULTIFUNCTION (M) pin is for zero current detection (ZCD). This is to ensure operation in critical conduction mode. The inductor demagnetization is sensed when the voltage across the inductor begins to collapse towards zero as flywheel diode (D1) conduction expires.

Output Stage

During the switching off-state, free-wheeling diode D1 rectifies the voltage across T3 and the output filtered by C6. An ultrafast 1 A, 600 V with 75 ns reverse recovery time (t_{RR}) diode was selected for efficiency and good regulation. The value of the output capacitor C8 was selected to give peak-to-peak LED ripple current equal to 30% of the mean value. For designs where lower ripple is desirable, the output capacitance value can be increased.

A small output pre-load resistor R8 discharges the output capacitor when the driver is turned off, giving a relatively quick and smooth decay of the LED light. Recommended pre-load power dissipation is \leq 0.5% of the output power.

Key Design Considerations

Device Selection

The data sheet power table (Table 2) represents the maximum practical continuous output power that can be delivered in an open frame design with adequate heat sinking.

RDK-464 is a universal input 8 W driver for bulb application, where the operating temperature is high and a relatively low THD less than 25% is desired for universal input application. LYT1603D was chosen based on these conditions.

Output Power Table

Product	Optimized for Smallest Components	
	$V_{OUT} \leq 30 V$	$45 V \leq V_{OUT} \leq 55 V$
LYT1402D	4.0 W	8.0 W
LYT1403D	7.5 W	15 W
LYT1404D	11 W	22 W
Product	Optimized for Lowest THD	
	$V_{OUT} \leq 30 V$	$V_{OUT} \geq 55 V$
LYT1602D	4.0 W	8.0 W
LYT1603D	7.5 W	15 W
LYT1604D	11 W	22 W

Table 2. Output Power Table.

Magnetic Selection

The core is a small size EE10 with ferrite core material and open winding window that allowed better convection cooling for the winding.

To ensure proper magnetic design and accurate output current regulation, it is recommended that the LYTSwitch-1 PIXIs spreadsheet located at PI Expert web site (<https://piexpertonline.power.com/site/login>) should be used for magnetic calculations.

EMI Considerations

Total input capacitance affects PF and THD – increasing the value will degrade performance. LYTSwitch-1’s control engine allows operating in critical conduction mode with variable frequency and variable on-time provides low EMI and enables the use of small and simple pi (π) filter. It also allows simple magnetic construction where the main winding can be wound continuously using the automated winding approach preferred for low-cost manufacturing. The recommended location of the EMI filter is after the bridge rectifier. This allows the use of regular film capacitors as opposed to more expensive safety rated X-capacitors that would be required if the filter is placed before the bridge.

Thermal and Lifetime Considerations

Lighting applications present thermal challenges to the driver. In many cases the LED load dissipation determines the working ambient temperature experienced by the drive. Thermal evaluation should be performed with the driver inside the final enclosure. Temperature has a direct impact on driver and LED lifetime. For every 10 $^{\circ}C$ rise in temperature, component life is reduced by a factor of 2. Therefore, it is important to verify and optimize the operating temperatures of all components.

PCB Layout Considerations

In Figure 6, the EMI filter components should be located close together to improve filter effectiveness. Place the EMI filter components C1 and L1 as far away as possible from any switching nodes on the circuit board especially U1 drain node, output diode (D1) and the transformer (T3).

Care should be taken in placing the components on the layout that are used for processing input signals for the feedback loop that any high frequency noise coupled to the signal pins of U1 may affect proper system operation. The critical components in RDK-464 are R4, R5, R6, R7 and C5. It is highly recommended that these components be placed very close to the pins of U1 (to minimize long traces which could serve as antenna) and far away as much as possible from any high-voltage and high current nodes in the circuit board to avoid noise coupling.

The bypass supply capacitor C5 should be placed directly across BYPASS pin and SOURCE pin of U1 for effective noise decoupling.

As shown in Figure 6, minimize the loop areas of the following switching circuit elements to lessen the creation of EMI.

- Loop area formed by the transformer winding (T3), free-wheeling rectifier diode (D1) and output capacitor (C6).
- Loop area formed by input capacitor (C4), U1 internal MOSFET, free-wheeling rectifier diode (D1) and sense resistor (R5).

LYTSwitch-1 Low-Side Configuration

In Figure 8, LYTSwitch-1 employs low-side Buck configuration and the ground potential SOURCE pins are used for heat sinking. This allows the designer to maximize the copper area for good thermal management but, without having the risk of increased EMI.



Figure 6. Design Example RDK-464 PCB Layout Showing the Critical Loop Areas with LYTSwitch-1 in High-Side Buck Configuration.



Figure 7. Schematic from DER-548 a 20 W, 120 V-170 mA Non-isolated LED Driver for Tube with High-line Input Range of 190 – 300 VAC using LYT1604D.



Figure 8. Design Example DER-548 PCB Layout Showing the Critical Components and Loop Areas with LYTSwitch-1 in Low-Side Buck Configuration.

Since the switch MOSFET is referenced to ground, the low-side buck configuration would also give an advantage of using a low-cost off-the-shelf dog bone type inductor as demonstrated in the design example DER-548. The addition of a small capacitor C4 (Figure 7) is needed to couple the high-voltage referenced signal of the output voltage into the MULTIFUNCTION pin of the IC through the resistor divider network R2, R3 and R5. Based on the simulation and bench results capacitance of 100 pF is a good compromise between AC line rejection and flatness of the output voltage during the off-time of the switch. Based on capacitance tolerance, 68 pF to 150 pF range can be used.

Design Tools

Up-to-date information on design tools can be found at the Power Integrations web site: www.power.com

LYTSwitch-1 PIXIs spreadsheet is located at PI Expert online: <https://piexpertonline.power.com/site/login>

Quick Design Checklist

Maximum Drain Voltage

Verify that the peak Drain voltage stress (VDS) does not exceed 725 V under all operating conditions, including start-up and fault conditions.

Maximum Drain Current

Measure the peak Drain current under all operation conditions (including start-up and fault conditions). Look for transformer saturation (usually occurs at highest operating ambient temperatures). Verify that the peak current is less than the stated Absolute Maximum Rating in the data sheet.

Thermal Check

At maximum output power, for both minimum and maximum line voltage and maximum ambient temperature verify that component's temperature specifications are not exceeded for the LYTSwitch-1, transformer, output diodes and output and input capacitors.

Absolute Maximum Ratings^(1,3)

DRAIN Pin Voltage:	LYT1x0x.....	-0.3 V to 725 V
DRAIN Pin Peak Current:	LYT1x02	1.05 A (1.3 A) ⁽¹⁾
	LYT1x03	2.1 A (2.6 A) ⁽¹⁾
	LYT1x04	2.8 A (3.5 A) ⁽¹⁾
BYPASS Pin Voltage	-0.3 V to 6.0 V
MULTIFUNCTION, FEEDBACK Pin Voltage.....		-0.45 V to 7.0 V ⁽²⁾
Lead Temperature		260 °C
Storage Temperature		-65 to 150 °C
Operating Junction Temperature.....		-40 to 150 °C ⁽⁴⁾

Notes:

1. The higher peak Drain current (in parentheses) is allowed while the Drain voltage is simultaneously less than 400 V for 725 V integrated MOSFET.
2. In case SOURCE pin is open, -0.7 V between FEEDBACK pin and SOURCE pin is observed with no degradation in performance.
3. The Absolute Maximum Ratings specified may be applied, one at a time without causing permanent damage to the product. Exposure to Absolute Maximum Ratings for extended periods of time may affect product reliability.
4. Normally limited by internal circuitry.

Thermal Resistance

Thermal Resistance: SO-8 Package:

(θ_{JA})	100 °C/W ⁽²⁾ , 80 °C/W ⁽³⁾
(θ_{JC}) ⁽¹⁾	30 °C/W

Notes:

1. Measured on the SOURCE pin close to plastic interface.
2. Soldered to 0.36 sq. inch (232 mm²) 2 oz. (610 g/m²) copper clad, with no external heat sink attached.
3. Soldered to 1 sq. in. (645 mm²), 2 oz, (610 g/m²) copper clad.

Parameter	Symbol	Conditions			Min	Typ	Max	Units
		SOURCE = 0 V T _J = -40 °C to 125 °C (Unless Otherwise Specified)						
Control Functions								
Minimum Switching Frequency	f _{MIN}			18	20	22		kHz
Maximum Switch ON-Time	T _{ON(MAX)}			37.5	40	45		µs
Minimum Switch ON-Time	T _{ON(MIN)}			1.012	1.1	1.25		µs
FEEDBACK Pin Reference Voltage	V _{FB(REF)}		T _J = 25 °C See Note C	-285	-279	-273		mV
Dead Zone Detect Threshold	V _{TH(DZ)}				0.3 × V _{FB(REF)}			V
Maximum Constant Current Zone	T _{CC(MAX)}				6			ms
Forced Minimum Constant Current Zone	T _{CC(MIN)}				1.2			ms
BYPASS Pin Supply Current	I _{SBY}	Standby (MOSFET not switching)				180		µA
	I _{DSS}	MOSFET Switching	LYT1x02		680			µA
			LYT1x03		785			
		LYT1x04		850				
BYPASS Pin Charge Current	I _{CH1}	V _{BP} = 0.0 V, V _{DS} ≥ 36 V			-10	-4.5		mA
	I _{CH2}	V _{BP} = 5.0 V, V _{DS} ≥ 36 V			-6	-2		mA
BYPASS Pin Voltage	V _{BP}			5.075	5.22	5.35		V

Parameter	Symbol	Conditions		Min	Typ	Max	Units
		SOURCE = 0 V T _J = -40 °C to 125 °C (Unless Otherwise Specified)					
Control Functions (cont.)							
BYPASS Pin Shunt Voltage	V _{BP(SHUNT)}			5.2	5.39	5.55	V
BYPASS Pin Power-Up Reset Threshold Voltage	V _{BP(RESET)}			4.35	4.5	4.65	V
Circuit Protection							
Current Limit for Auto-Restart	I _{LIMIT(AR)}	di/dt = 277 mA/μs T _J = 25 °C	LYT1x02	0.59	0.65	0.70	A
		di/dt = 446 mA/μs T _J = 25 °C	LYT1x03	1.06	1.15	1.24	
		di/dt = 662 mA/μs T _J = 25 °C	LYT1x04	1.61	1.75	1.88	
Fault Minimum Switch ON-Time	T _{FAULT(MIN)}				250	400	ns
Auto-Restart	T _{AR(OFF)1}	T _J = 25 °C			100		ms
	T _{AR(OFF)2}				1000		
Input Overvoltage Threshold	I _{IOV}	T _J = 25 °C		0.9	1.0	1.1	mA
MULTIFUNCTIONAL Pin Auto-Restart Threshold Voltage (Output OVP)	V _{OOV}	T _J = 25 °C		2.3	2.4	2.48	V
MULTIFUNCTIONAL Pin Undervoltage Threshold (Output Short)	V _{OUV}	T _J = 25 °C See Note B		0.91	0.95	0.99	V
Junction Temperature at Fold-Back	T _{FB}	See Note B		138	145	152	°C
Thermal Shutdown Temperature	T _{SD}	See Note A			160		°C
Thermal Shutdown Hysteresis	T _{SD(H)}	See Note A			75		°C

Parameter	Symbol	Conditions		Min	Typ	Max	Units
		SOURCE = 0 V T _J = -40 °C to 125 °C (Unless Otherwise Specified)					
Output							
ON-State Resistance	R _{DS(ON)}	LYT1x02 I _D = 91 mA	T _J = 25 °C		9.2	10.6	Ω
			T _J = 100 °C		14.0	16.1	
		LYT1x03 I _D = 139 mA	T _J = 25 °C		4.5	5.2	
			T _J = 100 °C		6.8	7.8	
		LYT1x04 I _D = 182 mA	T _J = 25 °C		3.4	3.9	
			T _J = 100 °C		5.1	5.8	
OFF-State Leakage	I _{DSS1}	V _{BP} = 5.25 V, V _{DS} = 580 V T _J = 125 °C	LYT1x02			40	μA
			LYT1x03			55	
			LYT1x04			70	
Breakdown Voltage	BV _{DSS}	LYT1x0x		725			V

NOTES:

- A. Guaranteed by design.
- B. This parameter is derived from characterization. Non-production test.
- C. All parts are individually trimmed in production to deliver the best CC accuracy.

Typical Performance Characteristics



Figure 1. DRAIN Pin Current vs. Drain Pin Voltage.

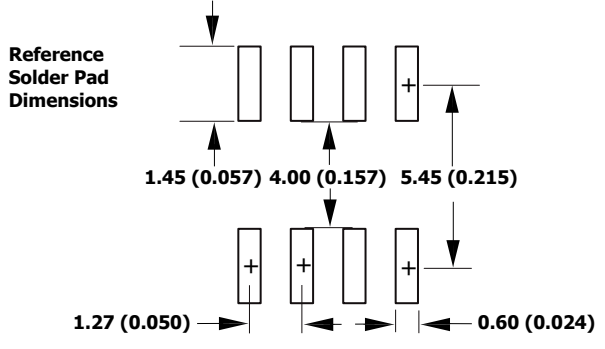
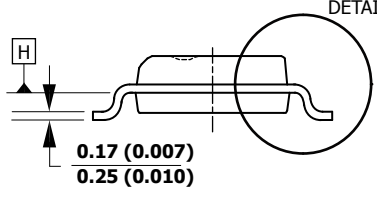
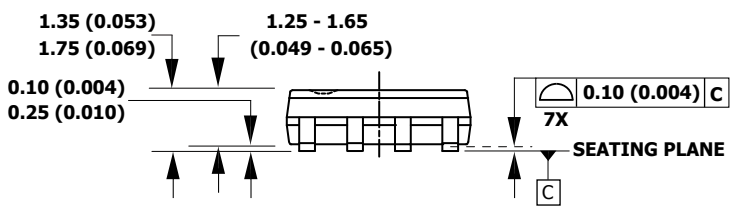
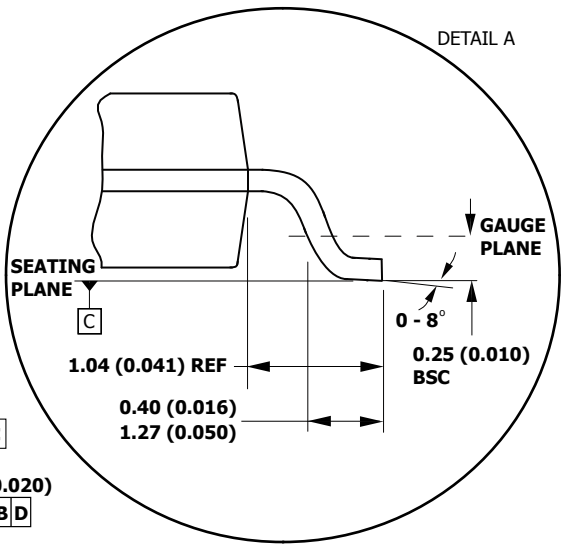
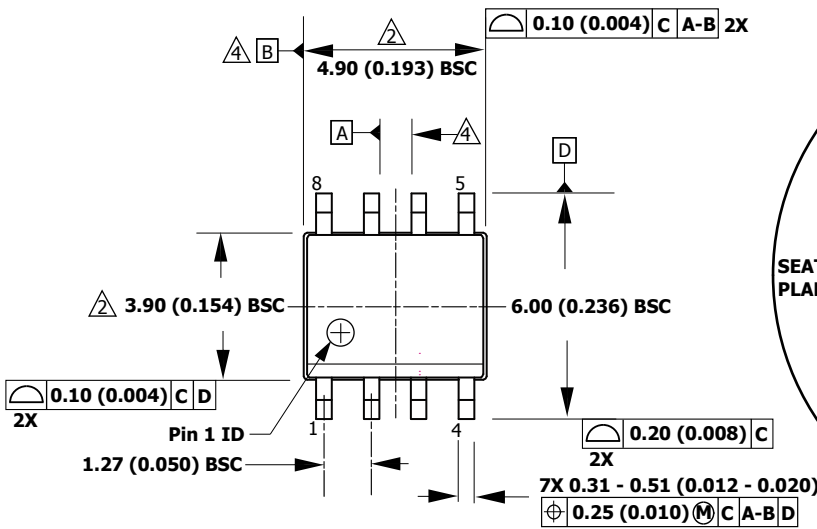

Figure 2. DRAIN Pin Capacitance vs. DRAIN Pin Voltage.



Figure 3. Maximum Allowable DRAIN Pin Current vs. DRAIN Pin Voltage.

SO-8 (D Package)



- Notes:**
1. JEDEC reference: MS-012.
 2. Package outline exclusive of mold flash and metal burr.
 3. Package outline inclusive of plating thickness.
 4. Datums A and B to be determined at datum plane H.
 5. Controlling dimensions are in millimeters. Inch dimensions are shown in parenthesis. Angles in degrees.

D08A

PI-5615-020515

MSL Table

Part Number	MSL Rating
LYT1402D	1
LYT1403D	1
LYT1404D	1
LYT1602D	1
LYT1603D	1
LYT1604D	1

ESD and Latch-Up Table

Test	Conditions	Results
Latch-up at 125 °C	JESD78D	> ±100 mA or > 1.5 × V(max) on all pins
Human Body Model ESD	ANSI/ESDA/JEDEC JS-001-2012	> ±2000 V on all pins
Machine Model ESD	JESD22-A115CA	> ±200 V on all pins
Charged Device Model ESD	JESD22-C101	> ±500 V on all pins

Part Ordering Information

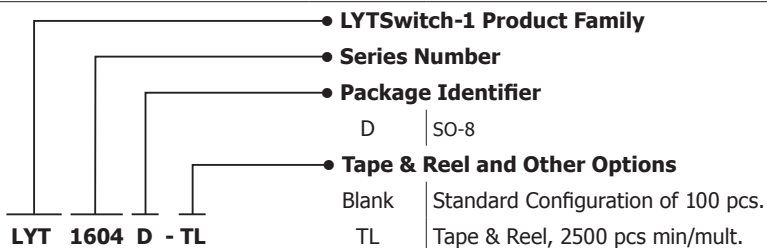

Notes

Revision	Notes	Date
A	Code S.	05/16
B	Code A. Updated TBD's in parameter table. Updated Typical values in $U_{FB(REF)}$, $T_{CC(MAX)}$, I_{DSS} , V_{OUV} parameters. Added Typical Performance Characteristics and Applications section.	07/16

For the latest updates, visit our website: www.power.com

Power Integrations reserves the right to make changes to its products at any time to improve reliability or manufacturability. Power Integrations does not assume any liability arising from the use of any device or circuit described herein. POWER INTEGRATIONS MAKES NO WARRANTY HEREIN AND SPECIFICALLY DISCLAIMS ALL WARRANTIES INCLUDING, WITHOUT LIMITATION, THE IMPLIED WARRANTIES OF MERCHANTABILITY, FITNESS FOR A PARTICULAR PURPOSE, AND NON-INFRINGEMENT OF THIRD PARTY RIGHTS.

Patent Information

The products and applications illustrated herein (including transformer construction and circuits external to the products) may be covered by one or more U.S. and foreign patents, or potentially by pending U.S. and foreign patent applications assigned to Power Integrations. A complete list of Power Integrations patents may be found at www.power.com. Power Integrations grants its customers a license under certain patent rights as set forth at <http://www.power.com/ip.htm>.

Life Support Policy

POWER INTEGRATIONS PRODUCTS ARE NOT AUTHORIZED FOR USE AS CRITICAL COMPONENTS IN LIFE SUPPORT DEVICES OR SYSTEMS WITHOUT THE EXPRESS WRITTEN APPROVAL OF THE PRESIDENT OF POWER INTEGRATIONS. As used herein:

1. A Life support device or system is one which, (i) is intended for surgical implant into the body, or (ii) supports or sustains life, and (iii) whose failure to perform, when properly used in accordance with instructions for use, can be reasonably expected to result in significant injury or death to the user.
2. A critical component is any component of a life support device or system whose failure to perform can be reasonably expected to cause the failure of the life support device or system, or to affect its safety or effectiveness.

The PI logo, TOPSwitch, TinySwitch, SENZero, SCALE-iDriver, Qspeed, PeakSwitch, LYTSwitch, LinkZero, LinkSwitch, InnoSwitch, HiperTFS, HiperPFS, HiperLCS, DPA-Switch, CAPZero, Clampless, EcoSmart, E-Shield, Filterfuse, FluxLink, StakFET, PI Expert and PI FACTS are trademarks of Power Integrations, Inc. Other trademarks are property of their respective companies. ©2016, Power Integrations, Inc.

Power Integrations Worldwide Sales Support Locations

World Headquarters

5245 Hellyer Avenue
San Jose, CA 95138, USA.
Main: +1-408-414-9200
Customer Service:
Phone: +1-408-414-9665
Fax: +1-408-414-9765
e-mail: usasales@power.com

China (Shanghai)

Rm 2410, Charity Plaza, No. 88
North Caoxi Road
Shanghai, PRC 200030
Phone: +86-21-6354-6323
Fax: +86-21-6354-6325
e-mail: chinasales@power.com

China (Shenzhen)

17/F, Hivac Building, No. 2, Keji Nan
8th Road, Nanshan District,
Shenzhen, China, 518057
Phone: +86-755-8672-8689
Fax: +86-755-8672-8690
e-mail: chinasales@power.com

Germany

Lindwurmstrasse 114
80337 Munich
Germany
Phone: +49-895-527-39110
Fax: +49-895-527-39200
e-mail: eurosales@power.com

Germany

HellwegForum 1
59469 Ense
Germany
Tel: +49-2938-64-39990
e-mail: igbt-driver.sales@power.com

India

#1, 14th Main Road
Vasanthanagar
Bangalore-560052 India
Phone: +91-80-4113-8020
Fax: +91-80-4113-8023
e-mail: indiasales@power.com

Italy

Via Milanese 20, 3rd. Fl.
20099 Sesto San Giovanni (MI) Italy
Phone: +39-024-550-8701
Fax: +39-028-928-6009
e-mail: eurosales@power.com

Japan

Kosei Dai-3 Bldg.
2-12-11, Shin-Yokohama,
Kohoku-ku
Yokohama-shi, Kanagawa
222-0033 Japan
Phone: +81-45-471-1021
Fax: +81-45-471-3717
e-mail: japansales@power.com

Korea

RM 602, 6FL
Korea City Air Terminal B/D, 159-6
Samsung-Dong, Kangnam-Gu,
Seoul, 135-728, Korea
Phone: +82-2-2016-6610
Fax: +82-2-2016-6630
e-mail: koreasales@power.com

Singapore

51 Newton Road
#19-01/05 Goldhill Plaza
Singapore, 308900
Phone: +65-6358-2160
Fax: +65-6358-2015
e-mail: singaporesales@power.com

Taiwan

5F, No. 318, Nei Hu Rd., Sec. 1
Nei Hu Dist.
Taipei 11493, Taiwan R.O.C.
Phone: +886-2-2659-4570
Fax: +886-2-2659-4550
e-mail: taiwansales@power.com

UK

Cambridge Semiconductor,
a Power Integrations company
Westbrook Centre, Block 5, 2nd Floor
Milton Road
Cambridge CB4 1YG
Phone: +44 (0) 1223-446483
e-mail: eurosales@power.com