

GlobTek, Inc.
www.globtek.com
186 Veterans Drive,
Northvale, NJ 07647
Tel. (201) 784-1000
Fax (201) 784-0111

Drawing Title: GTM46101-1005-USB, Medical Power Supply, Efficiency Level: VI, Case Color/Style: GlobTek Black, Wall Plug-in, Regulated Switchmode AC-DC Power Supply AC Adaptor, Input Rating: 100-240V~, 50-60 Hz, Interchangeable Blades <http://en.globtek.com/interchangeable-blades.php>, Output Rating: 10W, 5V@2A, Output Configuration: N/A mm, N/A/4 Cond, N/A, Type "A" USB "JACK", integral to power supply enclosure, Ferrite: None, N/A, GT Cord # C0132, Pin Out: USB, Pin 1: (+), Pin 2: N/C, Pin 3: N/C, Pin 4: Com, Blades/Input Cord: (Order Separately), Approvals: South African EAC CAN ICES-3 FCC CE CB 60601-1 2MOPP CB CE cETLus ES60601 cETLus 60601-1 3rd China RoHS Double Insulation IP20 Level VI LPS CB RoHS S-Mark IEC/EN 60601-1 Ukraine WEEE cETLus 60950 RCM CCC India CB EN/IEC 60335-1 PSE

Model No. GTM46101-1005-USB

Part No./Ordering No. WR9QA2000USBNMEDR6B

Rev G

REVISION HISTORY

REV	DESCRIPTION	SUB	DATE	APPROVED
G	Update CCC, RoHS 2 to RoHS, Ukraine mark Remove label from deviation	QA	08/06/2018	QA
F1	Add NRCS to approvals	QA	07/21/2017	QA
F	Change gift box Qty to 210, Gift Box Size to 74*35*42 mm and change Master Carton Size to 544*375*151 mm	QA	07/14/2016	QA
E	Update label on the unit	QA	05/04/2016	QA
D	Revise pinout (Pins 2 and 3 are not shorted); Update Ukraine mark; Add BIS (India) approval: Add CCC approval.	bsiep	02/25/2016	QA
C	Revise label format to ISO15223 Type.	DR	12/11/2015	QA
B	Change gift box Size to 92*72*50mm, Master Carton Size to 484*380*228mm, Qty to 100	QA	08/06/2015	QA
A	Initial Release	sorec	05/21/2015	QA

In Addition to GlobTek Inc.'s renewed ISO9001:2008 - Quality Management System Certification, GlobTek Inc. is now certified to:

ISO13485:2003 - Medical Devices Quality Management System Certification
ISO14001:2004 - Environmental Management System Certification

ISO Certificates are available online at <http://www.globtek.com/iso-certificates/>

Customer Approval of Specification:

Please approve, sign and send back to GlobTek so we can complete order processing.
A delay in receipt of this form will delay delivery schedule.

Company Name:

Customer P/N:

Quote Number:

Date:

Authorized Representative Name:

Authorized Representative Signature:

The acceptance of this specification and use of the product described in this document indicates the acceptance and binding of the customer to Globtek terms and conditions, which supersede all other agreements, terms, and conditions (<http://en.globtek.com/terms-and-conditions/>).

Footnote:

GlobTek Inc. will not be liable for the safety and performance of these power supplies if unauthorized access and repair occurs. End user should consult applicable UL, CSA or EN standards for proper installation instruction.

Limitation of Use:

GlobTek product are not authorized for use as mission critical components in life support hazardous environment, nuclear or aircraft applications without prior written approval from the CEO of GlobTek Inc.

Contents of this document are subject to change without prior notice.

GTM46101-1005-USB, 10W, 5V@2A, Wall Plug-in, Regulated Switchmode AC-DC Power Supply AC Adaptor

PROPRIETARY INFORMATION

PROPRIETARY OF GLOBTEK, INC. ANY REPRODUCTION, DISCLOSURE OR USE OF THIS DRAWING, IN WHOLE OR IN PART, IS HEREBY PROHIBITED EXCEPT AS SPECIFIED IN WRITING BY GLOBTEK, INC.

Page 1 of 13

quest /08/20/2018 7:42:39 AM

GloTek, Inc. www.globtek.com 186 Veterans Drive, Northvale, NJ 07647 Tel. (201) 784-1000 Fax (201) 784-0111	Drawing Title: GTM46101-1005-USB, Medical Power Supply, Efficiency Level: VI, Case Color/Style: GlobTek Black, Wall Plug-in, Regulated Switchmode AC-DC Power Supply AC Adaptor, Input Rating: 100-240V~, 50-60 Hz, Interchangeable Blades http://en.globtek.com/interchangeable-blades.php , Output Rating: 10W, 5V@2A, Output Configuration: N/A mm, N/A/4 Cond, N/A, Type "A" USB "JACK", integral to power supply enclosure, Ferrite: None, N/A, GT Cord # C0132, Pin Out: USB, Pin 1: (+), Pin 2: N/C, Pin 3: N/C, Pin 4: Com, Blades/Input Cord: (Order Separately), Approvals: South African EAC CAN ICES-3 FCC CE CB 60601-1 2MOPP CB CE cETLus ES60601 cETLus 60601-1 3rd China RoHS Double Insulation IP20 Level VI LPS CB RoHS S-Mark IEC/EN 60601-1 Ukraine WEEE cETLus 60950 RCM CCC India CB EN/IEC 60335-1 PSE	
	Model No. GTM46101-1005-USB	
	Part No./Ordering No. WR9QA2000USBNMEDR6B	Rev G

POWER SUPPLY INFORMATION

TYPE: Wall Plug-in
TECHNOLOGY: Regulated Switchmode AC-DC Power Supply AC Adaptor
CASE COLOR: GlobTek Black
NAMEPLATE RATED INPUT: 100-240V~, 50-60 Hz, 0.3A
INPUT CONFIG: Interchangeable Blades
WATTS: 10.0
VOLTS OUT: 5
CURRENT OUT (Amps): 2
BLADE/CORD INCLUDED: None:
BLADE/CORD INSTALLED: None:
GROUNDING CONFIGURATION (F1) Class II / Double Insulated
EFFICIENCY LEVEL: VI
OUTPUT CONFIGURATION N/A mm, N/A/4 Cond, N/A, Type "A" USB "JACK", integral to power supply enclosure, Ferrite: None, N/A, GT Cord # C0132
CONNECTOR PIN OUT: USB, Pin 1: (+), Pin 2: N/C, Pin 3: N/C, Pin 4: Com
LABEL SPECS: ISO 15223 medical device compliant label,L-1470
PACK SPEC: Standard with USB Jack, Individually Box

Notes/Modifications/Customizations (notes in this section supersede the values shown in the standard spec):

DIMENSIONS ARE IN MM UNLESS SPECIFIED OTHERWISE.

GlobTek, Inc. www.globtek.com 186 Veterans Drive, Northvale, NJ 07647 Tel. (201) 784-1000 Fax (201) 784-0111	Drawing Title: GTM46101-1005-USB, Medical Power Supply, Efficiency Level: VI, Case Color/Style: GlobTek Black, Wall Plug-in, Regulated Switchmode AC-DC Power Supply AC Adaptor, Input Rating: 100-240V~, 50-60 Hz, Interchangeable Blades http://en.globtek.com/interchangeable-blades.php , Output Rating: 10W, 5V@2A, Output Configuration: N/A mm, N/A/4 Cond, N/A, Type "A" USB "JACK", integral to power supply enclosure, Ferrite: None, N/A, GT Cord # C0132, Pin Out: USB, Pin 1: (+), Pin 2: N/C, Pin 3: N/C, Pin 4: Com, Blades/Input Cord: (Order Separately), Approvals: South African EAC CAN ICES-3 FCC CE CB 60601-1 2MOPP CB CE cETLus ES60601 cETLus 60601-1 3rd China RoHS Double Insulation IP20 Level VI LPS CB RoHS S-Mark IEC/EN 60601-1 Ukraine WEEE cETLus 60950 RCM CCC India CB EN/IEC 60335-1 PSE	
	Model No. GTM46101-1005-USB	
	Part No./Ordering No. WR9QA2000USBNMEDR6B	Rev G

ELECTRICAL SPECIFICATIONS

A) ELECTRICAL SPECIFICATIONS:

1. Input Voltage: Specified 90-264 Vac, Nameplate rated 100-240 Vac
2. Input Frequency: Specified 47-63 Hz, Nameplate rated 50-60 Hz
3. Output Regulation: +/- 5% measured at the end of a 1.2 meter USB cordset employing #20 Gauge conductors (RFP RFI-50856)
The longest cable GlobTek recommends to be used with this product is USB cord GlobTek PN USBA1M2MICROB20(R), 1.2 Meters for best voltage regulation performance. (RFP RFI-20435-3)
4. Line Voltage Regulation: +/- 3% typical measured at the end of a 1.2 meter USB cordset employing #20 Gauge conductors
5. Output Ripple (Vp-p): 150mV Ripples shall be measured with a 47uF electrolytic capacitor paralleled with a high-frequency 0.1uF ceramic capacitor across the output. The oscilloscope's bandwidth shall be set to 20MHz.
6. Turn-On/Turn-Off Overshoot: 5% maximum, 500 us maximum recovery time for 25% step load.
7. Turn-On Delay: 3000mS MAX at 115VAC Full Load
8. Hold-Up Time: 8mS Min at 100VAC Full Load
9. Inrush Current: No damage. On power when switching on/off repeatedly under any condition.
10. Switching Frequency: 66.5 KHz typical
11. Average Efficiency: 78.7% Min.(CEC&DOE Level VI Compliant), 79.0% Min. (ErP **European** Commission's Ecodesign Directive (2005/32/EC) / CoC Tier 2 Compliant)
12. Input Power(no load): < 0.1W < 0.1W, < 0.075W (ErP **European** Commission's Ecodesign Directive (2005/32/EC) / CoC Tier 2 Compliant)

B) PROTECTION

1. Over-Voltage: Output shut down and auto restart 110% to 140% of Vnom
2. Over Temperature Protection: Output shut down and auto restart
3. Short Circuit Protection Output shut down and auto restart
- 4 Over Load Protection Output shut down and auto restart 110% to 150% of Inom
5. Input Protection: Input line fusing
6. ESD: 8 kV Contact/20kV Air Discharge

C) SAFETY

1. Dielectric Withstand Voltage: 4000Vac or 5656Vdc 10mA 1 minute
2. Earth Leakage Current: N/A for Class II units, there is no PE Ground pin, so Earth Leakage current is not measured
3. Touch Current: Maximum allowed values: 100uA NC(Normal condition) 500uA SFC(single fault condition)
4. Means of Protection: 2 x MOPP
5. ROHS 2: Complies with EU 2011/65/EU and China SJ/T 11363-2006

D) OTHER:

1. MTBF: 200,000 hours @ 25°C ambient temperature
2. Operating Temperature: 0°C to 40°C ambient temperature
3. Humidity: 0% to 95% relative humidity
4. Storage Temperature: -40°C to 80°C

E) ENCLOSURE

1. Housing: High impact plastic, 94V0 polycarbonate, non-vented
2. Markings: Label and/or Pad Printed and/or Molded in the case

GlobTek, Inc.
 www.globtek.com
 186 Veterans Drive,
 Northvale, NJ 07647
 Tel. (201) 784-1000
 Fax (201) 784-0111

Drawing Title: GTM46101-1005-USB, Medical Power Supply, Efficiency Level: VI, Case Color/Style: GlobTek Black, Wall Plug-in, Regulated Switchmode AC-DC Power Supply AC Adaptor, Input Rating: 100-240V~, 50-60 Hz, Interchangeable Blades <http://en.globtek.com/interchangeable-blades.php>, Output Rating: 10W, 5V@2A, Output Configuration: N/A mm, N/A/4 Cond, N/A, Type "A" USB "JACK", integral to power supply enclosure, Ferrite: None, N/A, GT Cord # C0132, Pin Out: USB, Pin 1: (+), Pin 2: N/C, Pin 3: N/C, Pin 4: Com, Blades/Input Cord: (Order Separately), Approvals: South African EAC CAN ICES-3 FCC CE CB 60601-1 2MOPP CB CE cETLus ES60601 cETLus 60601-1 3rd China RoHS Double Insulation IP20 Level VI LPS CB RoHS S-Mark IEC/EN 60601-1 Ukraine WEEE cETLus 60950 RCM CCC India CB EN/IEC 60335-1 PSE

Model No. GTM46101-1005-USB

Part No./Ordering No. WR9QA2000USBNMEDR6B

Rev G

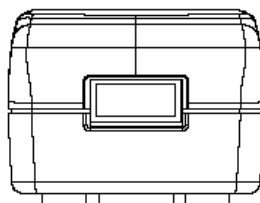
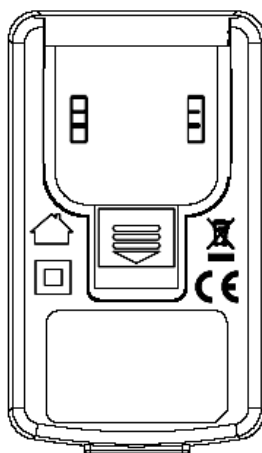
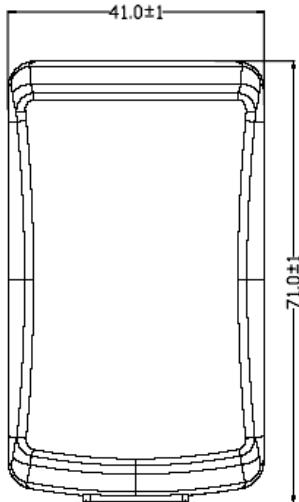
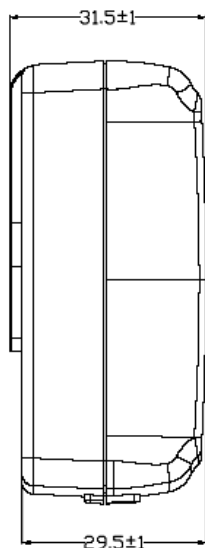

DERATING CURVE

GlobTek, Inc.
 www.globtek.com
 186 Veterans Drive,
 Northvale, NJ 07647
 Tel. (201) 784-1000
 Fax (201) 784-0111

Drawing Title: GTM46101-1005-USB, Medical Power Supply, Efficiency Level: VI, Case Color/Style: GlobTek Black, Wall Plug-in, Regulated Switchmode AC-DC Power Supply AC Adaptor, Input Rating: 100-240V~, 50-60 Hz, Interchangeable Blades <http://en.globtek.com/interchangeable-blades.php>, Output Rating: 10W, 5V@2A, Output Configuration: N/A mm, N/A/4 Cond, N/A, Type "A" USB "JACK", integral to power supply enclosure, Ferrite: None, N/A, GT Cord # C0132, Pin Out: USB, Pin 1: (+), Pin 2: N/C, Pin 3: N/C, Pin 4: Com, Blades/Input Cord: (Order Separately), Approvals: South African EAC CAN ICES-3 FCC CE CB 60601-1 2MOPP CB CE cETLus ES60601 cETLus 60601-1 3rd China RoHS Double Insulation IP20 Level VI LPS CB RoHS S-Mark IEC/EN 60601-1 Ukraine WEEE cETLus 60950 RCM CCC India CB EN/IEC 60335-1 PSE

Model No. GTM46101-1005-USB

Part No./Ordering No. WR9QA2000USBNMEDR6B

Rev G

Typical External Power Supply Derating Curve

(For Efficiency Level V and Efficiency Level VI Products)

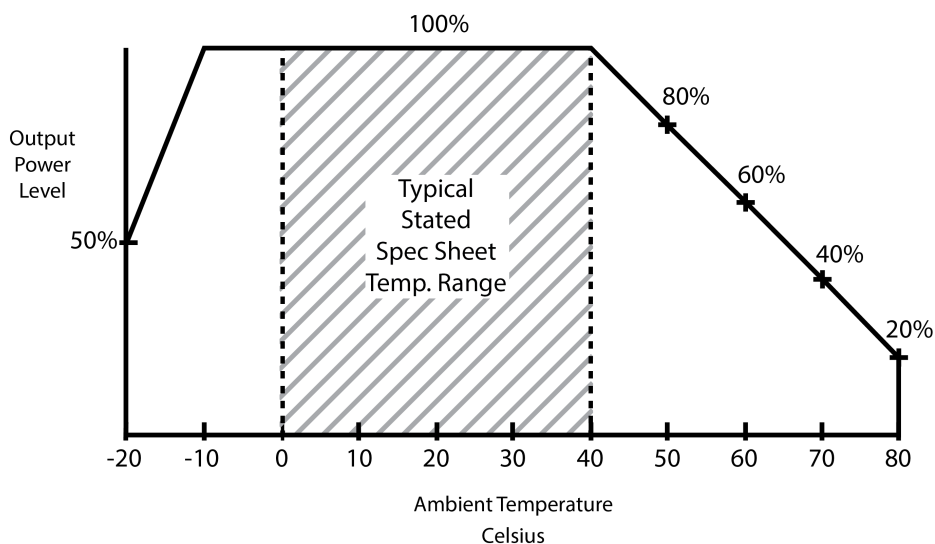

GlobTek, Inc.
 www.globtek.com
 186 Veterans Drive,
 Northvale, NJ 07647
 Tel. (201) 784-1000
 Fax (201) 784-0111

Drawing Title: GTM46101-1005-USB, Medical Power Supply, Efficiency Level: VI, Case Color/Style: GlobTek Black, Wall Plug-in, Regulated Switchmode AC-DC Power Supply AC Adaptor, Input Rating: 100-240V~, 50-60 Hz, Interchangeable Blades <http://en.globtek.com/interchangeable-blades.php>, Output Rating: 10W, 5V@2A, Output Configuration: N/A mm, N/A/4 Cond, N/A, Type "A" USB "JACK", integral to power supply enclosure, Ferrite: None, N/A, GT Cord # C0132, Pin Out: USB, Pin 1: (+), Pin 2: N/C, Pin 3: N/C, Pin 4: Com, Blades/Input Cord: (Order Separately), Approvals: South African EAC CAN ICES-3 FCC CE CB 60601-1 2MOPP CB CE cETLus ES60601 cETLus 60601-1 3rd China RoHS Double Insulation IP20 Level VI LPS CB RoHS S-Mark IEC/EN 60601-1 Ukraine WEEE cETLus 60950 RCM CCC India CB EN/IEC 60335-1 PSE

Model No. GTM46101-1005-USB

Part No./Ordering No. WR9QA2000USBNMEDR6B

Rev G

INPUT CONFIGURATION

Grounding Configuration:

Blades/Cord Included: None:

Blades/Cord Installed: None:

Blade Options for Q Series Wall Plug-in Power Supplies

Data Sheet: <http://en.globtek.com/interchangeable-blades.php>

Insertion Instructions: <http://www.globtek.com/pdf/Instructions-Interchangeable-Blades.pdf>

Video: [Q-Blade Style Instruction Video](#)

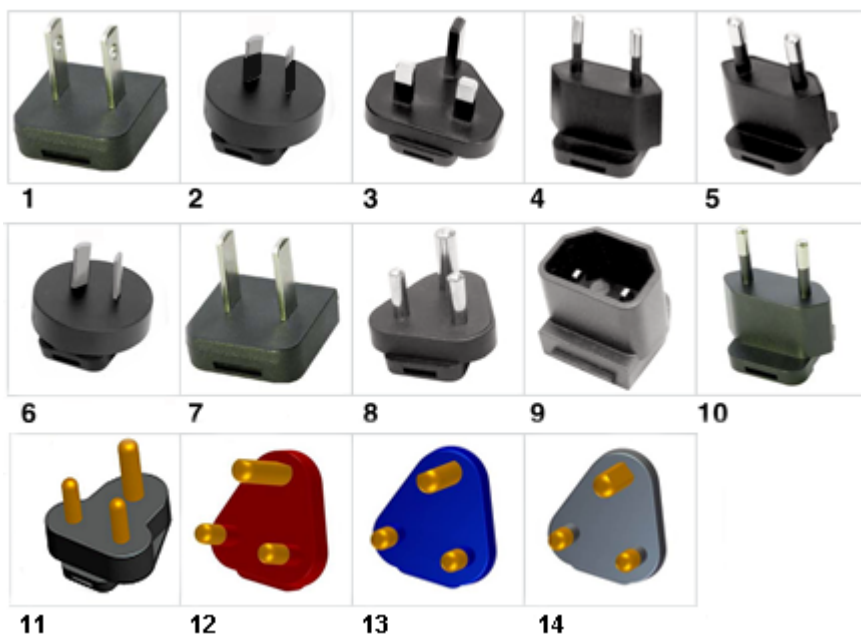

INPUT CONNECTOR: Q-Socket (below are available blades configurations which are "not included" (unless stated above); can be purchased separately, package with power supply or as a separate "Q-KIT" if specified

01. United States / Canada / Japan NEMA 1-15P configuration: NA 2 blades, Class II; US/CA/JP P/N: Q-NA(R)
02. Australian AS 3112 configuration: SAA 2 blade, Class II; AU P/N: Q-SAA(R)
03. UK BS 1363 configuration: UK 3 blade with dummy Ground, Class II; GB P/N: Q-UK(R)
04. European CEE 7/16 configuration: Europlug 2 pins, Class II; EU P/N: Q-EU(R)
05. Korean KS C8305 configuration: 2 pins, Class II; KR P/N: Q-KR(R)
06. Argentina IRAM 2073 configuration: 2 blades; AR P/N: Class II Q-AR(R)
07. China GB 2099 configuration: 2 blades, Class II; CN P/N: Q-CN(R)
08. India IS 1293 6A/BS546 configuration: 5A, 3 pins with Dummy Ground, Class II; IN P/N: Q-IN(R)
09. IEC320/C18 Inlet, Class II; P/N: Q-C18(R)
10. Brazilian NBR6147 configuration: 2 pins, Class II; BR P/N: Q-BR(R)
11. South Africa SABS164-1, 3 round prongs, Class II + dummy ground, P/N: Q-SANS164-1-16A(R)
12. South Africa SABS164-4, 3 round prongs with a notched prong @ 0°, Class II + dummy ground, Red, P/N: Q-SANS164-4L-16A(R)
13. South Africa SABS164-4, 3 round prongs with a notched prong @ -53°, Class II + dummy ground, Blue, P/N:

GloTek, Inc. www.globtek.com 186 Veterans Drive, Northvale, NJ 07647 Tel. (201) 784-1000 Fax (201) 784-0111	Drawing Title: GTM46101-1005-USB, Medical Power Supply, Efficiency Level: VI, Case Color/Style: GlobTek Black, Wall Plug-in, Regulated Switchmode AC-DC Power Supply AC Adaptor, Input Rating: 100-240V~, 50-60 Hz, Interchangeable Blades http://en.globtek.com/interchangeable-blades.php , Output Rating: 10W, 5V@2A, Output Configuration: N/A mm, N/A/4 Cond, N/A, Type "A" USB "JACK", integral to power supply enclosure, Ferrite: None, N/A, GT Cord # C0132, Pin Out: USB, Pin 1: (+), Pin 2: N/C, Pin 3: N/C, Pin 4: Com, Blades/Input Cord: (Order Separately), Approvals: South African EAC CAN ICES-3 FCC CE CB 60601-1 2MOPP CB CE cETLus ES60601 cETLus 60601-1 3rd China RoHS Double Insulation IP20 Level VI LPS CB RoHS S-Mark IEC/EN 60601-1 Ukraine WEEE cETLus 60950 RCM CCC India CB EN/IEC 60335-1 PSE	
	Model No. GTM46101-1005-USB	
	Part No./Ordering No. WR9QA2000USBNMEDR6B	Rev G

Q-SANS164-4C-16A(R)

14. South Africa SABS164-4, 3 round prongs with a notched prong @ +53°, Class II + dummy ground, Black, P/N:

Q-SANS164-4R-16A(R)

Kits

- 01. Q-KIT: 1,2,3,4 above
- 02. Q-KIT-INTL: 2,3,4 above
- 03. Q-KIT-6: 1,2,3,4,5,6 above
- 04. Q-KIT-7: 1,2,3,4,5,6,7 above
- 05. Q-KIT-8: 1,2,3,4,5,6,7,8 above

GlobTek, Inc.
 www.globtek.com
 186 Veterans Drive,
 Northvale, NJ 07647
 Tel. (201) 784-1000
 Fax (201) 784-0111

Drawing Title: GTM46101-1005-USB, Medical Power Supply, Efficiency Level: VI, Case Color/Style: GlobTek Black, Wall Plug-in, Regulated Switchmode AC-DC Power Supply AC Adaptor, Input Rating: 100-240V~, 50-60 Hz, Interchangeable Blades <http://en.globtek.com/interchangeable-blades.php>, Output Rating: 10W, 5V@2A, Output Configuration: N/A mm, N/A/4 Cond, N/A, Type "A" USB "JACK", integral to power supply enclosure, Ferrite: None, N/A, GT Cord # C0132, Pin Out: USB, Pin 1: (+), Pin 2: N/C, Pin 3: N/C, Pin 4: Com, Blades/Input Cord: (Order Separately), Approvals: South African EAC CAN ICES-3 FCC CE CB 60601-1 2MOPP CB CE cETLus ES60601 cETLus 60601-1 3rd China RoHS Double Insulation IP20 Level VI LPS CB RoHS S-Mark IEC/EN 60601-1 Ukraine WEEE cETLus 60950 RCM CCC India CB EN/IEC 60335-1 PSE

Model No. GTM46101-1005-USB

Part No./Ordering No. WR9QA2000USBNMEDR6B

Rev G

OUTPUT CORD AND CONNECTOR: USBMT/C0132

ACTUAL CONNECTORS, OVERMOLDS, FERRITES MAY VARY SLIGHTLY FROM THE PICTURE BELOW

CABLE TYPE	N/A
CABLE LENGTH (mm)	N/A
CABLE TOLERANCE (mm)	N/A
WIRE GAUGE (AWG)	N/A
CONDUCTORS	4
HANK DIMENSION (mm)	N/A
CABLE / CONNECTOR OVERMOLD COLOR	N/A
FERRITE TYPE / DIMENSION	None
FERRITE # OF TURNS (Definition)	N/A
FERRITE DIMENSION FROM STRAIN RELIEF	N/A
FERRITE DIMENSION FROM PLUG	N/A
PLUG TYPE	Type "A" USB "JACK", integral to power supply enclosure
OVER MOLD ORIENTATION	PCB Mount Connector
CONNECTOR PIN OUT:	USB, Pin 1: (+), Pin 2: N/C, Pin 3: N/C, Pin 4: Com
ADDITIONAL REQUIREMENTS	

Front View

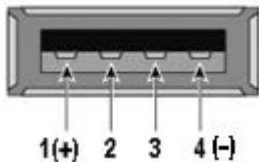

ADDITIONAL OUTPUT PLUG OPTIONS ARE AVAILABLE AT <http://www.globtek.com/connectors/>
 STANDARD PLUGS AND CONNECTORS CAN BE SEEN ONLINE AT <http://www.globtek.com/connectors/>

GlobTek, Inc.
 www.globtek.com
 186 Veterans Drive,
 Northvale, NJ 07647
 Tel. (201) 784-1000
 Fax (201) 784-0111

Drawing Title: GTM46101-1005-USB, Medical Power Supply, Efficiency Level: VI, Case Color/Style: GlobTek Black, Wall Plug-in, Regulated Switchmode AC-DC Power Supply AC Adaptor, Input Rating: 100-240V~, 50-60 Hz, Interchangeable Blades <http://en.globtek.com/interchangeable-blades.php>, Output Rating: 10W, 5V@2A, Output Configuration: N/A mm, N/A/4 Cond, N/A, Type "A" USB "JACK", integral to power supply enclosure, Ferrite: None, N/A, GT Cord # C0132, Pin Out: USB, Pin 1: (+), Pin 2: N/C, Pin 3: N/C, Pin 4: Com, Blades/Input Cord: (Order Separately), Approvals: South African EAC CAN ICES-3 FCC CE CB 60601-1 2MOPP CB CE cETLus ES60601 cETLus 60601-1 3rd China RoHS Double Insulation IP20 Level VI LPS CB RoHS S-Mark IEC/EN 60601-1 Ukraine WEEE cETLus 60950 RCM CCC India CB EN/IEC 60335-1 PSE

Model No. GTM46101-1005-USB

Part No./Ordering No. WR9QA2000USBNMEDR6B

Rev G

LABEL:L-1470

LABEL P/N: ISO 15223 medical device compliant label
 MATERIAL: Flat Thermal Transfer, Imprintable, Polyester Label and/or Pad Printed and/or Molded, and/or Laser Engraved in the case
 BACKGROUND COLOR: Black if housing is Black, White or Silver if housing is White or Gray.
 TEXT COLOR: White or Silver if label is Black Background for Black housing. Black if label is White or Silver background and Housing is White or Gray
 LABEL WIDTH (mm): 28.5
 LABEL HEIGHT (mm): 17.5

Below is the minimum information which will appear on the label. NOTE: in the logo area additional/actual positioning of symbols and text is subjected to change as per agency updates/requirements or additional model approvals become available. Agency logos may be in Regulatory Certifications/Label Markings area on the label or molded into the case housing outside the label area. Information will be shown via Label and/or Pad Printed and/or Molded in the case.



XXX = USA or CHINA

DATE CODE A *:

DATE CODE LABEL

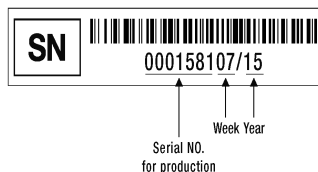

or

DATE CODE B *:

LOT WWYY
 WW = WEEK
 YY = YEAR

A=Medical Power Supply
 B=P/N: (料号) WR9QA2000USBNMEDR6B
 C=Model (型号) GTM46101-1005-USB
 D=Input (输入) 100-240V~, 50-60 Hz, 0.3A
 E=Output (输出) 5 V = 2 A, 10.0W

AGENCY ONLINE DOCUMENTS

<http://www.globtek.info/certs/GTM46101-10VV-X.X/>

GlobTek, Inc.
www.globtek.com
186 Veterans Drive,
Northvale, NJ 07647
Tel. (201) 784-1000
Fax (201) 784-0111

Drawing Title: GTM46101-1005-USB, Medical Power Supply, Efficiency Level: VI, Case Color/Style: GlobTek Black, Wall Plug-in, Regulated Switchmode AC-DC Power Supply AC Adaptor, Input Rating: 100-240V~, 50-60 Hz, Interchangeable Blades <http://en.globtek.com/interchangeable-blades.php>, Output Rating: 10W, 5V@2A, Output Configuration: N/A mm, N/A/4 Cond, N/A, Type "A" USB "JACK", integral to power supply enclosure, Ferrite: None, N/A, GT Cord # C0132, Pin Out: USB, Pin 1: (+), Pin 2: N/C, Pin 3: N/C, Pin 4: Com, Blades/Input Cord: (Order Separately), Approvals: South African EAC CAN ICES-3 FCC CE CB 60601-1 2MOPP CB CE cETLus ES60601 cETLus 60601-1 3rd China RoHS Double Insulation IP20 Level VI LPS CB RoHS S-Mark IEC/EN 60601-1 Ukraine WEEE cETLus 60950 RCM CCC India CB EN/IEC 60335-1 PSE

Model No. GTM46101-1005-USB

Part No./Ordering No. WR9QA2000USBNMEDR6B

Rev G

CE EC-Declaration for Medical

http://www.globtek.com/pdf/ec_declaration/a00a000000MEtdeEAD

CE EC-Declaration for Industrial/Commercial/ITE

[Contact GlobTek for more information](#)

RoHS/RoHS2 Declaration

http://www.globtek.com/pdf/rohs_cert/01ta0000005nZp4AAE

REACH Declaration

http://www.globtek.com/pdf/iso_certificates/REACH.pdf

Conflict Minerals Declaration

<http://www.globtek.com/pdf/conflict-minerals.pdf>

IPXY rating is based on 3rd party testing and customers should check suitability and test system level IPXY rating before ordering.

Regulatory Certifications/Label Markings

LATEST PRODUCT/MODEL CERTIFICATIONS: <http://en.globtek.com/datasheet/id/a00a000000MEtde>

AGENCY ONLINE DOCUMENTS:

<http://www.globtek.info/certs/GTM46101-10VV-X.X/>

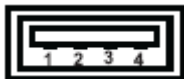

USB, Pin 1: (+), Pin 2: N/C, Pin 3: N/C, Pin 4: Com

GlobTek, Inc.
 www.globtek.com
 186 Veterans Drive,
 Northvale, NJ 07647
 Tel. (201) 784-1000
 Fax (201) 784-0111

Drawing Title: GTM46101-1005-USB, Medical Power Supply, Efficiency Level: VI, Case Color/Style: GlobTek Black, Wall Plug-in, Regulated Switchmode AC-DC Power Supply AC Adaptor, Input Rating: 100-240V~, 50-60 Hz, Interchangeable Blades <http://en.globtek.com/interchangeable-blades.php>, Output Rating: 10W, 5V@2A, Output Configuration: N/A mm, N/A/4 Cond, N/A, Type "A" USB "JACK", integral to power supply enclosure, Ferrite: None, N/A, GT Cord # C0132, Pin Out: USB, Pin 1: (+), Pin 2: N/C, Pin 3: N/C, Pin 4: Com, Blades/Input Cord: (Order Separately), Approvals: South African EAC CAN ICES-3 FCC CE CB 60601-1 2MOPP CB CE cETLus ES60601 cETLus 60601-1 3rd China RoHS Double Insulation IP20 Level VI LPS CB RoHS S-Mark IEC/EN 60601-1 Ukraine WEEE cETLus 60950 RCM CCC India CB EN/IEC 60335-1 PSE

Model No. GTM46101-1005-USB

Part No./Ordering No. WR9QA2000USBNMEDR6B

Rev G

PACKAGING

Packing Spec P/N:	Standard with USB Jack, Individually Box
Box Qty:	210
Gift Box Size (mm):	74*35*42
Gift Box Color:	White
Master Carton Size (mm):	544*375*151
Master GW (Kg):	14.8 kg
BLADES INCLUDED:	None:
BLADE/CORD INSTALLED:	None:

If specific packaging is required, this section must specify all requirements and note "no exceptions". If this section does not specify packaging, it is subject to change without notice at GlobTek's discretion

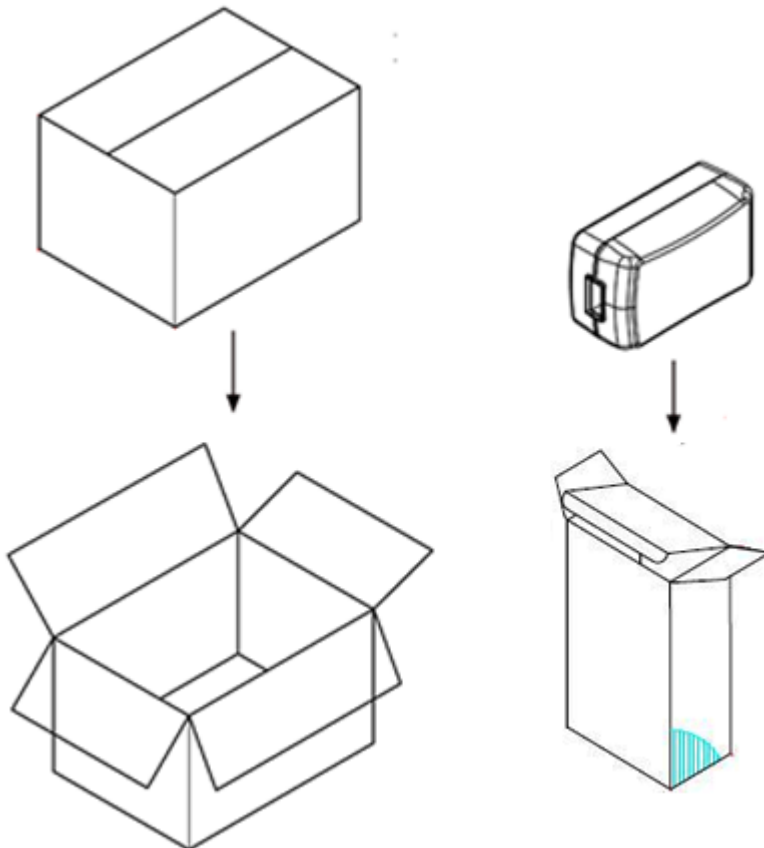

GloTek, Inc. www.globtek.com 186 Veterans Drive, Northvale, NJ 07647 Tel. (201) 784-1000 Fax (201) 784-0111	Drawing Title: GTM46101-1005-USB, Medical Power Supply, Efficiency Level: VI, Case Color/Style: GlobTek Black, Wall Plug-in, Regulated Switchmode AC-DC Power Supply AC Adaptor, Input Rating: 100-240V~, 50-60 Hz, Interchangeable Blades http://en.globtek.com/interchangeable-blades.php , Output Rating: 10W, 5V@2A, Output Configuration: N/A mm, N/A/4 Cond, N/A, Type "A" USB "JACK", integral to power supply enclosure, Ferrite: None, N/A, GT Cord # C0132, Pin Out: USB, Pin 1: (+), Pin 2: N/C, Pin 3: N/C, Pin 4: Com, Blades/Input Cord: (Order Separately), Approvals: South African EAC CAN ICES-3 FCC CE CB 60601-1 2MOPP CB CE cETLus ES60601 cETLus 60601-1 3rd China RoHS Double Insulation IP20 Level VI LPS CB RoHS S-Mark IEC/EN 60601-1 Ukraine WEEE cETLus 60950 RCM CCC India CB EN/IEC 60335-1 PSE	
	Model No. GTM46101-1005-USB	
	Part No./Ordering No. WR9QA2000USBNMEDR6B	Rev G

INSTRUCTION SHEET

Q Blades Instruction Sheet (not required to be packaged with product)

Insertion Instructions: <http://www.globtek.com/pdf/Instructions-Interchangeable-Blades.pdf>

This manual is Provided to customer within the product specification - it is the responsibility of

the OEM/customer to provide the end system user instructions + warnings for the use of this product in the end system. By accepting this specification the customer/OEM Agrees to these terms.

USER MANUAL FOR Q-BLADE SERIES SWITCHING POWER SUPPLIES

Manual del Usuario. Fuentes de Alimentación Series Q-Blade

WARNING! RISK OF FIRE! SHOCK HAZARD!: To prevent electric shock, do not remove the cover. No user-serviceable parts inside. This unit contains hazardous voltages and should only be opened by a trained and qualified technician. Do not use if bent, cracked, modified or compromised. To avoid the possibility of electric shock, disconnect electric power to the product before connecting or disconnecting.

Advertencia! Riesgo de Fuego! Peligro de Choque eléctrico!

No contiene dentro componentes servibles para el usuario. Desconecte el cable de alimentación antes de quitar la cubierta.

INDOOR USE ONLY!

Únicamente para uso en el interior.

POWER SUPPLY BLADE/CORD: AC Mains voltage should be provided to the power supply by a power supply cords approved to

the national standards in which it will be used. Please use the below table as a guideline for Suitable Power cords.

CABLE DE ALIMENTACIÓN: El voltaje de la CA debe proporcionarse a la fuente de alimentación mediante

los cables de alimentación aprobados conforme a las normas nacionales según las cuales será utilizada. Utilice por favor la tabla mencionada aquí abajo como guía para los cables eléctricos adecuados.

1. Class II model NEMA 1-15P AC power plug with 2 prongs, Q-NA(R)
2. Australian AS 3112 configuration: SAA 2 pins Class II, Q-SAA(R)
3. UK BS 1363 configuration: UK 2 pins Class II, Q-UKY(R)
4. European CEE 7/16 configuration: Europlug 2 PINS, Class II, Q-EU(R)
5. Korean KS C8305 configuration: Q-KR(R)
6. Argentina IRAM 2073 configuration: 2 pins, Class II Q-AR(R)
7. China GR 2099 configuration: 2 pins, Class II Q-CN(R)
8. India configuration: 2 pins, Class II, Q-IN(R)
9. IEC320/C18 Inlet

FUSING: Internal fuse for Line is provided in the power supply. A blown internal fuse is an indication of catastrophic failure

GlobTek, Inc.
www.globtek.com
186 Veterans Drive,
Northvale, NJ 07647
Tel. (201) 784-1000
Fax (201) 784-0111

Drawing Title: GTM46101-1005-USB, Medical Power Supply, Efficiency Level: VI, Case Color/Style: GlobTek Black, Wall Plug-in, Regulated Switchmode AC-DC Power Supply AC Adaptor, Input Rating: 100-240V~, 50-60 Hz, Interchangeable Blades <http://en.globtek.com/interchangeable-blades.php>, Output Rating: 10W, 5V@2A, Output Configuration: N/A mm, N/A/4 Cond, N/A, Type "A" USB "JACK", integral to power supply enclosure, Ferrite: None, N/A, GT Cord # C0132, Pin Out: USB, Pin 1: (+), Pin 2: N/C, Pin 3: N/C, Pin 4: Com, Blades/Input Cord: (Order Separately), Approvals: South African EAC CAN ICES-3 FCC CE CB 60601-1 2MOPP CB CE cETLus ES60601 cETLus 60601-1 3rd China RoHS Double Insulation IP20 Level VI LPS CB RoHS S-Mark IEC/EN 60601-1 Ukraine WEEE cETLus 60950 RCM CCC India CB EN/IEC 60335-1 PSE

Model No. GTM46101-1005-USB

Part No./Ordering No. WR9QA2000USBNMEDR6B

Rev G

of circuit component(s). Repair must be performed by GlobTek, Inc. authorized personnel. Fuses must be replaced with same type and ratings per GlobTek internal documentation.

FUSIBLES: La fuente de alimentación provee un fusible interno para la línea. Un fusible interno quemado es un indicador de una falla catastrófica de los componentes del circuito. La reparación debe ser hecha por personal autorizado de GlobTek, Inc. Los fusibles se deben reemplazar por los mismos tipos y rangos que la documentación interna de GlobTek mencione.

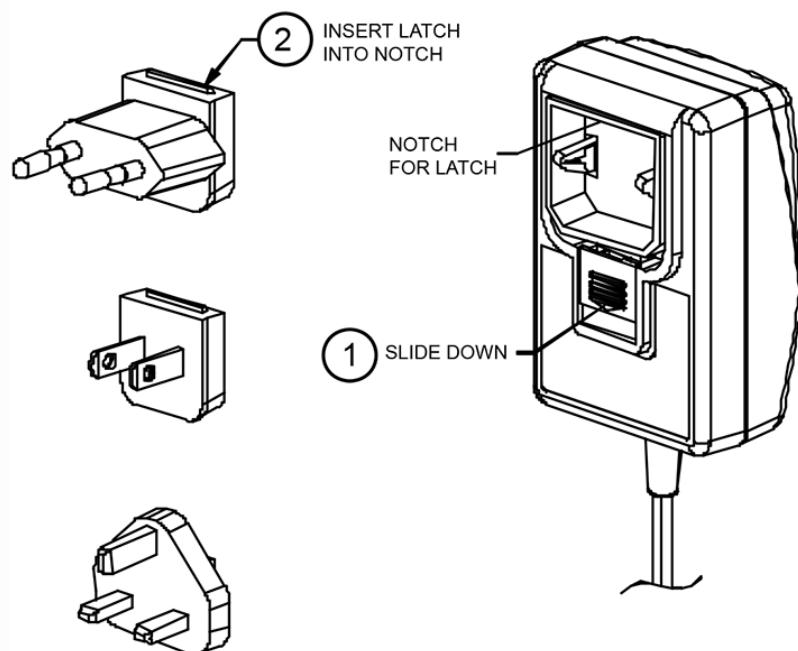

This symbol on an instrument indicates that the user should refer to the operating instructions located in the manual.