

CJ3139KDW-G (Dual P-Channel)

RoHS Device

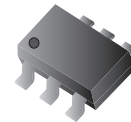

V(BR)DSS	RDS(on)MAX	ID
-20V	520mΩ @ -4.5V	-0.66A
	700mΩ @ -2.5V	
	950mΩ(TYP) @ -1.8V	

Features

- High-side switching
- Low on-resistance
- Low threshold
- Fast switching speed

Mechanical data

- Case: SOT-363, molded plastic.
- Terminals: Solderable per MIL-STD-750, method 2026.
- Weight: 0.006 grams (approx.)

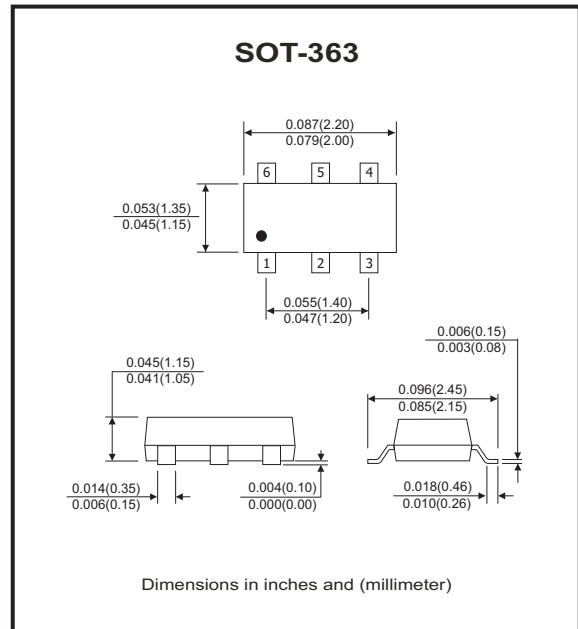

Circuit diagram

G : Gate
S : Source
D : Drain

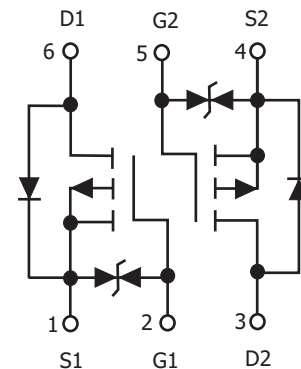

Maximum Ratings (at Ta=25 °C unless otherwise noted)

Parameter	Symbol	Value	Unit
Drain-source voltage	V _{DSS}	-20	V
Typ. Gate-source voltage	V _{GS}	±12	V
Drain current-Continuous	I _{D(DC)}	-0.66	A
Drain current-pulsed (note1)	I _{DM(pulse)}	-2.64	A
Power dissipation (note 2)	P _D	150	mW
Thermal resistance from junction to ambient	R _{θJA}	833	°C/W
Junction temperature range	T _J	-40 to +150	°C
Storage temperature range	T _{STG}	-55 to +150	°C

Electrical Characteristics (at TA=25°C unless otherwise noted)

Parameter	Symbol	Conditions	Min	Typ	Max	Unit
On/Off States						
Drain-source breakdown voltage	$V_{(BR)DSS}$	$V_{GS} = 0V, I_D = -250\mu A$	-20			V
Gate threshold voltage (note 3)	$V_{GS(th)}$	$V_{DS} = V_{GS}, I_D = -250\mu A$	-0.35		-1.1	V
Gate-body leakage current	I_{GSS}	$V_{GS} = \pm 10V, V_{DS} = 0V$			± 20	μA
Zero gate voltage drain current	I_{DSS}	$V_{DS} = -20V, V_{GS} = 0V$			-1	μA
Drain-source on-state resistance (note 3)	$R_{DS(on)}$	$V_{GS} = -4.5V, I_D = -1A$			520	m Ω
		$V_{GS} = -2.5V, I_D = -800mA$			700	
		$V_{GS} = -1.8V, I_D = -500mA$		950		
Forward transconductance	g_{fs}	$V_{DS} = -10V, I_D = -540mA$	0.8			S
Dynamic characteristics (note 4)						
Input capacitance	C_{iss}	$V_{DS} = -16V, V_{GS} = 0V$ $f=1MHz$			170	pF
Output capacitance	C_{oss}				25	
Reverse transfer capacitance	C_{rss}				15	
Switching time (note4)						
Turn-on delay time	$t_{d(on)}$	$V_{DD} = -10V, I_D = -200mA$ $V_{GS} = -4.5V, R_G = 10\Omega$		9		nS
Rise time	t_r			5.8		
Turn-off delay time	$t_{d(off)}$			32.7		
Fall time	t_f			20.3		
Drain-source diode characteristics						
Drain-source diode forward voltage (note 3)	V_{SD}	$I_S = -0.5A, V_{GS} = 0V$			-1.2	V

Notes:

1. Repetitive rating: Pulse width limited by maximum junction temperature.
2. This test is performed with no heat sink at Ta=25°C.
3. Pulse test: Pulse width≤300μs, Duty cycle≤0.5%.
4. These parameters have no way to verify.

RATING AND CHARACTERISTIC CURVES (CJ3139KDW-G)

Fig.1 - Output Characteristics

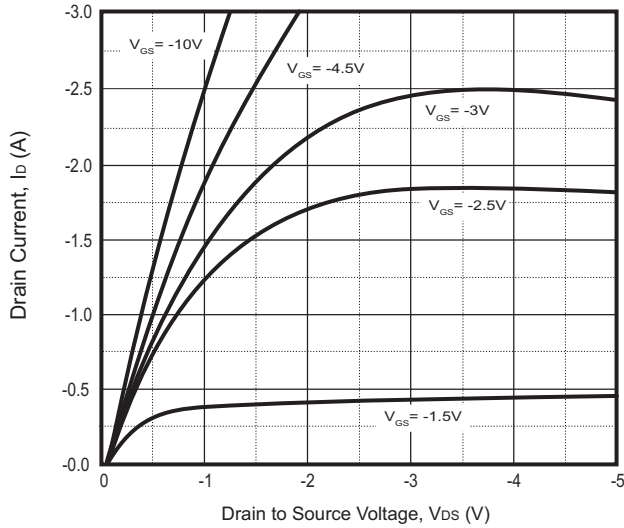

Fig.2 - Transfer Characteristics

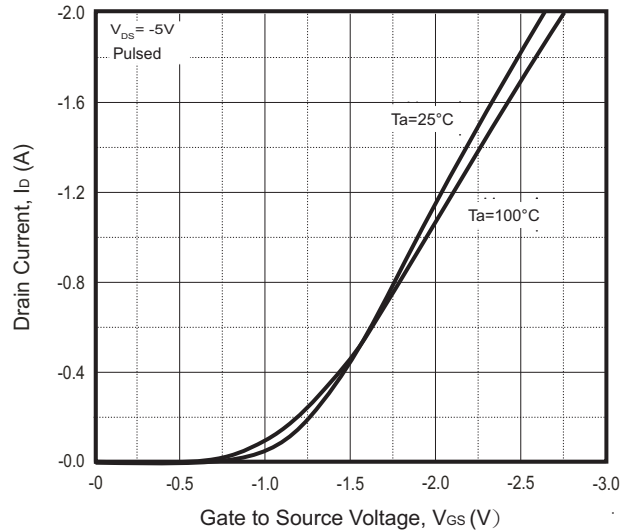

Fig.3 - $R_{DS(ON)}$ — I_D

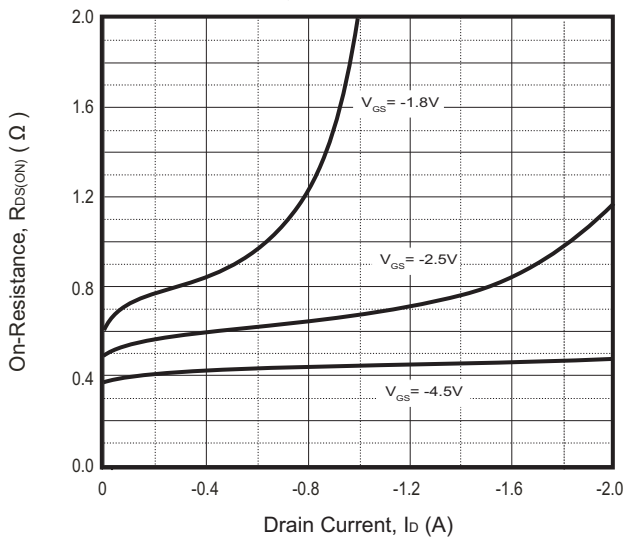

Fig.4 - $R_{DS(ON)}$ — V_{GS}

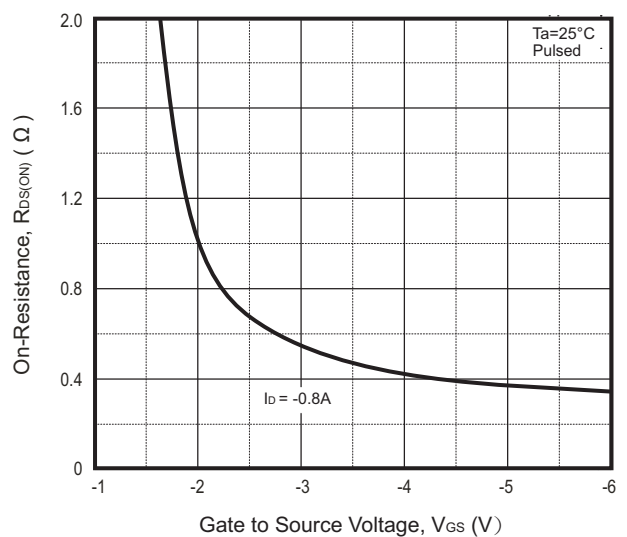

Fig.5 - I_S — V_{SD}

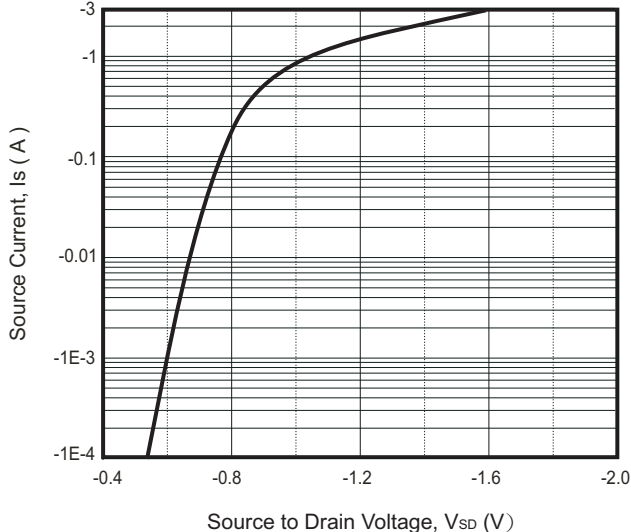
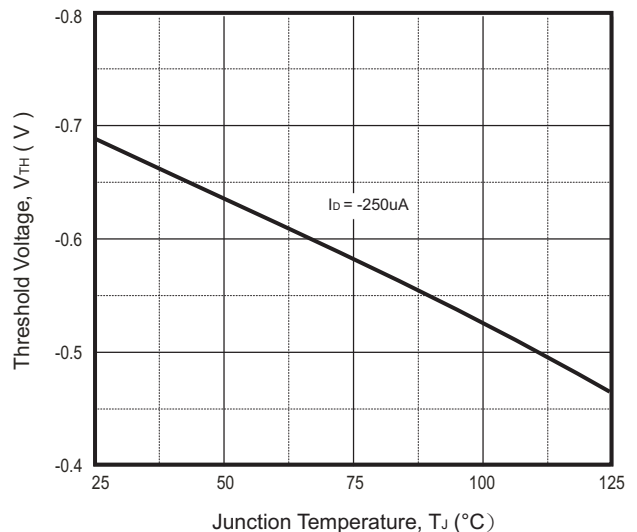
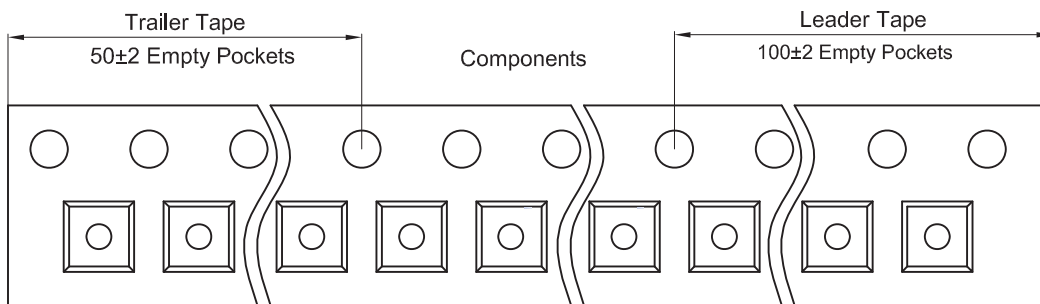
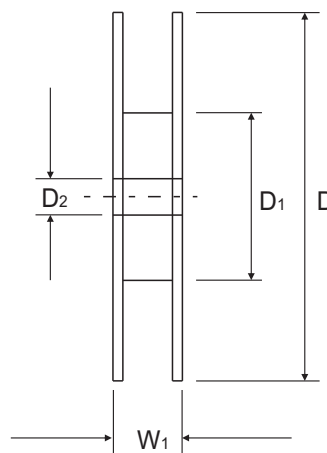
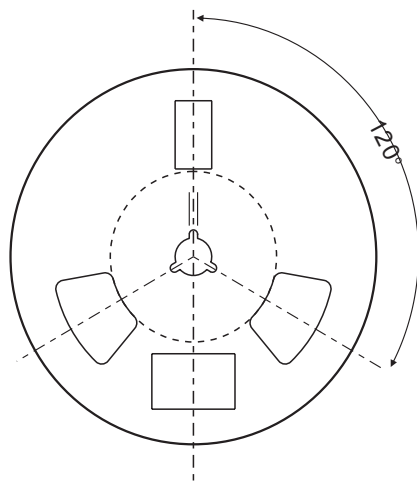
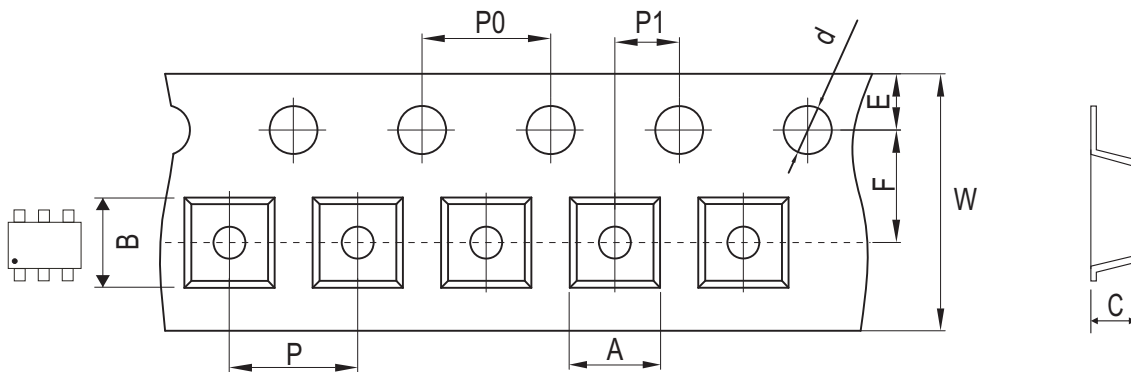

Fig.6 - Threshold Voltage



Reel Taping Specification



SOT-363	SYMBOL	A	B	C	d	D	D1	D2
	(mm)	2.25 ± 0.05	2.55 ± 0.05	1.20 ± 0.05	1.50 ± 0.10	178.00 ± 2.00	54.40 ± 1.00	13.00 ± 1.00
	(inch)	0.089 ± 0.002	0.100 ± 0.002	0.047 ± 0.002	0.059 ± 0.004	7.008 ± 0.079	2.142 ± 0.039	0.512 ± 0.039

SOT-363	SYMBOL	E	F	P	P0	P1	W	W1
	(mm)	1.75 ± 0.10	3.50 ± 0.10	4.00 ± 0.10	4.00 ± 0.10	2.00 ± 0.10	8.00 + 0.30/-0.10	12.30 ± 1.00
	(inch)	0.069 ± 0.004	0.138 ± 0.004	0.157 ± 0.004	0.157 ± 0.004	0.079 ± 0.004	0.315 + 0.012/-0.004	0.484 ± 0.039

Marking Code

Part Number	Marking Code
CJ3139KDW-G	39K

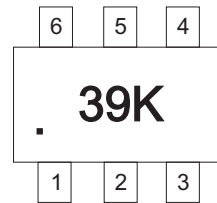

Suggested PAD Layout

SIZE	SOT-363	
	(mm)	(inch)
A	0.80	0.032
B	0.40	0.016
C	0.65	0.026
D	1.94	0.076
E	2.74	0.108

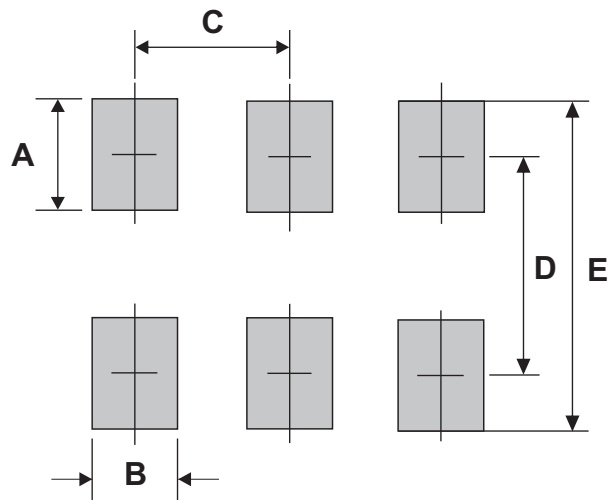

Standard Packaging

Case Type	REEL PACK	
	REEL (pcs)	Reel Size (inch)
SOT-363	3,000	7