

10 9 8 7 6 5 4 3 2 1

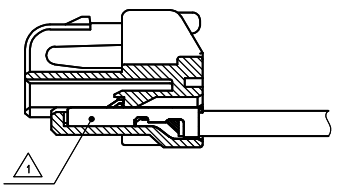

ターミナル装着図  
TERMINAL ASSEMBLY DRAWING

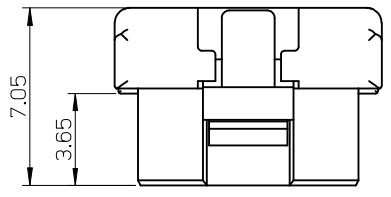
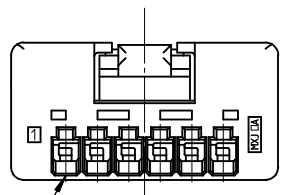
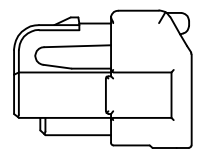
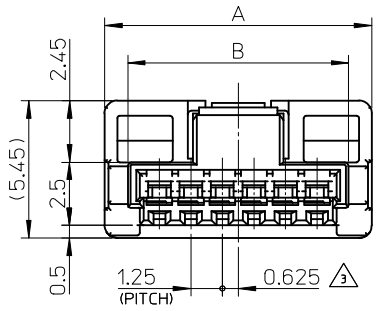

回路番号 1  
CKT NO. 1

NOTES

- ① 適合ターミナル: 502381-00\*\*  
APPLICABLE TARMINAL: 502381-00\*\*
- 2. 嵌合相手: 502382-\*\*09 / 502386-\*\*09  
MATE WITH: 502382-\*\*09 / 502386-\*\*09
- ③ 極数/コ=偶数に適用。  
APPLY FOR CKT. SIZE / 2 = EVEN.
- 4. 本製品のプラスチック部に黒点等が確認される場合や色合いが異なる場合がありますが、製品性能に影響はありません。  
THERE IS NO INFLUENCE IN THE PRODUCT PERFORMANCE THOUGH THE BLACK SPOT ETC. MIGHT BE CONFIRMED TO THE PLASTIC PART OF THIS PRODUCT AND THE SHADE MIGHT BE DIFFERENT.
- 5. アプリケーション仕様書 (コネクタ取扱説明書): AS-502380-001  
APPLICATION SPECIFICATIONS (CONNECTOR MANUAL): AS-502380-001
- 6. 製品仕様書: PS-502382-001  
Product specification: PS-502382-001

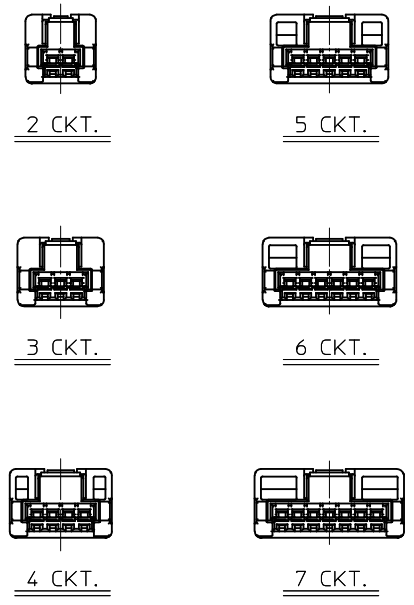

極数の種類 (正面図)  
KIND OF CKT. NO. (FRONT VIEW)

10	11.85	502380-070*	7
8.75	10.6	502380-060*	6
7.5	9.35	502380-050*	5
6.25	8.1	502380-040*	4
5	6.85	502380-030*	3
3.75	5.6	502380-020*	2
B	A	ポリ袋 POLYBAG PACKAGE オーダー番号 ORDER No.	極数 CKT. No.

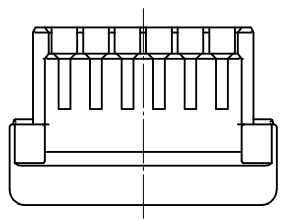

REVISED EC NO: J2013-0870 DRWN: KWASHIO 2013/02/07 CHKD: KASAKAWA 2013/02/13 APPR: Y0 ITO 2013/02/13	GENERAL TOLERANCES (UNLESS SPECIFIED)		DIMENSION STYLE MM ONLY	SCALE 5:1	DESIGN UNITS METRIC	THIRD ANGLE PROJECTION
	10 UNDER	±0.2	DRAWN BY T. MIYAZAKI	DATE 2006/08/28	TITLE 1.25 W/B CONN. SINGLE PLUG HOUSING 2-7CKT.	
	10 OVER 30 UNDER	±0.25	CHECKED BY K. ASAKAWA	DATE 2006/08/28	MATERIAL NO. SD-502380-001	
	30 OVER	±0.3	APPROVED BY Y0. ITO	DATE 2006/08/28	SHEET NO. 1 OF 2	
REV	DESCRIPTION	ANGULAR ±3 ° DRAFT WHERE APPLICABLE MUST REMAIN WITHIN DIMENSIONS	SIZE A3	THIS DRAWING CONTAINS INFORMATION THAT IS PROPRIETARY TO MOLEX INCORPORATED AND SHOULD NOT BE USED WITHOUT WRITTEN PERMISSION		

部品 PART	材質 MATERIAL
ハウジング HOUSING	ポリブチレンテレフタレート UL94V-0 色: SHEET 2 参照 POLYBUTYLENE TEREPHTHALATE UL94V-0 COLOR: SEE SHEET 2

9 8 7 6 5 4 3 2

10 9 8 7 6 5 4 3 2 1

HSG COLOR : GREEN	HSG COLOR : BLUE	HSG COLOR : RED	HSG COLOR : BLACK	HSG COLOR : NATURAL	
502380-0706	502380-0704	502380-0702	502380-0701	502380-0700	7
502380-0606	502380-0604	502380-0602	502380-0601	502380-0600	6
502380-0506	502380-0504	502380-0502	502380-0501	502380-0500	5
502380-0406	502380-0404	502380-0402	502380-0401	502380-0400	4
502380-0306	502380-0304	502380-0302	502380-0301	502380-0300	3
502380-0206	502380-0204	502380-0202	502380-0201	502380-0200	2
ホリ袋 POLYBAG PACKAGE オーダー番号 ORDER No.					極数 (KT. NO.)

REVISED EC NO.: J2013-0870 DRWN: KWASHIO 2013/02/07 CHKD: KASAKAWA 2013/02/13 APPR: Y. ITO 2013/02/13	GENERAL TOLERANCES (UNLESS SPECIFIED)		DIMENSION STYLE <b>MM ONLY</b>	SCALE ---	DESIGN UNITS <b>METRIC</b>	THIRD ANGLE PROJECTION
	10 UNDER	±0.2	DRAWN BY T. MIYAZAKI	DATE 2006/08/28	TITLE <b>1.25 W/B CONN. SINGLE PLUG HOUSING 2-7CKT.</b>	
	10 OVER 30 UNDER	±0.25	CHECKED BY K. ASAKAWA	DATE 2006/08/28		
	30 OVER	±0.3	APPROVED BY Y. ITO	DATE 2006/08/28		
ANGULAR ±3 °		MATERIAL NO. <b>SEE TABLE</b>		DOCUMENT NO. <b>SD-502380-001</b>	SHEET NO. <b>2 OF 2</b>	
DRAFT WHERE APPLICABLE MUST REMAIN WITHIN DIMENSIONS		THIS DRAWING CONTAINS INFORMATION THAT IS PROPRIETARY TO MOLEX INCORPORATED AND SHOULD NOT BE USED WITHOUT WRITTEN PERMISSION				

9 8 7 6 5 4 3 2

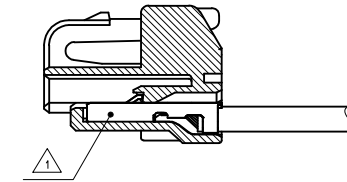
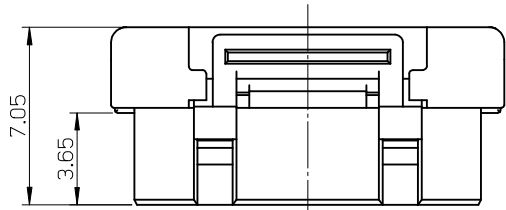

ターミナル装着図  
TERMINAL ASSEMBLY DRAWING

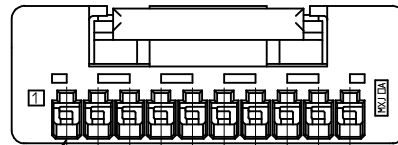
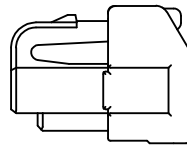
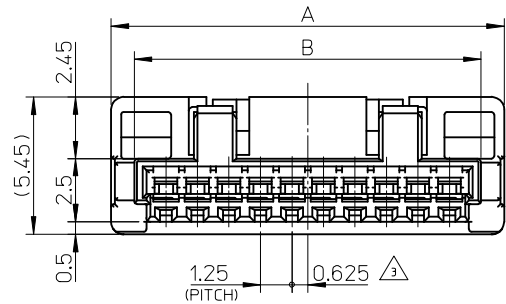

回路番号 1  
CKT NO. 1

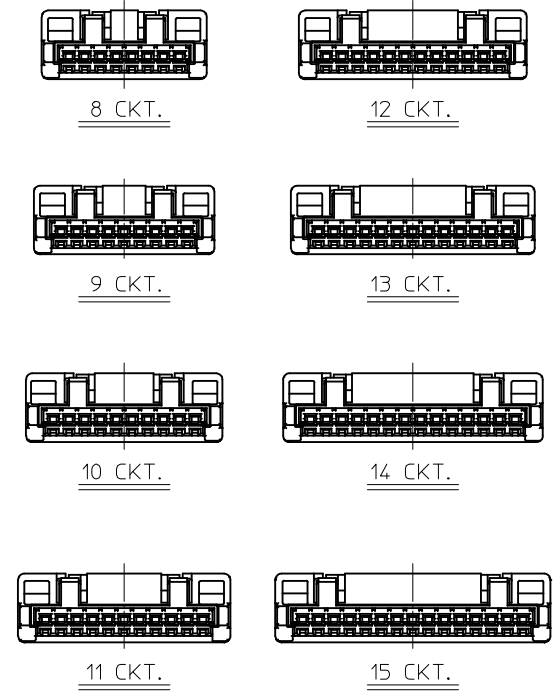
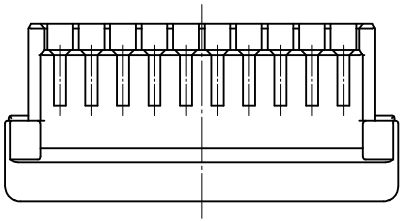

極数の種類 (正面図)  
KIND OF CKT. NO. (FRONT VIEW)

NOTES

- 適合ターミナル: 502381-00\*\*  
APPLICABLE TARMINAL : 502381-00\*\*
- 嵌合相手: 502382-\*\*09 / 502386-\*\*09  
MATE WITH : 502382-\*\*09 / 502386-\*\*09
- 極数/2=偶数に適用。  
APPLY FOR CKT. SIZE / 2 = EVEN.
- 本製品のプラスチック部に黒点等が確認される場合や色合いが異なる場合がありますが、製品性能に影響はありません。  
THERE IS NO INFLUENCE IN THE PRODUCT PERFORMANCE THOUGH THE BLACK SPOT ETC. MIGHT BE CONFIRMED TO THE PLASTIC PART OF THIS PRODUCT AND THE SHADE MIGHT BE DIFFERENT.
- アプリケーション仕様書 (コネクタ取扱説明書) : AS-502380-001  
APPLICATION SPECIFICATIONS (CONNECTOR MANUAL) : AS-502380-001.
- 製品仕様書 : PS-502382-001  
Product specification: PS-502382-001
- ELV AND RoHS COMPLIANT.

20	21.85	502380-150*	15
18.75	20.6	502380-140*	14
17.5	19.35	502380-130*	13
16.25	18.1	502380-120*	12
15	16.85	502380-110*	11
13.75	15.6	502380-100*	10
12.5	14.35	502380-090*	9
11.25	13.1	502380-080*	8
B	A	ポリ袋 POLYBAG PACKAGE オーダー番号 ORDER NO.	極数 CKT. NO.

REVISED EC NO: J2013-0870 DRWN:KASHIO 2013/02/17 CHKD:KASAKAWA 2013/02/13 APPR:Y0 ITO 2013/02/13	GENERAL TOLERANCES (UNLESS SPECIFIED)		DIMENSION STYLE MM ONLY	SCALE 5:1	DESIGN UNITS METRIC	THIRD ANGLE PROJECTION
	10 UNDER	±0.2	DRAWN BY T. MIYAZAKI	DATE 2006/08/28	TITLE 1.25 W/B CONN. SINGLE PLUG HOUSING 8-15CKT.	
	10 OVER 30 UNDER	±0.25	CHECKED BY K. ASAKAWA	DATE 2006/08/28		
	30 OVER	±0.3	APPROVED BY Y0. ITO	DATE 2006/08/28		
ANGULAR ±3 °	DRAFT WHERE APPLICABLE MUST REMAIN WITHIN DIMENSIONS		MATERIAL NO. SEE TABLE	DOCUMENT NO. SD-502380-002	SHEET NO. 1 OF 2	
SIZE A3	THIS DRAWING CONTAINS INFORMATION THAT IS PROPRIETARY TO MOLEX INCORPORATED AND SHOULD NOT BE USED WITHOUT WRITTEN PERMISSION					

部品 PART	材質 MATERIAL
ハウジング HOUSING	ポリブチレンテレフタレート UL94V-0 色: SHEET 2 参照 POLYBUTYLENE TEREPHTHALATE UL94V-0 COLOR : SEE SHEET 2

10 9 8 7 6 5 4 3 2 1

HSG COLOR : ORANGE	
	15
	14
	13
	12
	11
	10
502380-0908	9
	8
ポリ袋 POLYBAG PACKAGE オーダー番号 ORDER No.	極数 (KT. NO.)

HSG COLOR : GREEN	HSG COLOR : BLUE	HSG COLOR : YELLOW	HSG COLOR : RED	HSG COLOR : BLACK	HSG COLOR : NATURAL	
502380-1506	502380-1504		502380-1502	502380-1501	502380-1500	15
502380-1406	502380-1404		502380-1402	502380-1401	502380-1400	14
502380-1306	502380-1304		502380-1302	502380-1301	502380-1300	13
502380-1206	502380-1204		502380-1202	502380-1201	502380-1200	12
502380-1106	502380-1104		502380-1102	502380-1101	502380-1100	11
502380-1006	502380-1004		502380-1002	502380-1001	502380-1000	10
502380-0906	502380-0904	502380-0903	502380-0902	502380-0901	502380-0900	9
502380-0806	502380-0804		502380-0802	502380-0801	502380-0800	8
ポリ袋 POLYBAG PACKAGE オーダー番号 ORDER No.						極数 (KT. NO.)

REVISED EC NO: J2013-0870 DRWN: KWASHIO 2013/02/07 CHKD: KASAKAWA 2013/02/13 APPR: Y. ITO 2013/02/13	GENERAL TOLERANCES (UNLESS SPECIFIED)		DIMENSION STYLE <b>MM ONLY</b>	SCALE ----	DESIGN UNITS <b>METRIC</b>	THIRD ANGLE PROJECTION
	10 UNDER	±0.2	DRAWN BY T. MIYAZAKI	DATE 2006/08/28	TITLE 1.25 W/B CONN. SINGLE PLUG HOUSING 8-15CKT.	
	10 OVER 30 UNDER	±0.25	CHECKED BY K. ASAKAWA	DATE 2006/08/28	<b>molex</b> DOCUMENT NO. SD-502380-002 SHEET NO. 2 OF 2	
	30 OVER	±0.3	APPROVED BY Y. ITO	DATE 2006/08/28		
ANGULAR ±3 °		MATERIAL NO. <b>SEE TABLE</b>		THIS DRAWING CONTAINS INFORMATION THAT IS PROPRIETARY TO MOLEX INCORPORATED AND SHOULD NOT BE USED WITHOUT WRITTEN PERMISSION		
DRAFT WHERE APPLICABLE MUST REMAIN WITHIN DIMENSIONS						

9 8 7 6 5 4 3 2