

RECOMMENDED PCB LAYOUT

- NOTES:
- MATERIAL:
 - HSG: LCP, GLASS-FILLED, UL94V-0, COLOR: BLACK
 - PIN: 0.64MM SQ PIN, COPPER ALLOY
 - PLATING TYPE:
 - (1) : GOLD FLASH OVER
1.25µm MIN. NICKEL OVERALL
 - (2) : 0.05µm MIN. GOLD PLATE ON CONTACT AND 2.50µm MIN. TIN ON SOLDER TAIL OVER
1.25µm MIN. NICKEL OVERALL
 - (3) : 0.38µm MIN. GOLD PLATE ON CONTACT AND 2.00µm MIN. TIN ON SOLDER TAIL OVER
1.25µm MIN. NICKEL OVERALL.
 - (4) : 0.75µm MIN. GOLD PLATE ON CONTACT AND 2.00µm MIN. TIN ON SOLDER TAIL OVER
1.25µm MIN. NICKEL OVERALL.
 - (5) : 2.50µm MIN. TIN IN SELECTED AREA OVER
1.25µm MIN. NICKEL OVERALL.
 - THE ABOVE 10 CKT IS FOR ILLUSTRATION PURPOSE ONLY.
 - PACKAGING OPTION: SEE TABLE
 - PACKAGING SPECIFICATION:
 - TRAY: PK-89990-489
 - BULK: PK-89990-491
 - PRODUCT SPECIFICATION: PS-87920-019
 - WAFER TO BE FLAT WITHIN 0.003mm/mm
 - IRREGULAR CIRCUIT CUTOFF WITHIN BREAKAWAY SECTION IS PERMISSIBLE. CUTTING OR CHIPPING OF THE MAIN BODY IS NOT ACCEPTABLE.
 - RECOMMENDED PCB THICKNESS 1.60MM
 - PARTS ARE NOT STACKABLE ON 2.54 CENTER

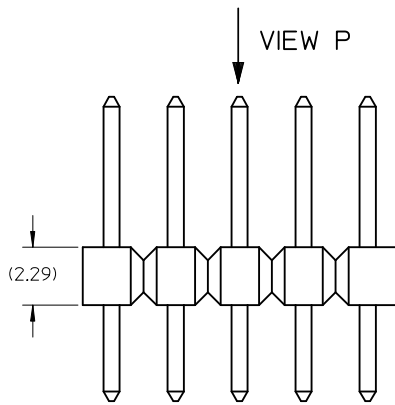

VIEW P

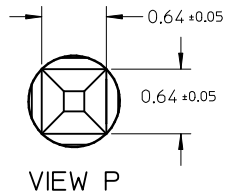

VIEW P

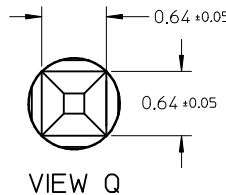
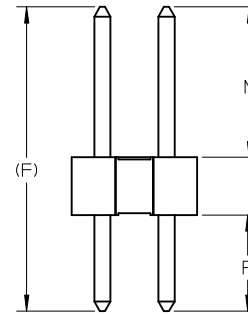

VIEW Q

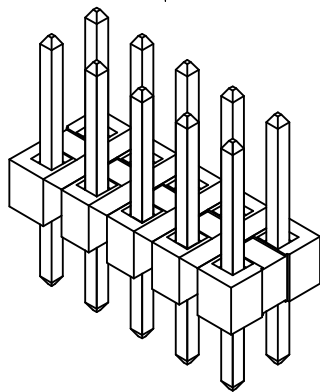

VIEW Q

VOID PART NUMBER EC NO: S2017-0345 DRWN:CGOH CHKD:FCSS00 APPR:KILIM 2016/12/07 2016/12/20 2016/12/21	DESCRIPTION REV	QUALITY SYMBOLS ▽=0 ◻=0	GENERAL TOLERANCES (UNLESS SPECIFIED)		DIMENSION STYLE MM ONLY		SCALE NTS	DESIGN UNITS METRIC	THIRD ANGLE PROJECTION		
			mm	INCH	DRAWN BY	DATE	TITLE				
		4 PLACES	± ---	± ---	SKLIM01	2006/03/11	CUSTOM HEADER 2.54MM PITCH DUAL ROW SINGLE WAFER HEADER, T/H MOLEX INCORPORATED				
		3 PLACES	± ---	± ---	CHECKED BY	DATE					
2 PLACES	± 0.2	± ---	PATEY	2006/03/20	MOLEX INCORPORATED DOCUMENT NO. SD-87914-045						
1 PLACE	± ---	± ---	APPROVED BY	DATE							
ANGULAR ± 3 °			DRAFT WHERE APPLICABLE MUST REMAIN WITHIN DIMENSIONS		MATERIAL NO. SEE TABLE		SHEET NO. 1 OF 3		THIS DRAWING CONTAINS INFORMATION THAT IS PROPRIETARY TO MOLEX INCORPORATED AND SHOULD NOT BE USED WITHOUT WRITTEN PERMISSION		

PART WITH KINKDED TAIL AND VOIDED PIN (FOR REFERENCE USED ONLY)

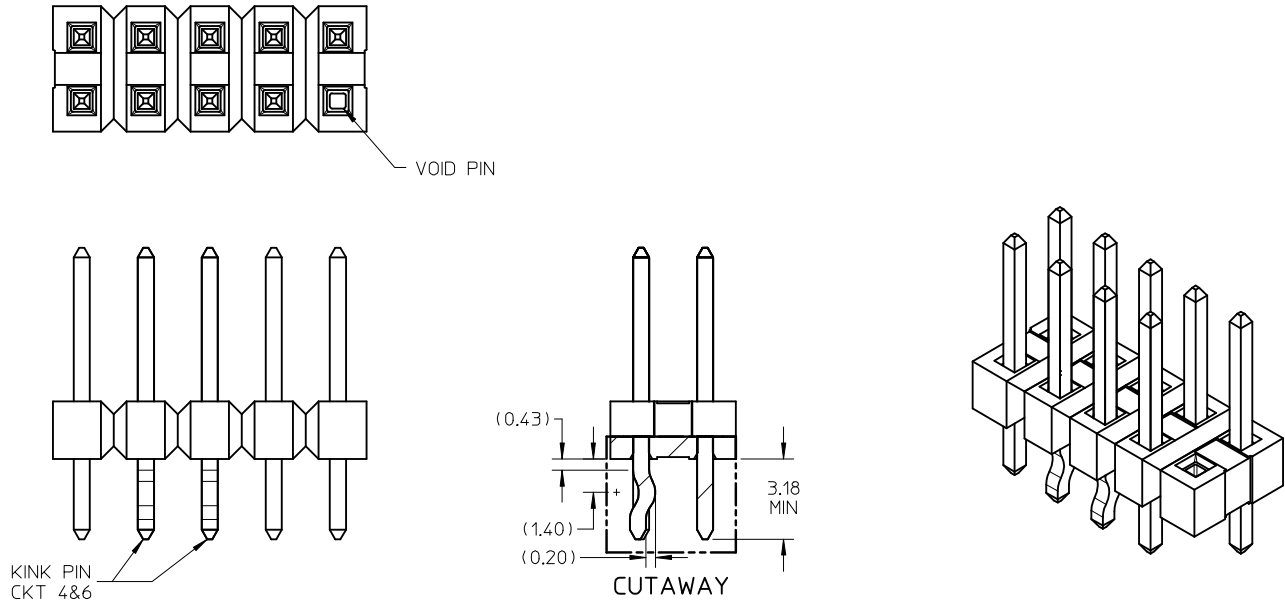

VOID PART NUMBER EC NO: S2017-0345 DRWN:CGOH 2016/12/07 CHKD:FC500 2016/12/20 APPR:KLLIM 2016/12/21	DESCRIPTION REV	QUALITY SYMBOLS ▽=0 ◻=0	GENERAL TOLERANCES (UNLESS SPECIFIED)		DIMENSION STYLE MM ONLY		SCALE NTS	DESIGN UNITS METRIC	THIRD ANGLE PROJECTION		
			mm	INCH	DRAWN BY	DATE	TITLE				
		4 PLACES	± ---	± ---	SKLIM01	2006/03/11	CUSTOM HEADER 2.54MM PITCH DUAL ROW SINGLE WAFER HEADER, T/H MOLEX INCORPORATED				
		3 PLACES	± ---	± ---	CHECKED BY	DATE					
2 PLACES	± 0.2	± ---	PATEY	2006/03/20	MATERIAL NO. DOCUMENT NO. SHEET NO. SEE TABLE SD-87914-045 2 OF 3						
1 PLACE	± ---	± ---	APPROVED BY	DATE							
ANGULAR ± 3 °			DRAFT WHERE APPLICABLE MUST REMAIN WITHIN DIMENSIONS		PATEY 2006/03/20		THIS DRAWING CONTAINS INFORMATION THAT IS PROPRIETARY TO MOLEX INCORPORATED AND SHOULD NOT BE USED WITHOUT WRITTEN PERMISSION				

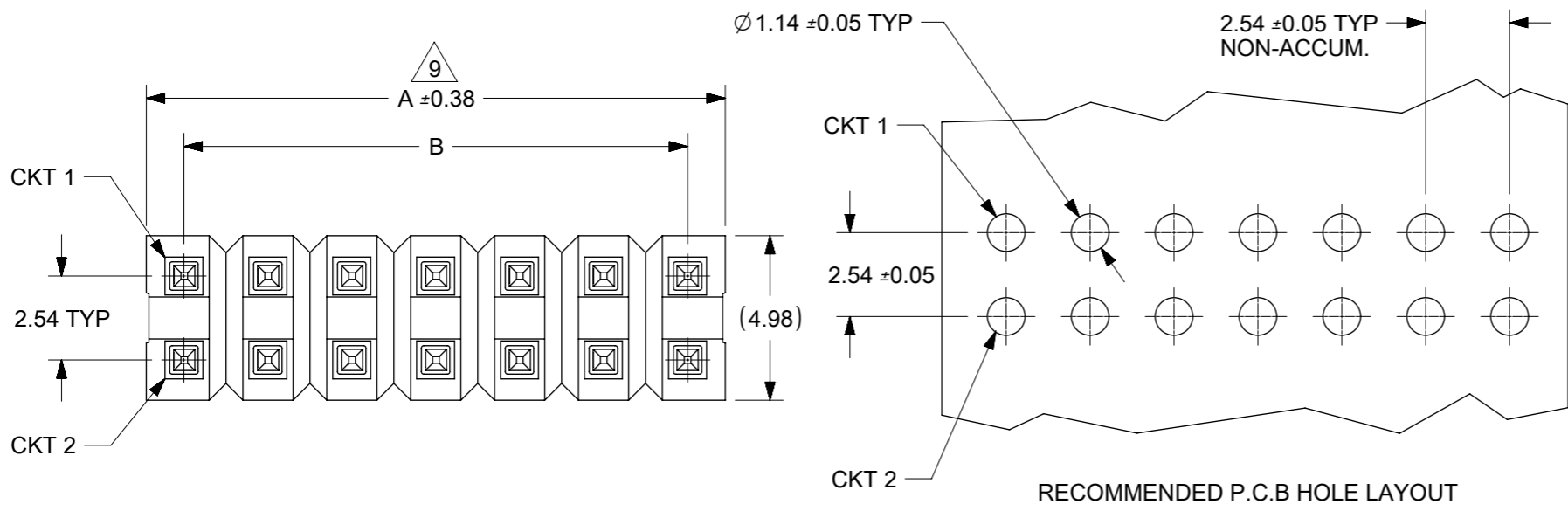

RECOMMENDED P.C.B HOLE LAYOUT

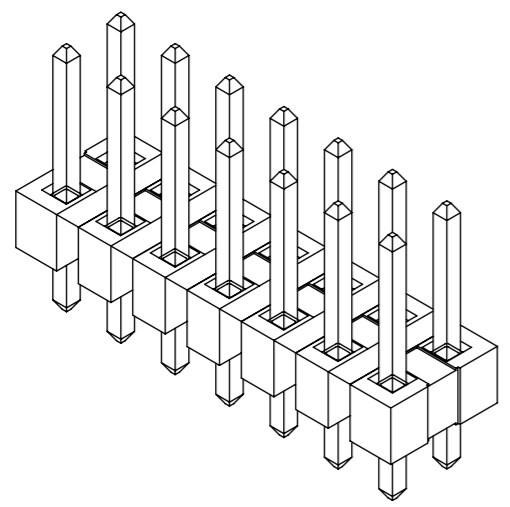
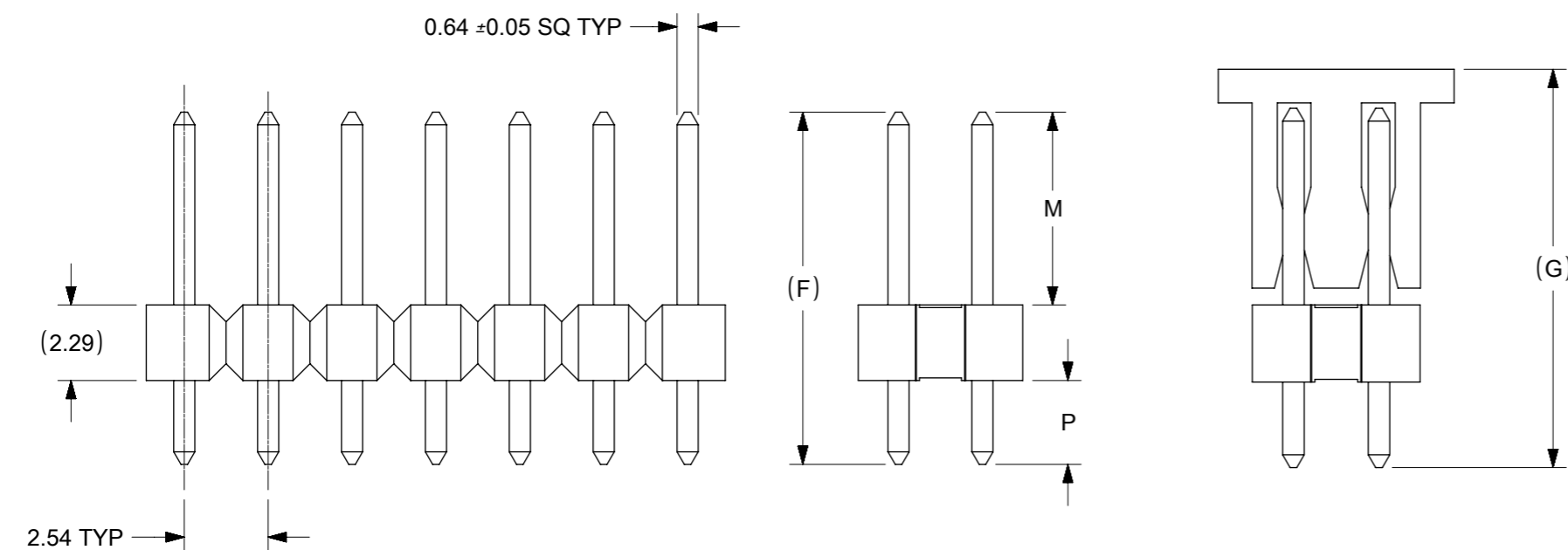

- NOTES:
- MATERIAL:
HSG: LCP, GLASS-FILLED, UL94V-0,
COLOR: BLACK
PIN: 0.64MM SQ PIN, COPPER ALLOY
 - PLATING TYPE:
(1) : 0.0254 μ m GOLD FLASH OVER
1.25 μ m MIN. NICKEL OVERALL.
(2) : 0.025 μ m MIN. GOLD PLATE ON CONTACT AND
1.88 μ m MIN. TIN ON SOLDER TAIL OVER
1.25 μ m MIN. NICKEL OVERALL.
(3) : 0.25 μ m MIN. GOLD PLATE ON CONTACT AND
1.88 μ m MIN. TIN ON SOLDER TAIL OVER
1.25 μ m MIN. NICKEL OVERALL.
(4) : 0.38 μ m MIN. GOLD PLATE ON CONTACT AND
1.88 μ m MIN. TIN ON SOLDER TAIL OVER
1.25 μ m MIN. NICKEL OVERALL.
(5) : 0.75 μ m MIN. GOLD PLATE ON CONTACT AND
1.88 μ m MIN. TIN ON SOLDER TAIL OVER
1.25 μ m MIN. NICKEL OVERALL
(6) : 2.50 μ m MIN. TIN OVER 1.25 m MIN. NICKEL OVERALL.
(7) : 0.38 μ m MIN. GOLD PLATE ON CONTACT AND
2.50 μ m MIN. TIN ON SOLDER TAIL OVER
1.25 μ m MIN. NICKEL OVERALL.
(8) : 0.38 μ m MIN. GOLD PLATE ON CONTACT AND
0.05 μ m MIN. GOLD FLASH ON SOLDER TAIL OVER
1.25 μ m MIN. NICKEL OVERALL.
(9) : 0.05 - 0.25 μ m MIN. GOLD FLASH OVER
1.25 μ m MIN. NICKEL OVERALL.
 - PIN PUSHOUT FORCE: 1KG MIN IN EITHER DIRECTION
 - THE ABOVE 14 CKT IS FOR ILLUSTRATION PURPOSE ONLY.
 - FOR PACKAGING OPTION PLEASE REFER TO THE TABLE.
 - RECOMMENDED PCB THICKNESS 1.60MM.
 - PRODUCT SPECIFICATION: PS-87920-019
 - WAFER TO BE FLAT WITHIN 0.003mm/mm
 - IRREGULAR CIRCUIT CUTOFF WITHIN BREAKAWAY SECTION IS PERMISSIBLE. CUTTING OR CHIPPING OF THE MAIN BODY IS NOT ACCEPTABLE.
 - PARTS ARE NOT STACKABLE ON 2.54 CENTER
 - CAP TO BE PLACED AS CENTRAL OF PART AS POSSIBLE WITH THE TOP SURFACE FLAT FOR PICK AND PLACE.
 - PACKAGING SPECIFICATION:
TRAY: PK-89990-489
BULK: PK-89990-491
TUBE: PK-87914-300

REVISION OF DRAWING MAY BE CHANGED DURING FINAL RELEASED FOR PRODUCTION.

RELEASE STATUS	RELEASE DATE
----------------	--------------

THIS DRAWING CONTAINS INFORMATION THAT IS PROPRIETARY TO MOLEX ELECTRONIC TECHNOLOGIES, LLC AND SHOULD NOT BE USED WITHOUT WRITTEN PERMISSION									
MIGRATED TO NX EC NO: 114466 DRWN: PKH CHK'D: REV APPR: ISHWARG	GENERAL TOLERANCES (UNLESS SPECIFIED)		DIMENSION UNITS		SCALE				
			MM	INCH	MM	NTS			
	4 PLACES	±	±	DRWN BY	DATE		2.54MM PITCH DUAL ROW HEADER SINGLE WAFER, T/H		
	3 PLACES	±	±	KCHO	2004/11/05				
	2 PLACES	± 0.2	±	CHK'D BY	DATE		PRODUCT CUSTOMER DRAWING		
1 PLACES	±	±	PTLIM	2004/12/08					
0 PLACES	±	±	APPR BY	DATE		SERIES: 87914 MATERIAL NUMBER: SEE TABLE CUSTOMER: GENERAL MARKET			
			MLONG	2010/09/06					
	ANGULAR TOL = 3.0		DRAWING SIZE	THIRD ANGLE PROJECTION		DOCUMENT NUMBER: SD-87914-013 DOC TYPE: PSD DOC PART: 000 SHEET NUMBER: 1 OF 45			
D17			A3						

PART NO FOR TRAY PACKAGING	PART NO. FOR TUBE WITHOUT CAP PACKAGING	PART NO. FOR TUBE WITH CAP PACKAGING	PART NO. FOR TAPE & REEL WITHOUT CAP PACKAGING	PART NO. FOR TAPE & REEL WITH CAP PACKAGING	CKT SIZE	VOID POSITION	PLATING TYPE	DIMENSION					
								A	B	F	M	P	G
87914-0811	-----	-----	-----	-----	8	-----	1	10.16	7.62	10.92	5.84	2.79	----
87914-0821	-----	-----	-----	-----	8	-----	1	10.16	7.62	12.25	7.00	2.96	----
87914-0831	-----	-----	-----	-----	8	-----	1	10.16	7.62	13.38	6.09	5.00	----
87914-0812	-----	-----	-----	-----	8	-----	2	10.16	7.62	10.92	5.84	2.79	----
87914-0822	-----	-----	-----	-----	8	-----	2	10.16	7.62	12.25	7.00	2.96	----
87914-0832	-----	-----	-----	-----	8	-----	2	10.16	7.62	13.38	6.09	5.00	----
87914-0813	-----	-----	-----	-----	8	-----	3	10.16	7.62	10.92	5.84	2.79	----
87914-0823	-----	-----	-----	-----	8	-----	3	10.16	7.62	12.25	7.00	2.96	----
87914-0833	-----	-----	-----	-----	8	-----	4	10.16	7.62	13.38	6.09	5.00	----
87914-0814	-----	-----	-----	-----	8	-----	4	10.16	7.62	10.92	5.84	2.79	----
87914-0824	-----	-----	-----	-----	8	-----	4	10.16	7.62	12.25	7.00	2.96	----
87914-0834	-----	-----	-----	-----	8	-----	4	10.16	7.62	13.38	6.09	5.00	----
87914-0815	-----	-----	-----	-----	8	-----	5	10.16	7.62	10.92	5.84	2.79	----
87914-0825	-----	-----	-----	-----	8	-----	5	10.16	7.62	12.25	7.00	2.96	----
87914-0835	-----	-----	-----	-----	8	-----	5	10.16	7.62	13.38	6.09	5.00	----
87914-0816	-----	-----	-----	-----	8	-----	6	10.16	7.62	10.92	5.84	2.79	----
87914-0826	-----	-----	-----	-----	8	-----	6	10.16	7.62	12.25	7.00	2.96	----
87914-0836	-----	-----	-----	-----	8	-----	6	10.16	7.62	13.38	6.09	5.00	----
87914-0807	-----	-----	-----	-----	8	2,3,4,5,6,8	6	10.16	7.62	21.75	16.51	2.95	----

THIS DRAWING CONTAINS INFORMATION THAT IS PROPRIETARY TO MOLEX ELECTRONIC TECHNOLOGIES, LLC AND SHOULD NOT BE USED WITHOUT WRITTEN PERMISSION

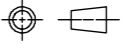
MIGRATED TO NX 2017/01/18 EC NO: 114466 DRWN: PKH CHK'D: 2017/03/15 APPR: ISHWARG	GENERAL TOLERANCES (UNLESS SPECIFIED)		DIMENSION UNITS		SCALE			
			MM	INCH	MM	NTS		
	4 PLACES	±	±	DRWN BY	DATE			2.54MM PITCH DUAL ROW HEADER SINGLE WAFER, T/H
	3 PLACES	±	±	KCHO	2004/11/05			
	2 PLACES	± 0.2	±	CHK'D BY	DATE			
	1 PLACES	±	±	PTLIM	2004/12/08			
	0 PLACES	±	±	APPR BY	DATE			
	ANGULAR TOL = 3.0			MLONG	2010/09/06			PRODUCT CUSTOMER DRAWING
	DRAFT WHERE APPLICABLE MUST REMAIN WITHIN DIMENSIONS			DRAWING SIZE	THIRD ANGLE PROJECTION			SERIES
				A3				MATERIAL NUMBER
						87914		
						SEE TABLE		
						CUSTOMER		
						GENERAL MARKET		
						DOCUMENT NUMBER		
						SD-87914-013		
						DOC TYPE		
						PSD		
						DOC PART		
						000		
						SHEET NUMBER		
						6 OF 45		

RELEASE STATUS	RELEASE DATE
----------------	--------------

PART NO FOR TRAY PACKAGING	PART NO. FOR TUBE WITHOUT CAP PACKAGING	PART NO. FOR TUBE WITH CAP PACKAGING	PART NO. FOR TAPE & REEL WITHOUT CAP PACKAGING	PART NO. FOR TAPE & REEL WITH CAP PACKAGING	PART NO. FOR BULK PACKAGING	CKT SIZE	VOID POSITION	PLATING TYPE	DIMENSION					
									A	B	F	M	P	G
87914-1011	-----	-----	-----	-----	-----	10	-----	1	12.70	10.16	10.92	5.84	2.79	----
87914-1021	-----	-----	-----	-----	-----	10	-----	1	12.70	10.16	12.25	7.00	2.96	----
87914-1031	-----	-----	-----	-----	-----	10	-----	1	12.70	10.16	13.38	6.09	5.00	----
87914-1012	-----	-----	-----	-----	-----	10	-----	2	12.70	10.16	10.92	5.84	2.79	----
87914-1022	-----	-----	-----	-----	-----	10	-----	2	12.70	10.16	12.25	7.00	2.96	----
87914-1032	-----	-----	-----	-----	-----	10	-----	2	12.70	10.16	13.38	6.09	5.00	----
87914-1013	-----	-----	-----	-----	-----	10	-----	3	12.70	10.16	10.92	5.84	2.79	----
87914-1023	-----	-----	-----	-----	-----	10	-----	3	12.70	10.16	12.25	7.00	2.96	----
87914-1033	-----	-----	-----	-----	-----	10	-----	3	12.70	10.16	13.38	6.09	5.00	----
87914-1014	-----	-----	-----	-----	-----	10	-----	4	12.70	10.16	10.92	5.84	2.79	----
87914-1024	-----	-----	-----	-----	-----	10	-----	4	12.70	10.16	12.25	7.00	2.96	----
87914-1034	-----	-----	-----	-----	-----	10	-----	4	12.70	10.16	13.38	6.09	5.00	----
87914-1015	-----	-----	-----	-----	-----	10	-----	5	12.70	10.16	10.92	5.84	2.79	----
87914-1025	-----	-----	-----	-----	-----	10	-----	5	12.70	10.16	12.25	7.00	2.96	----
87914-1035	-----	-----	-----	-----	-----	10	-----	5	12.70	10.16	13.38	6.09	5.00	----
87914-1016	-----	-----	-----	-----	-----	10	-----	6	12.70	10.16	10.92	5.84	2.79	----
87914-1026	-----	-----	-----	-----	-----	10	-----	6	12.70	10.16	12.25	7.00	2.96	----
87914-1036	-----	-----	-----	-----	-----	10	-----	6	12.70	10.16	13.38	6.09	5.00	----
87914-0001	-----	-----	-----	-----	-----	10	-----	7	12.70	10.16	12.07	5.97	3.81	----
-----	-----	-----	-----	-----	87914-1037	10	9	4	12.70	10.16	10.92	5.84	2.79	----

THIS DRAWING CONTAINS INFORMATION THAT IS PROPRIETARY TO MOLEX ELECTRONIC TECHNOLOGIES, LLC AND SHOULD NOT BE USED WITHOUT WRITTEN PERMISSION

MIGRATED TO NX EC NO: 114466 DRWN: PKH CHK'D: REV APPR: ISHWARG	2017/01/18		2017/03/15		GENERAL TOLERANCES (UNLESS SPECIFIED)		DIMENSION UNITS		SCALE								
					MM INCH		MM NTS		NTS								
	4 PLACES ±		±		KCHO		DRWN BY		DATE		2.54MM PITCH DUAL ROW HEADER SINGLE WAFER, T/H						
	3 PLACES ±		±		PTLIM		CHK'D BY		DATE								
	2 PLACES ± 0.2		±		MLONG		APPR BY		DATE		PRODUCT CUSTOMER DRAWING						
	1 PLACES ±		±		DRAWING SIZE		THIRD ANGLE PROJECTION		THIRD ANGLE PROJECTION								
0 PLACES ±		±		A3		ANGULAR TOL = 3.0		DRAFT WHERE APPLICABLE MUST REMAIN WITHIN DIMENSIONS		SERIES		MATERIAL NUMBER		CUSTOMER			
D17				A3		DRAFT WHERE APPLICABLE MUST REMAIN WITHIN DIMENSIONS		DRAFT WHERE APPLICABLE MUST REMAIN WITHIN DIMENSIONS		87914		SEE TABLE		GENERAL MARKET			
										DOCUMENT NUMBER		DOC TYPE		DOC PART		SHEET NUMBER	
										SD-87914-013		PSD		000		8 OF 45	

RELEASE STATUS	RELEASE DATE
----------------	--------------

PART NO FOR TRAY PACKAGING	PART NO. FOR TUBE WITHOUT CAP PACKAGING	PART NO. FOR TUBE WITH CAP PACKAGING	PART NO. FOR TAPE & REEL WITHOUT CAP PACKAGING	PART NO. FOR TAPE & REEL WITH CAP PACKAGING	CKT SIZE	VOID POSITION	PLATING TYPE	DIMENSION				
								A	B	F	M	P
87914-1211	-----	-----	-----	-----	12	-----	1	15.24	12.70	10.92	5.84	2.79
-----	87914-1291	-----	-----	-----	12	-----	9	15.24	12.70	10.92	5.84	2.79
87914-1221	-----	-----	-----	-----	12	-----	1	15.24	12.70	12.25	7.00	2.96
87914-1231	-----	-----	-----	-----	12	-----	1	15.24	12.70	13.38	6.09	5.00
87914-1212	-----	-----	-----	-----	12	-----	2	15.24	12.70	10.92	5.84	2.79
87914-1222	-----	-----	-----	-----	12	-----	2	15.24	12.70	12.25	7.00	2.96
87914-1232	-----	-----	-----	-----	12	-----	2	15.24	12.70	13.38	6.09	5.00
87914-1213	-----	-----	-----	-----	12	-----	3	15.24	12.70	10.92	5.84	2.79
87914-1223	-----	-----	-----	-----	12	-----	3	15.24	12.70	12.25	7.00	2.96
87914-1233	-----	-----	-----	-----	12	-----	3	15.24	12.70	13.38	6.09	5.00
87914-1214	-----	-----	-----	-----	12	-----	4	15.24	12.70	10.92	5.84	2.79
87914-1224	-----	-----	-----	-----	12	-----	4	15.24	12.70	12.25	7.00	2.96
87914-1234	-----	-----	-----	-----	12	-----	4	15.24	12.70	13.38	6.09	5.00
87914-1215	-----	-----	-----	-----	12	-----	5	15.24	12.70	10.92	5.84	2.79
87914-1225	-----	-----	-----	-----	12	-----	5	15.24	12.70	12.25	7.00	2.96
87914-1235	-----	-----	-----	-----	12	-----	5	15.24	12.70	13.38	6.09	5.00
87914-1216	-----	-----	-----	-----	12	-----	6	15.24	12.70	10.92	5.84	2.79
87914-1226	-----	-----	-----	-----	12	-----	6	15.24	12.70	12.25	7.00	2.96
87914-1236	-----	-----	-----	-----	12	-----	6	15.24	12.70	13.38	6.09	5.00

THIS DRAWING CONTAINS INFORMATION THAT IS PROPRIETARY TO MOLEX ELECTRONIC TECHNOLOGIES, LLC AND SHOULD NOT BE USED WITHOUT WRITTEN PERMISSION

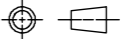
MIGRATED TO NX EC NO: 114466 DRWN: PKH CHK'D: ISHWARG REV APPR: ISHWARG	2017/01/18		2017/03/15		GENERAL TOLERANCES (UNLESS SPECIFIED)		DIMENSION UNITS		SCALE								
					MM INCH		MM NTS		NTS								
	4 PLACES		±		±		KCHO		DATE		2.54MM PITCH DUAL ROW HEADER SINGLE WAFER, T/H						
	3 PLACES		±		±		CHK'D BY		DATE								
	2 PLACES		± 0.2		±		PTLIM		2004/12/08								
	1 PLACES		±		±		APPR BY		DATE		PRODUCT CUSTOMER DRAWING						
	0 PLACES		±		±		MLONG		2010/09/06								
	ANGULAR TOL = 3.0						DRAWING SIZE		THIRD ANGLE PROJECTION		SERIES: 87914 MATERIAL NUMBER: SEE TABLE CUSTOMER: GENERAL MARKET						
	DRAFT WHERE APPLICABLE MUST REMAIN WITHIN DIMENSIONS						A3										
	RELEASE STATUS		RELEASE DATE								DOCUMENT NUMBER		DOC TYPE		DOC PART		SHEET NUMBER
D17										SD-87914-013		PSD		000		9 OF 45	

PART NO FOR TRAY PACKAGING	PART NO. FOR TUBE WITHOUT CAP PACKAGING	PART NO. FOR TUBE WITH CAP PACKAGING	PART NO. FOR TAPE & REEL WITHOUT CAP PACKAGING	PART NO. FOR TAPE & REEL WITH CAP PACKAGING	CKT SIZE	VOID POSITION	PLATING TYPE	DIMENSION				
								A	B	F	M	P
87914-1411	-----	-----	-----	-----	14	-----	1	17.78	15.24	10.92	5.84	2.79
87914-1421	-----	-----	-----	-----	14	-----	1	17.78	15.24	12.25	7.00	2.96
87914-1431	-----	-----	-----	-----	14	-----	1	17.78	15.24	13.38	6.09	5.00
87914-1412	-----	-----	-----	-----	14	-----	2	17.78	15.24	10.92	5.84	2.79
87914-1422	-----	-----	-----	-----	14	-----	2	17.78	15.24	12.25	7.00	2.96
87914-1432	-----	-----	-----	-----	14	-----	2	17.78	15.24	13.38	6.09	5.00
87914-1413	-----	-----	-----	-----	14	-----	3	17.78	15.24	10.92	5.84	2.79
87914-1423	-----	-----	-----	-----	14	-----	3	17.78	15.24	12.25	7.00	2.96
87914-1433	-----	-----	-----	-----	14	-----	3	17.78	15.24	13.38	6.09	5.00
87914-1414	-----	-----	-----	-----	14	-----	4	17.78	15.24	10.92	5.84	2.79
87914-1424	-----	-----	-----	-----	14	-----	4	17.78	15.24	12.25	7.00	2.96
87914-1434	-----	-----	-----	-----	14	-----	4	17.78	15.24	13.38	6.09	5.00
87914-1415	-----	-----	-----	-----	14	-----	5	17.78	15.24	10.92	5.84	2.79
87914-1425	-----	-----	-----	-----	14	-----	5	17.78	15.24	12.25	7.00	2.96
87914-1435	-----	-----	-----	-----	14	-----	5	17.78	15.24	13.38	6.09	5.00
87914-1416	-----	-----	-----	-----	14	-----	6	17.78	15.24	10.92	5.84	2.79
87914-1426	-----	-----	-----	-----	14	-----	6	17.78	15.24	12.25	7.00	2.96
87914-1436	-----	-----	-----	-----	14	-----	6	17.78	15.24	13.38	6.09	5.00
87914-0007	-----	-----	-----	-----	14	-----	6	17.78	15.24	13.42	8.08	3.05

THIS DRAWING CONTAINS INFORMATION THAT IS PROPRIETARY TO MOLEX ELECTRONIC TECHNOLOGIES, LLC AND SHOULD NOT BE USED WITHOUT WRITTEN PERMISSION

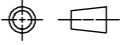
MIGRATED TO NX 2017/01/18 EC NO: 114466 DRWN: PKH CHK'D: 2017/03/15 APPR: ISHWARG	GENERAL TOLERANCES (UNLESS SPECIFIED)		DIMENSION UNITS		SCALE					
			MM	INCH	MM	NTS				
	4 PLACES	±	±	DRWN BY	DATE		2.54MM PITCH DUAL ROW HEADER SINGLE WAFER, T/H			
	3 PLACES	±	±	KCHO	2004/11/05					
	2 PLACES	± 0.2	±	CHK'D BY	DATE					
	1 PLACES	±	±	PTLIM	2004/12/08					
	0 PLACES	±	±	APPR BY	DATE		PRODUCT CUSTOMER DRAWING			
				MLONG	2010/09/06					
	ANGULAR TOL = 3.0			DRAWING SIZE	THIRD ANGLE PROJECTION		SERIES	MATERIAL NUMBER	CUSTOMER	
	DRAFT WHERE APPLICABLE MUST REMAIN WITHIN DIMENSIONS			A3			87914	SEE TABLE	GENERAL MARKET	
						DOCUMENT NUMBER	DOC TYPE	DOC PART	SHEET NUMBER	
						SD-87914-013	PSD	000	11 OF 45	

RELEASE STATUS	RELEASE DATE
----------------	--------------

PART NO FOR TRAY PACKAGING	PART NO. FOR TUBE WITHOUT CAP PACKAGING	PART NO. FOR TUBE WITH CAP PACKAGING	PART NO. FOR TAPE & REEL WITHOUT CAP PACKAGING	PART NO. FOR TAPE & REEL WITH CAP PACKAGING	CKT SIZE	VOID POSITION	PLATING TYPE	DIMENSION				
								A	B	F	M	P
87914-1611	-----	-----	-----	-----	16	-----	1	20.32	17.78	10.92	5.84	2.79
87914-1621	-----	-----	-----	-----	16	-----	1	20.32	17.78	12.25	7.00	2.96
87914-1631	-----	-----	-----	-----	16	-----	1	20.32	17.78	13.38	6.09	5.00
87914-1612	-----	-----	-----	-----	16	-----	2	20.32	17.78	10.92	5.84	2.79
87914-1622	-----	-----	-----	-----	16	-----	2	20.32	17.78	12.25	7.00	2.96
87914-1632	-----	-----	-----	-----	16	-----	2	20.32	17.78	13.38	6.09	5.00
87914-1613	-----	-----	-----	-----	16	-----	3	20.32	17.78	10.92	5.84	2.79
87914-1623	-----	-----	-----	-----	16	-----	3	20.32	17.78	12.25	7.00	2.96
87914-1633	-----	-----	-----	-----	16	-----	3	20.32	17.78	13.38	6.09	5.00
87914-1614	-----	-----	-----	-----	16	-----	4	20.32	17.78	10.92	5.84	2.79
87914-1624	-----	-----	-----	-----	16	-----	4	20.32	17.78	12.25	7.00	2.96
87914-1634	-----	-----	-----	-----	16	-----	4	20.32	17.78	13.38	6.09	5.00
87914-1615	-----	-----	-----	-----	16	-----	5	20.32	17.78	10.92	5.84	2.79
87914-1625	-----	-----	-----	-----	16	-----	5	20.32	17.78	12.25	7.00	2.96
87914-1635	-----	-----	-----	-----	16	-----	5	20.32	17.78	13.38	6.09	5.00
87914-1616	-----	-----	-----	-----	16	-----	6	20.32	17.78	10.92	5.84	2.79
87914-1626	-----	-----	-----	-----	16	-----	6	20.32	17.78	12.25	7.00	2.96
87914-1636	-----	-----	-----	-----	16	-----	6	20.32	17.78	13.38	6.09	5.00
87914-1600	-----	-----	-----	-----	16	-----	6	20.32	17.78	9.49	4.50	2.70
87914-1637	-----	-----	-----	-----	16	-----	6	20.32	17.78	15.79	10.45	3.05

THIS DRAWING CONTAINS INFORMATION THAT IS PROPRIETARY TO MOLEX ELECTRONIC TECHNOLOGIES, LLC AND SHOULD NOT BE USED WITHOUT WRITTEN PERMISSION

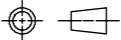
MIGRATED TO NX EC NO: 114466 DRWN: PKH CHK'D: ISHWARG APPR: ISHWARG REV:	2017/01/18	GENERAL TOLERANCES (UNLESS SPECIFIED)		DIMENSION UNITS		SCALE							
	2017/03/15	MM	INCH	MM	NTS								
	4 PLACES	±	±	DRWN BY	DATE	2.54MM PITCH DUAL ROW HEADER SINGLE WAFER, T/H							
	3 PLACES	±	±	KCHO	2004/11/05								
	2 PLACES	± 0.2	±	CHK'D BY	DATE								
	1 PLACES	±	±	PTLIM	2004/12/08								
	0 PLACES	±	±	APPR BY	DATE								
	ANGULAR TOL = 3.0		MLONG		2010/09/06	PRODUCT CUSTOMER DRAWING							
	DRAFT WHERE APPLICABLE MUST REMAIN WITHIN DIMENSIONS		DRAWING SIZE		THIRD ANGLE PROJECTION	SERIES		MATERIAL NUMBER		CUSTOMER			
	A3		A3			87914		SEE TABLE		GENERAL MARKET			
D17		A3		A3		DOCUMENT NUMBER		DOC TYPE		DOC PART		SHEET NUMBER	
						SD-87914-013		PSD		000		13 OF 45	

RELEASE STATUS	RELEASE DATE
----------------	--------------

PART NO FOR TRAY PACKAGING	PART NO. FOR TUBE WITHOUT CAP PACKAGING	PART NO. FOR TUBE WITH CAP PACKAGING	PART NO. FOR TAPE & REEL WITHOUT CAP PACKAGING	PART NO. FOR TAPE & REEL WITH CAP PACKAGING	CKT SIZE	VOID POSITION	PLATING TYPE	DIMENSION					
								A	B	F	M	P	G
87914-1811	-----	-----	-----	-----	18	-----	1	22.86	20.32	10.92	5.84	2.79	----
87914-1821	-----	-----	-----	-----	18	-----	1	22.86	20.32	12.25	7.00	2.96	----
87914-1831	-----	-----	-----	-----	18	-----	1	22.86	20.32	13.38	6.09	5.00	----
87914-1812	-----	-----	-----	-----	18	-----	2	22.86	20.32	10.92	5.84	2.79	----
87914-1822	-----	-----	-----	-----	18	-----	2	22.86	20.32	12.25	7.00	2.96	----
87914-1832	-----	-----	-----	-----	18	-----	2	22.86	20.32	13.38	6.09	5.00	----
87914-1813	-----	-----	-----	-----	18	-----	3	22.86	20.32	10.92	5.84	2.79	----
87914-1823	-----	-----	-----	-----	18	-----	3	22.86	20.32	12.25	7.00	2.96	----
87914-1833	-----	-----	-----	-----	18	-----	3	22.86	20.32	13.38	6.09	5.00	----
87914-1814	-----	-----	-----	-----	18	-----	4	22.86	20.32	10.92	5.84	2.79	----
87914-1824	-----	-----	-----	-----	18	-----	4	22.86	20.32	12.25	7.00	2.96	----
87914-1834	-----	-----	-----	-----	18	-----	4	22.86	20.32	13.38	6.09	5.00	----
87914-1815	-----	-----	-----	-----	18	-----	5	22.86	20.32	10.92	5.84	2.79	----
87914-1825	-----	-----	-----	-----	18	-----	5	22.86	20.32	12.25	7.00	2.96	----
87914-1835	-----	-----	-----	-----	18	-----	5	22.86	20.32	13.38	6.09	5.00	----
87914-1816	-----	-----	-----	-----	18	-----	6	22.86	20.32	10.92	5.84	2.79	----
87914-1826	-----	-----	-----	-----	18	-----	6	22.86	20.32	12.25	7.00	2.96	----
87914-1836	-----	-----	-----	-----	18	-----	6	22.86	20.32	13.38	6.09	5.00	----
-----	-----	87914-1807	-----	-----	18	-----	6	22.86	20.32	17.02	11.05	3.68	18.02

THIS DRAWING CONTAINS INFORMATION THAT IS PROPRIETARY TO MOLEX ELECTRONIC TECHNOLOGIES, LLC AND SHOULD NOT BE USED WITHOUT WRITTEN PERMISSION

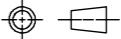
MIGRATED TO NX EC NO: 114466 DRWN: PKH CHK'D: REV APPR: ISHWARG	2017/01/18		2017/03/15		GENERAL TOLERANCES (UNLESS SPECIFIED)		DIMENSION UNITS		SCALE								
							MM INCH		MM NTS								
	4 PLACES		±		±		KCHO		DATE		2.54MM PITCH DUAL ROW HEADER SINGLE WAFER, T/H						
	3 PLACES		±		±		CHK'D BY		DATE								
	2 PLACES		± 0.2		±		PTLIM		DATE								
	1 PLACES		±		±		APPR BY		DATE		PRODUCT CUSTOMER DRAWING						
	0 PLACES		±		±		MLONG		DATE								
							ANGULAR TOL = 3.0		DRAWING SIZE		THIRD ANGLE PROJECTION		SERIES	MATERIAL NUMBER		CUSTOMER	
							DRAFT WHERE APPLICABLE MUST REMAIN WITHIN DIMENSIONS		A3				87914	SEE TABLE		GENERAL MARKET	
	D17												DOCUMENT NUMBER		DOC TYPE	DOC PART	SHEET NUMBER
												SD-87914-013		PSD	000	14 OF 45	

RELEASE STATUS	RELEASE DATE
----------------	--------------

PART NO FOR TRAY PACKAGING	PART NO. FOR TUBE WITHOUT CAP PACKAGING	PART NO. FOR TUBE WITH CAP PACKAGING	PART NO. FOR TAPE & REEL WITHOUT CAP PACKAGING	PART NO. FOR TAPE & REEL WITH CAP PACKAGING	CKT SIZE	VOID POSITION	PLATING TYPE	DIMENSION				
								A	B	F	M	P
87914-3611	-----	-----	-----	-----	36	-----	1	45.72	43.18	10.92	5.84	2.79
87914-3621	-----	-----	-----	-----	36	-----	1	45.72	43.18	12.25	7.00	2.96
87914-3631	-----	-----	-----	-----	36	-----	1	45.72	43.18	13.38	6.09	5.00
87914-3612	-----	-----	-----	-----	36	-----	2	45.72	43.18	10.92	5.84	2.79
87914-3622	-----	-----	-----	-----	36	-----	2	45.72	43.18	12.25	7.00	2.96
87914-3632	-----	-----	-----	-----	36	-----	2	45.72	43.18	13.38	6.09	5.00
87914-3613	-----	-----	-----	-----	36	-----	3	45.72	43.18	10.92	5.84	2.79
87914-3623	-----	-----	-----	-----	36	-----	3	45.72	43.18	12.25	7.00	2.96
87914-3633	-----	-----	-----	-----	36	-----	3	45.72	43.18	13.38	6.09	5.00
87914-3614	-----	-----	-----	-----	36	-----	4	45.72	43.18	10.92	5.84	2.79
87914-3624	-----	-----	-----	-----	36	-----	4	45.72	43.18	12.25	7.00	2.96
87914-3634	-----	-----	-----	-----	36	-----	4	45.72	43.18	13.38	6.09	5.00
87914-3615	-----	-----	-----	-----	36	-----	5	45.72	43.18	10.92	5.84	2.79
87914-3625	-----	-----	-----	-----	36	-----	5	45.72	43.18	12.25	7.00	2.96
87914-3635	-----	-----	-----	-----	36	-----	5	45.72	43.18	13.38	6.09	5.00
87914-3616	-----	-----	-----	-----	36	-----	6	45.72	43.18	10.92	5.84	2.79
87914-3626	-----	-----	-----	-----	36	-----	6	45.72	43.18	12.25	7.00	2.96
87914-3636	-----	-----	-----	-----	36	-----	6	45.72	43.18	13.38	6.09	5.00
87914-3637	-----	-----	-----	-----	36	-----	6	45.72	43.18	12.10	7.01	2.60

THIS DRAWING CONTAINS INFORMATION THAT IS PROPRIETARY TO MOLEX ELECTRONIC TECHNOLOGIES, LLC AND SHOULD NOT BE USED WITHOUT WRITTEN PERMISSION

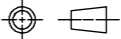
MIGRATED TO NX EC NO: 114466 DRWN: PKH CHK'D: ISHWARG REV APPR: ISHWARG	GENERAL TOLERANCES (UNLESS SPECIFIED)		DIMENSION UNITS		SCALE				
			MM	INCH	MM	NTS			
	4 PLACES ±		MM	INCH	DRWN BY	DATE	2.54MM PITCH DUAL ROW HEADER SINGLE WAFER, T/H		
	3 PLACES ±				KCHO	2004/11/05			
	2 PLACES ± 0.2				CHK'D BY	DATE			
	1 PLACES ±				PTLIM	2004/12/08			
	0 PLACES ±				APPR BY	DATE			
	ANGULAR TOL = 3.0				MLONG	2010/09/06	PRODUCT CUSTOMER DRAWING		
	DRAFT WHERE APPLICABLE MUST REMAIN WITHIN DIMENSIONS				DRAWING SIZE	THIRD ANGLE PROJECTION	SERIES	MATERIAL NUMBER	CUSTOMER
					A3		87914	SEE TABLE	GENERAL MARKET
						DOCUMENT NUMBER	DOC TYPE	DOC PART	SHEET NUMBER
						SD-87914-013	PSD	000	23 OF 45

RELEASE STATUS	RELEASE DATE
----------------	--------------

PART NO FOR TRAY PACKAGING	PART NO. FOR TUBE WITHOUT CAP PACKAGING	PART NO. FOR TUBE WITH CAP PACKAGING	PART NO. FOR TAPE & REEL WITHOUT CAP PACKAGING	PART NO. FOR TAPE & REEL WITH CAP PACKAGING	CKT SIZE	VOID POSITION	PLATING TYPE	DIMENSION				
								A	B	F	M	P
87914-5011	-----	-----	-----	-----	50	-----	1	63.50	60.96	10.92	5.84	2.79
87914-5021	-----	-----	-----	-----	50	-----	1	63.50	60.96	12.25	7.00	2.96
87914-5012	-----	-----	-----	-----	50	-----	2	63.50	60.96	10.92	5.84	2.79
87914-5022	-----	-----	-----	-----	50	-----	2	63.50	60.96	12.25	7.00	2.96
87914-5013	-----	-----	-----	-----	50	-----	3	63.50	60.96	10.92	5.84	2.79
87914-5023	-----	-----	-----	-----	50	-----	3	63.50	60.96	12.25	7.00	2.96
87914-5014	-----	-----	-----	-----	50	-----	4	63.50	60.96	10.92	5.84	2.79
87914-5024	-----	-----	-----	-----	50	-----	4	63.50	60.96	12.25	7.00	2.96
87914-5015	-----	-----	-----	-----	50	-----	5	63.50	60.96	10.92	5.84	2.79
87914-5025	-----	-----	-----	-----	50	-----	5	63.50	60.96	12.25	7.00	2.96
87914-5016	-----	-----	-----	-----	50	-----	6	63.50	60.96	10.92	5.84	2.79
87914-5026	-----	-----	-----	-----	50	-----	6	63.50	60.96	12.25	7.00	2.96
87914-0002	-----	-----	-----	-----	50	-----	8	63.50	60.96	18.54	11.58	4.47

THIS DRAWING CONTAINS INFORMATION THAT IS PROPRIETARY TO MOLEX ELECTRONIC TECHNOLOGIES, LLC AND SHOULD NOT BE USED WITHOUT WRITTEN PERMISSION

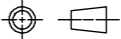
MIGRATED TO NX EC NO: 114466 DRWN: PKH CHK'D: ISHWARG APPR: ISHWARG REV:	2017/01/18	GENERAL TOLERANCES (UNLESS SPECIFIED)		DIMENSION UNITS		SCALE						
	2017/03/15	MM	INCH	MM	INCH	NTS	NTS					
	4 PLACES	±	±	DRWN BY	DATE		2.54MM PITCH DUAL ROW HEADER SINGLE WAFER, T/H					
	3 PLACES	±	±	KCHO	2004/11/05							
	2 PLACES	± 0.2	±	CHK'D BY	DATE							
	1 PLACES	±	±	PTLIM	2004/12/08							
	0 PLACES	±	±	APPR BY	DATE		PRODUCT CUSTOMER DRAWING					
	ANGULAR TOL = 3.0			MLONG	2010/09/06		SERIES	MATERIAL NUMBER	CUSTOMER			
	DRAFT WHERE APPLICABLE MUST REMAIN WITHIN DIMENSIONS			DRAWING SIZE	THIRD ANGLE PROJECTION		87914	SEE TABLE	GENERAL MARKET			
				A3			DOCUMENT NUMBER	DOC TYPE	DOC PART	SHEET NUMBER		
						SD-87914-013	PSD	000	30 OF 45			

RELEASE STATUS	RELEASE DATE
----------------	--------------

PART NO FOR BULK PACKAGING	PART NO. FOR TUBE WITHOUT CAP PACKAGING	PART NO. FOR TUBE WITH CAP PACKAGING	PART NO. FOR TAPE & REEL WITHOUT CAP PACKAGING	PART NO. FOR TAPE & REEL WITH CAP PACKAGING	CKT SIZE	VOID POSITION	PLATING TYPE	DIMENSION				
								A	B	F	M	P
87914-6411	-----	-----	-----	-----	64	-----	1	81.28	78.74	10.92	5.84	2.79
87914-6421	-----	-----	-----	-----	64	-----	1	81.28	78.74	12.25	7.00	2.96
87914-6412	-----	-----	-----	-----	64	-----	2	81.28	78.74	10.92	5.84	2.79
87914-6422	-----	-----	-----	-----	64	-----	2	81.28	78.74	12.25	7.00	2.96
87914-6413	-----	-----	-----	-----	64	-----	3	81.28	78.74	10.92	5.84	2.79
87914-6423	-----	-----	-----	-----	64	-----	3	81.28	78.74	12.25	7.00	2.96
87914-6414	-----	-----	-----	-----	64	-----	4	81.28	78.74	10.92	5.84	2.79
87914-6424	-----	-----	-----	-----	64	-----	4	81.28	78.74	12.25	7.00	2.96
87914-6415	-----	-----	-----	-----	64	-----	5	81.28	78.74	10.92	5.84	2.79
87914-6425	-----	-----	-----	-----	64	-----	5	81.28	78.74	12.25	7.00	2.96
87914-6416	-----	-----	-----	-----	64	-----	6	81.28	78.74	10.92	5.84	2.79
87914-6426	-----	-----	-----	-----	64	-----	6	81.28	78.74	12.25	7.00	2.96

THIS DRAWING CONTAINS INFORMATION THAT IS PROPRIETARY TO MOLEX ELECTRONIC TECHNOLOGIES, LLC AND SHOULD NOT BE USED WITHOUT WRITTEN PERMISSION

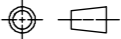
MIGRATED TO NX EC NO: 114466 DRWN: PKH CHK'D: ISHWARG APPR: ISHWARG 2017/01/18 2017/03/15	GENERAL TOLERANCES (UNLESS SPECIFIED)		DIMENSION UNITS		SCALE					
		MM	INCH	MM	NTS					
	4 PLACES	±	±	DRWN BY		DATE		2.54MM PITCH DUAL ROW HEADER SINGLE WAFER, T/H		
	3 PLACES	±	±	KCHO		2004/11/05				
	2 PLACES	± 0.2	±	CHK'D BY		DATE				
	1 PLACES	±	±	PTLIM		2004/12/08				
	0 PLACES	±	±	APPR BY		DATE				
	ANGULAR TOL = 3.0			MLONG		2010/09/06		PRODUCT CUSTOMER DRAWING		
	DRAFT WHERE APPLICABLE MUST REMAIN WITHIN DIMENSIONS			DRAWING SIZE		THIRD ANGLE PROJECTION		SERIES: 87914 MATERIAL NUMBER: SEE TABLE CUSTOMER: GENERAL MARKET		
				A3				DOCUMENT NUMBER: SD-87914-013 DOC TYPE: PSD DOC PART: 000 SHEET NUMBER: 37 OF 45		

RELEASE STATUS	RELEASE DATE
----------------	--------------

PART NO FOR BULK PACKAGING	PART NO. FOR TUBE WITHOUT CAP PACKAGING	PART NO. FOR TUBE WITH CAP PACKAGING	PART NO. FOR TAPE & REEL WITHOUT CAP PACKAGING	PART NO. FOR TAPE & REEL WITH CAP PACKAGING	CKT SIZE	VOID POSITION	PLATING TYPE	DIMENSION				
								A	B	F	M	P
87914-8011	-----	-----	-----	-----	80	-----	1	101.60	99.06	10.92	5.84	2.79
87914-8021	-----	-----	-----	-----	80	-----	1	101.60	99.06	12.25	7.00	2.96
87914-8012	-----	-----	-----	-----	80	-----	2	101.60	99.06	10.92	5.84	2.79
87914-8022	-----	-----	-----	-----	80	-----	2	101.60	99.06	12.25	7.00	2.96
87914-8013	-----	-----	-----	-----	80	-----	3	101.60	99.06	10.92	5.84	2.79
87914-8023	-----	-----	-----	-----	80	-----	3	101.60	99.06	12.25	7.00	2.96
87914-8014	-----	-----	-----	-----	80	-----	4	101.60	99.06	10.92	5.84	2.79
87914-8024	-----	-----	-----	-----	80	-----	4	101.60	99.06	12.25	7.00	2.96
87914-8015	-----	-----	-----	-----	80	-----	5	101.60	99.06	10.92	5.84	2.79
87914-8025	-----	-----	-----	-----	80	-----	5	101.60	99.06	12.25	7.00	2.96
87914-8016	-----	-----	-----	-----	80	-----	6	101.60	99.06	10.92	5.84	2.79
87914-8026	-----	-----	-----	-----	80	-----	6	101.60	99.06	12.25	7.00	2.96

THIS DRAWING CONTAINS INFORMATION THAT IS PROPRIETARY TO MOLEX ELECTRONIC TECHNOLOGIES, LLC AND SHOULD NOT BE USED WITHOUT WRITTEN PERMISSION

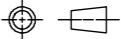
MIGRATED TO NX EC NO: 114466 DRWN: PKH CHK'D: REV APPR: ISHWARG	2017/01/18		2017/03/15		GENERAL TOLERANCES (UNLESS SPECIFIED)		DIMENSION UNITS		SCALE					
							MM INCH		MM NTS					
	4 PLACES		±		±		KCHO		DATE		2.54MM PITCH DUAL ROW HEADER SINGLE WAFER, T/H			
	3 PLACES		±		±		CHK'D BY		DATE					
	2 PLACES		± 0.2		±		PTLIM		DATE					
	1 PLACES		±		±		APPR BY		DATE		PRODUCT CUSTOMER DRAWING			
	0 PLACES		±		±		MLONG		DATE					
	ANGULAR TOL = 3.0						DRAWING SIZE		THIRD ANGLE PROJECTION		SERIES	MATERIAL NUMBER		CUSTOMER
	DRAFT WHERE APPLICABLE MUST REMAIN WITHIN DIMENSIONS						A3				87914	SEE TABLE		GENERAL MARKET
	D17	REV									DOCUMENT NUMBER		DOC TYPE	DOC PART
										SD-87914-013		PSD	000	45 OF 45

RELEASE STATUS	RELEASE DATE
----------------	--------------