

IRLZ34NS/L

HEXFET® Power MOSFET

- Logic-Level Gate Drive
- Advanced Process Technology
- Surface Mount (IRLZ34NS)
- Low-profile through-hole (IRLZ34NL)
- 175°C Operating Temperature
- Fast Switching
- Fully Avalanche Rated



$V_{DSS} = 55V$
 $R_{DS(on)} = 0.035\Omega$
 $I_D = 30A$

Description

Fifth Generation HEXFETs from International Rectifier utilize advanced processing techniques to achieve extremely low on-resistance per silicon area. This benefit, combined with the fast switching speed and ruggedized device design that HEXFET Power MOSFETs are well known for, provides the designer with an extremely efficient and reliable device for use in a wide variety of applications.

The D²Pak is a surface mount power package capable of accommodating die sizes up to HEX-4. It provides the highest power capability and the lowest possible on-resistance in any existing surface mount package. The D²Pak is suitable for high current applications because of its low internal connection resistance and can dissipate up to 2.0W in a typical surface mount application. The through-hole version (IRLZ34NL) is available for low-profile applications.



Absolute Maximum Ratings

| | Parameter | Max. | Units |
|---------------------------|--|------------------------|-------|
| $I_D @ T_C = 25^\circ C$ | Continuous Drain Current, $V_{GS} @ 10V$ ⑤ | 30 | A |
| $I_D @ T_C = 100^\circ C$ | Continuous Drain Current, $V_{GS} @ 10V$ ⑤ | 21 | |
| I_{DM} | Pulsed Drain Current ①⑤ | 110 | |
| $P_D @ T_A = 25^\circ C$ | Power Dissipation | 3.8 | W |
| $P_D @ T_C = 25^\circ C$ | Power Dissipation | 68 | W |
| | Linear Derating Factor | 0.45 | W/°C |
| V_{GS} | Gate-to-Source Voltage | ±16 | V |
| E_{AS} | Single Pulse Avalanche Energy②⑤ | 110 | mJ |
| I_{AR} | Avalanche Current① | 16 | A |
| E_{AR} | Repetitive Avalanche Energy① | 6.8 | mJ |
| dv/dt | Peak Diode Recovery dv/dt ③⑤ | 5.0 | V/ns |
| T_J | Operating Junction and | -55 to + 175 | °C |
| T_{STG} | Storage Temperature Range | | |
| | Soldering Temperature, for 10 seconds | 300 (1.6mm from case) | |

Thermal Resistance

| | Parameter | Typ. | Max. | Units |
|-----------------|--|------|------|-------|
| $R_{\theta JC}$ | Junction-to-Case | — | 2.2 | °C/W |
| $R_{\theta JA}$ | Junction-to-Ambient (PCB Mounted, steady-state)** | — | 40 | |

Electrical Characteristics @ T_J = 25°C (unless otherwise specified)

| | Parameter | Min. | Typ. | Max. | Units | Conditions |
|--|--------------------------------------|------|-------|-------|-------|---|
| V _{(BR)DSS} | Drain-to-Source Breakdown Voltage | 55 | — | — | V | V _{GS} = 0V, I _D = 250μA |
| ΔV _{(BR)DSS} /ΔT _J | Breakdown Voltage Temp. Coefficient | — | 0.065 | — | V/°C | Reference to 25°C, I _D = 1mA ^⑤ |
| R _{DS(on)} | Static Drain-to-Source On-Resistance | — | — | 0.035 | Ω | V _{GS} = 10V, I _D = 16A ^④ |
| | | — | — | 0.046 | | V _{GS} = 5.0V, I _D = 16A ^④ |
| | | — | — | 0.060 | | V _{GS} = 4.0V, I _D = 14A ^④ |
| V _{GS(th)} | Gate Threshold Voltage | 1.0 | — | 2.0 | V | V _{DS} = V _{GS} , I _D = 250μA |
| g _{fs} | Forward Transconductance | 11 | — | — | S | V _{DS} = 25V, I _D = 16A ^⑤ |
| I _{DSS} | Drain-to-Source Leakage Current | — | — | 25 | μA | V _{DS} = 55V, V _{GS} = 0V |
| | | — | — | 250 | | V _{DS} = 44V, V _{GS} = 0V, T _J = 150°C |
| I _{GSS} | Gate-to-Source Forward Leakage | — | — | 100 | nA | V _{GS} = 16V |
| | Gate-to-Source Reverse Leakage | — | — | -100 | | V _{GS} = -16V |
| Q _g | Total Gate Charge | — | — | 25 | nC | I _D = 16A |
| Q _{gs} | Gate-to-Source Charge | — | — | 5.2 | | V _{DS} = 44V |
| Q _{gd} | Gate-to-Drain ("Miller") Charge | — | — | 14 | | V _{GS} = 5.0V, See Fig. 6 and 13 ^{④⑤} |
| t _{d(on)} | Turn-On Delay Time | — | 8.9 | — | ns | V _{DD} = 28V |
| t _r | Rise Time | — | 100 | — | | I _D = 16A |
| t _{d(off)} | Turn-Off Delay Time | — | 21 | — | | R _G = 6.5Ω, V _{GS} = 5.0V |
| t _f | Fall Time | — | 29 | — | | R _D = 1.8Ω, See Fig. 10 ^{④⑤} |
| L _S | Internal Source Inductance | — | 7.5 | — | nH | Between lead, and center of die contact |
| C _{iss} | Input Capacitance | — | 880 | — | pF | V _{GS} = 0V |
| C _{oss} | Output Capacitance | — | 220 | — | | V _{DS} = 25V |
| C _{rss} | Reverse Transfer Capacitance | — | 94 | — | | f = 1.0MHz, See Fig. 5 ^⑤ |

Source-Drain Ratings and Characteristics

| | Parameter | Min. | Typ. | Max. | Units | Conditions |
|-----------------|--|--|------|------|-------|--|
| I _S | Continuous Source Current (Body Diode) | — | — | 30 | A | MOSFET symbol showing the integral reverse p-n junction diode. |
| I _{SM} | Pulsed Source Current (Body Diode) ^① | — | — | 110 | | |
| V _{SD} | Diode Forward Voltage | — | — | 1.3 | V | T _J = 25°C, I _S = 16A, V _{GS} = 0V ^④ |
| t _{rr} | Reverse Recovery Time | — | 76 | 110 | ns | T _J = 25°C, I _F = 16A |
| Q _{rr} | Reverse Recovery Charge | — | 190 | 290 | nC | di/dt = 100A/μs ^{④⑤} |
| t _{on} | Forward Turn-On Time | Intrinsic turn-on time is negligible (turn-on is dominated by L _S +L _D) | | | | |

Notes:

- ① Repetitive rating; pulse width limited by max. junction temperature. (See fig. 11)
- ② V_{DD} = 25V, starting T_J = 25°C, L = 610μH
R_G = 25Ω, I_{AS} = 16A. (See Figure 12)
- ③ I_{SD} ≤ 16A, di/dt ≤ 270A/μs, V_{DD} ≤ V_{(BR)DSS},
T_J ≤ 175°C
- ④ Pulse width ≤ 300μs; duty cycle ≤ 2%.
- ⑤ Uses IRLZ34N data and test conditions

** When mounted on 1" square PCB (FR-4 or G-10 Material).
For recommended footprint and soldering techniques refer to application note #AN-994.

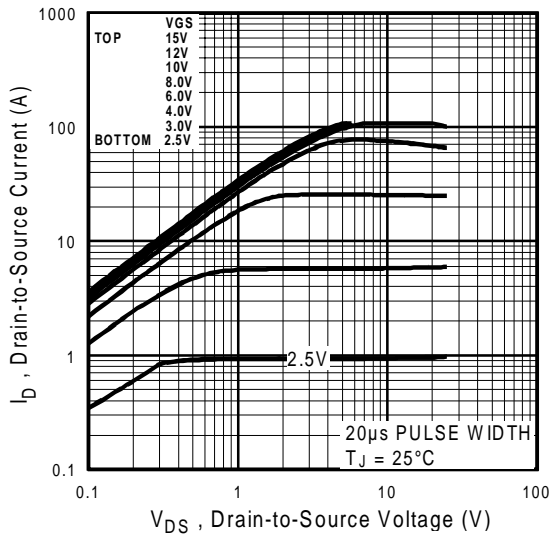

Fig 1. Typical Output Characteristics

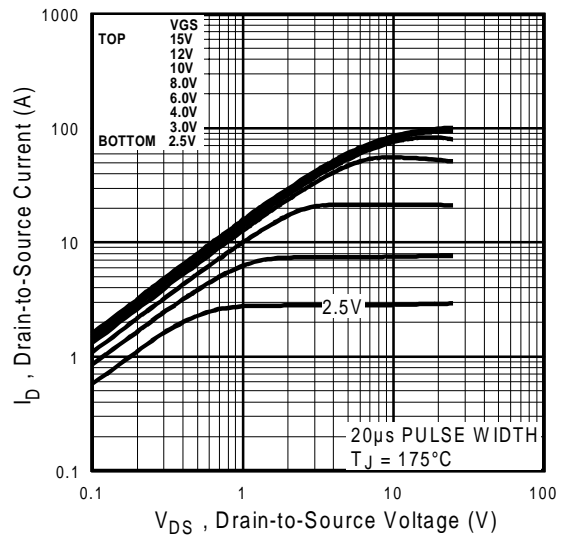

Fig 2. Typical Output Characteristics

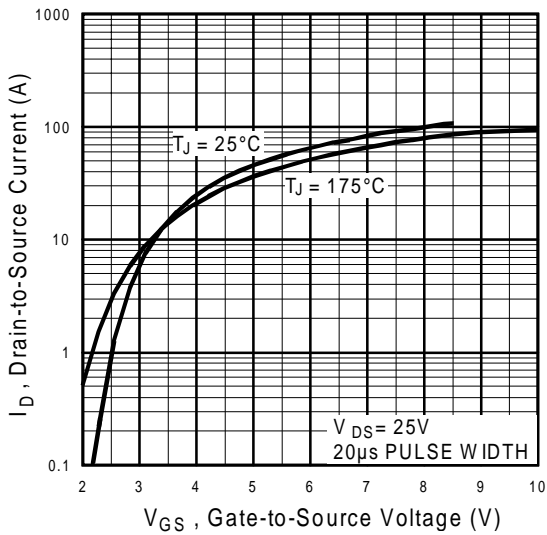

Fig 3. Typical Transfer Characteristics

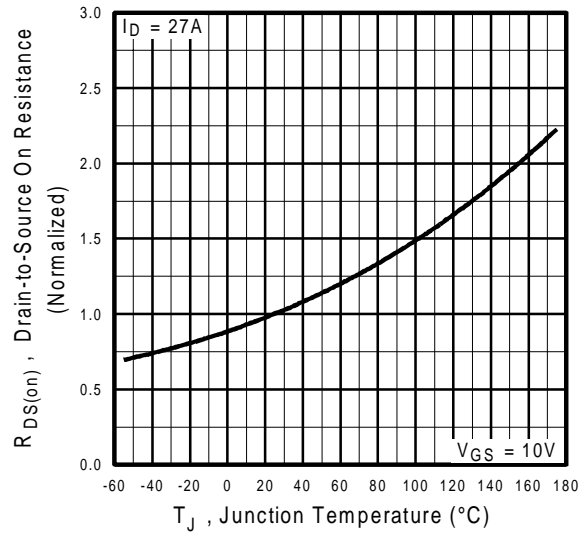

Fig 4. Normalized On-Resistance Vs. Temperature

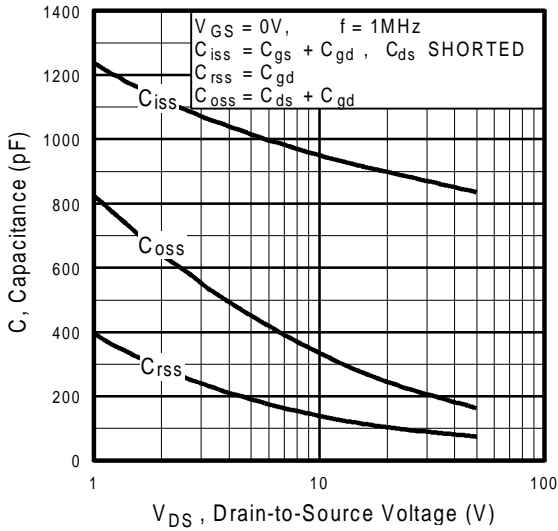

Fig 5. Typical Capacitance Vs. Drain-to-Source Voltage

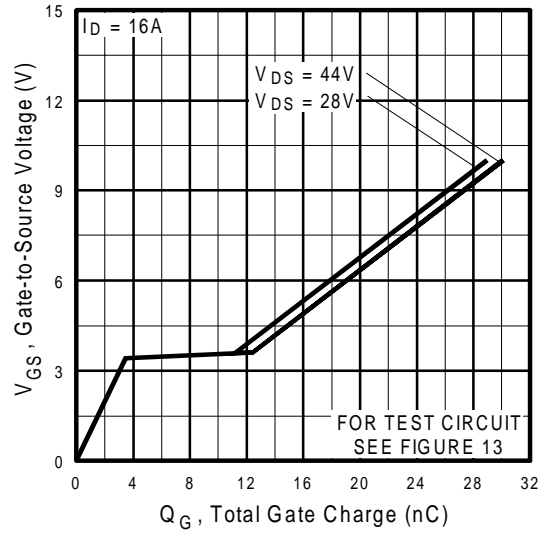

Fig 6. Typical Gate Charge Vs. Gate-to-Source Voltage

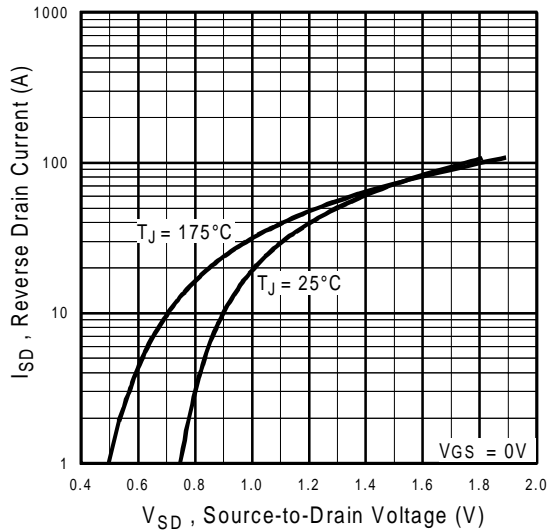

Fig 7. Typical Source-Drain Diode Forward Voltage

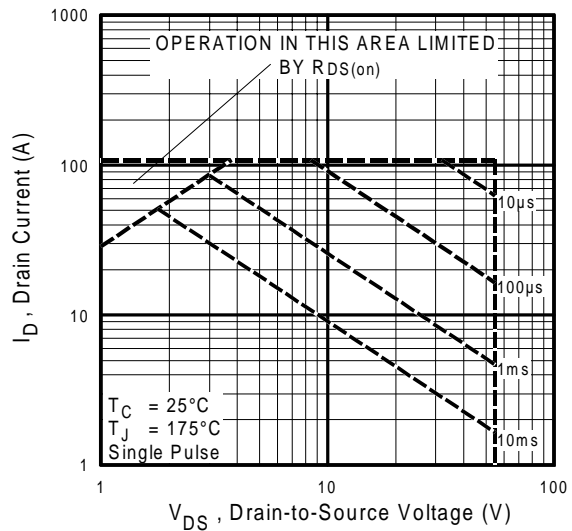

Fig 8. Maximum Safe Operating Area

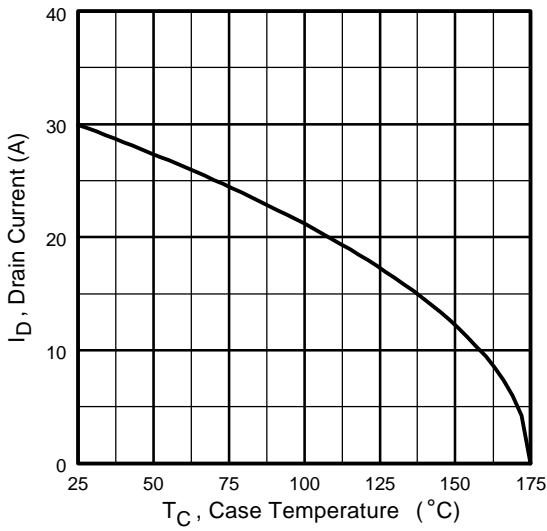

Fig 9. Maximum Drain Current vs. Case Temperature

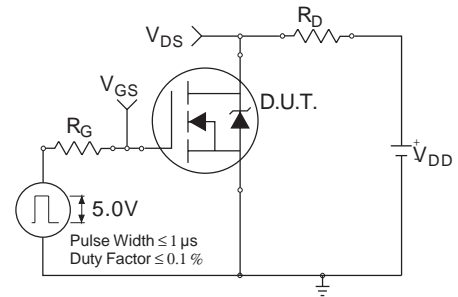

Fig 10a. Switching Time Test Circuit

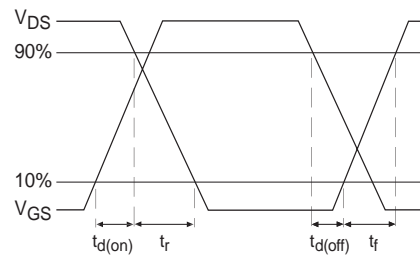

Fig 10b. Switching Time Waveforms

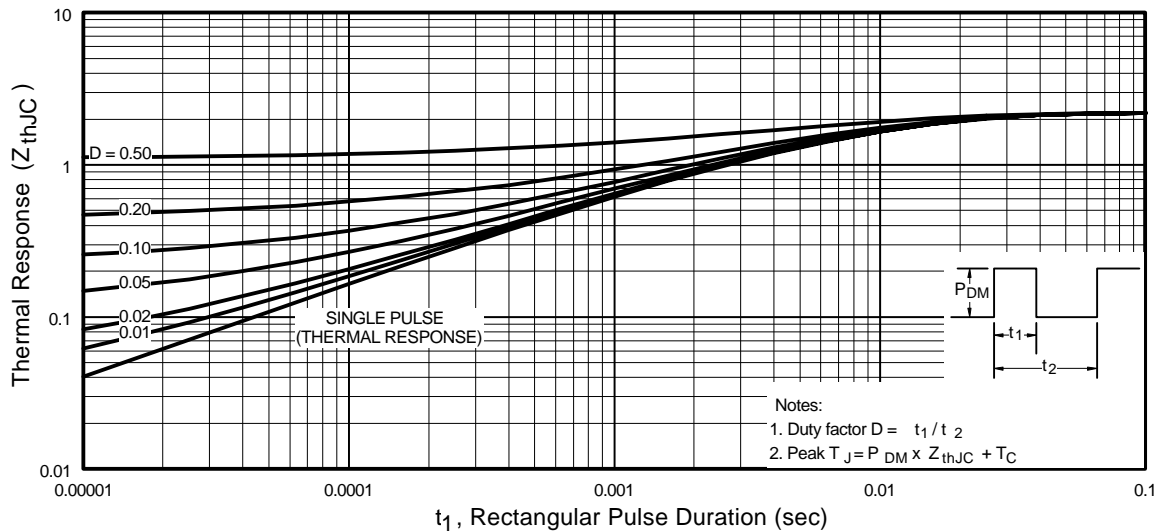

Fig 11. Maximum Effective Transient Thermal Impedance, Junction-to-Case

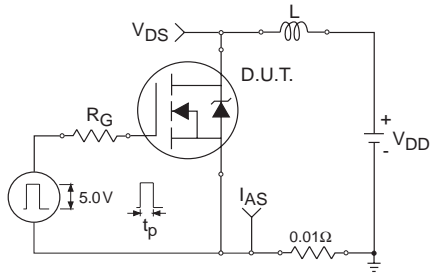

Fig 12a. Unclamped Inductive Test Circuit

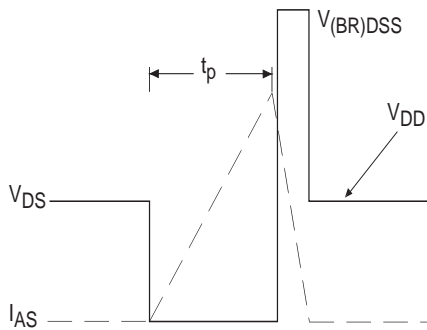

Fig 12b. Unclamped Inductive Waveforms

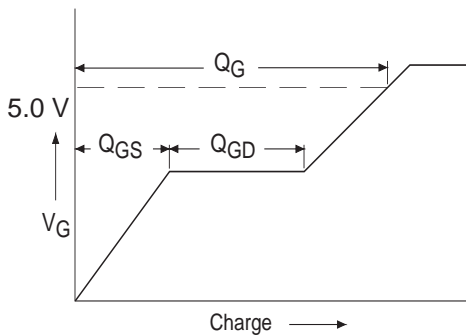

Fig 13a. Basic Gate Charge Waveform

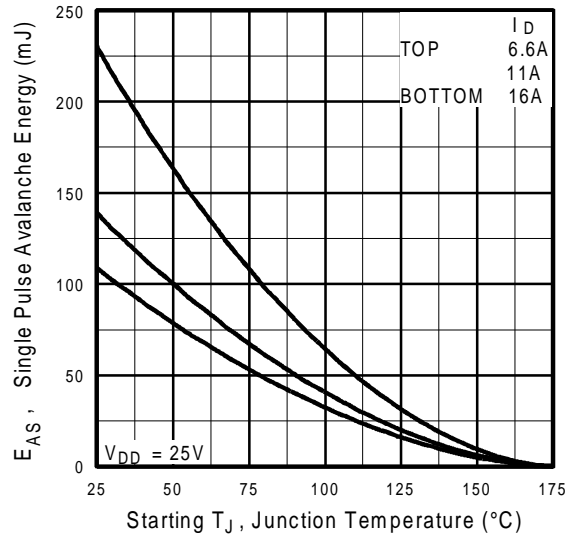

Fig 12c. Maximum Avalanche Energy Vs. Drain Current

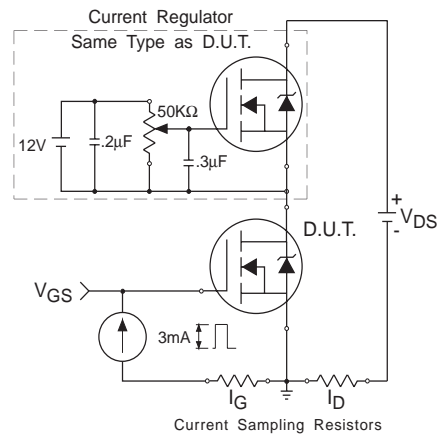

Fig 13b. Gate Charge Test Circuit

Peak Diode Recovery dv/dt Test Circuit



* $V_{GS} = 5V$ for Logic Level Devices

Fig 14. For N-Channel HEXFETS

IRLZ34NS/L

International
IOR Rectifier

D²Pak Package Outline



Part Marking Information

D²Pak

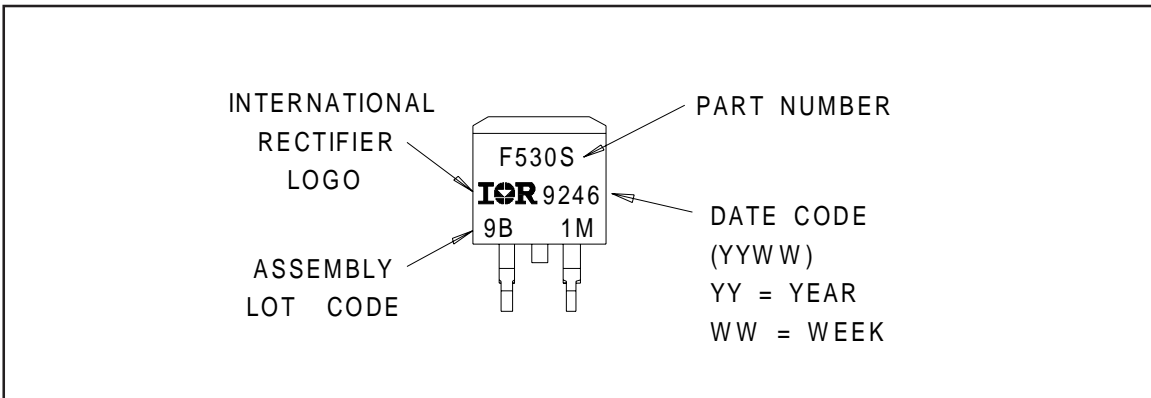

Package Outline

TO-262 Outline



Part Marking Information

TO-262

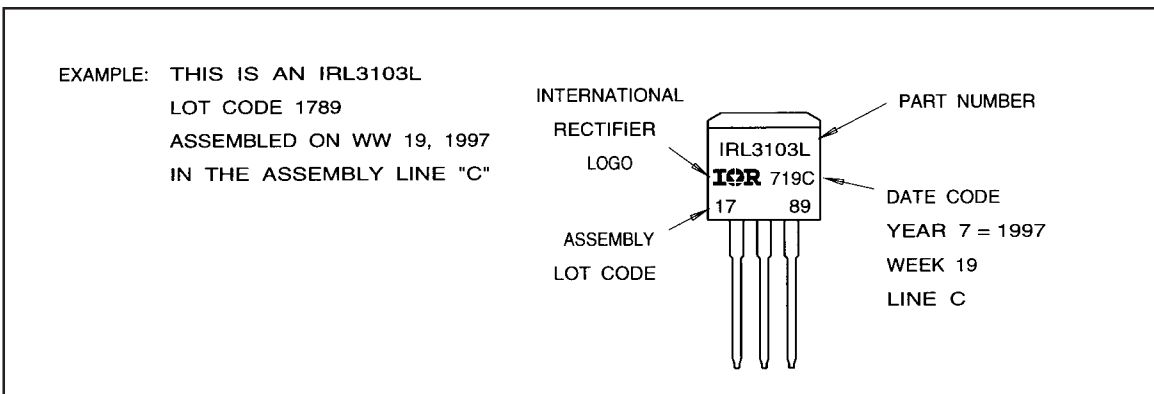

IRLZ34NS/L

International
IR Rectifier

Tape & Reel Information

D²Pak



International
IR Rectifier

WORLD HEADQUARTERS: 233 Kansas St., El Segundo, California 90245, Tel: (310) 322 3331
EUROPEAN HEADQUARTERS: Hurst Green, Oxted, Surrey RH8 9BB, UK Tel: ++ 44 1883 732020

IR CANADA: 7321 Victoria Park Ave., Suite 201, Markham, Ontario L3R 2Z8, Tel: (905) 475 1897

IR GERMANY: Saalburgstrasse 157, 61350 Bad Homburg Tel: ++ 49 6172 96590

IR ITALY: Via Liguria 49, 10071 Borgaro, Torino Tel: ++ 39 11 451 0111

IR FAR EAST: K&H Bldg., 2F, 30-4 Nishi-Ikebukuro 3-Chome, Toshima-Ku, Tokyo Japan 171 Tel: 81 3 3983 0086

IR SOUTHEAST ASIA: 315 Outram Road, #10-02 Tan Boon Liat Building, Singapore 0316 Tel: 65 221 8371

<http://www.irf.com/> Data and specifications subject to change without notice. 5/98

Note: For the most current drawings please refer to the IR website at:
<http://www.irf.com/package/>