

8 ROW
10 POSITION
SHOWN

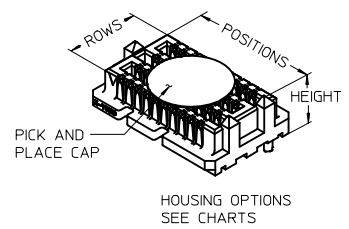

POSITION	
10	0.15/.006
20	0.15/.006
30	0.15/.006
40	0.15/.006
50	0.15/.006
15	0.15/.006
25	0.15/.006
35	0.23/.009
45	0.23/.009

NOTES:

- MATERIAL: HOUSING: LCP, GLASS FILLED, UL94V-0, BLACK
CONTACTS: COPPER ALLOY
SOLDER CHARGE: 63 % TIN, 37% LEAD
- FINISH: ALL DIM P HEIGHT OPTIONS - SELECT GOLD IN CONTACT AREA: 30 MI MIN
DIM P HEIGHT OPTIONS 2.0 & 2.5: SELECT GOLD FLASH IN TAIL, 7 MI MIN
DIM P HEIGHT OPTIONS 3.0 THRU 7.0: SELECT TIN IN TAIL, 50 MI MIN
ALL DIM P HEIGHT OPTIONS - NICKEL UNDERPLATE OVERALL
- PRODUCT SPECIFICATION: PS-45970-001
- PACKAGING SPECIFICATION: TAPE AND REEL PACK PK-45971-002
- MATES WITH SEARAY RECEPTACLE ASSY 45971
- APPLICATION SPECIFICATION: AS-45970-001
- COSMETIC SPECIFICATION: PS-45499-002 CLASS B
- PART STATUS: CONTACT MOLEX

SEE SHEET 3
FOR 6 ROW OPTION

INITIAL RELEASE EC NO: UCP2015-1206 DRAWN: RWHIPPLE 2014/10/24 CHKD: DMORGAN 2014/10/24 APPR: SMILLER 2015/01/05	QUALITY SYMBOLS	GENERAL TOLERANCES (UNLESS SPECIFIED)	DIMENSION STYLE	SCALE	DESIGN UNITS	THIRD ANGLE PROJECTION
	$\nabla F=0$ $\nabla E=0$ $\nabla D=0$	mm INCH 4 PLACES ± --- ± --- 3 PLACES ± --- ± .010 2 PLACES ± 0.25 ± .015 1 PLACE ± 0.38 ± --- 0 PLACE ± ±	MM/IN	3:1	INCH	
	DESCRIPTION	ANGULAR ± --- ° DRAFT WHERE APPLICABLE MUST REMAIN WITHIN DIMENSIONS	DRAWN BY DATE	TITLE		
	REV		CHECKED BY DATE	SEARAY PLUG ASSEMBLY .050 CENTERS, TIN/LEAD		
		APPROVED BY DATE	SEE TABLE SHT 4	DOCUMENT NO.		
		MATERIAL NO.	SIZE B	RSD-45970-001	SHEET NO.	
			THIS DRAWING CONTAINS INFORMATION THAT IS PROPRIETARY TO MOLEX INCORPORATED AND SHOULD NOT BE USED WITHOUT WRITTEN PERMISSION			

10 9 8 7 6 5 4 3 2 1

F
E
D
C
B
A

6 ROW
10 POSITION
SHOWN

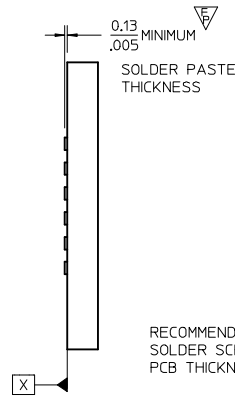
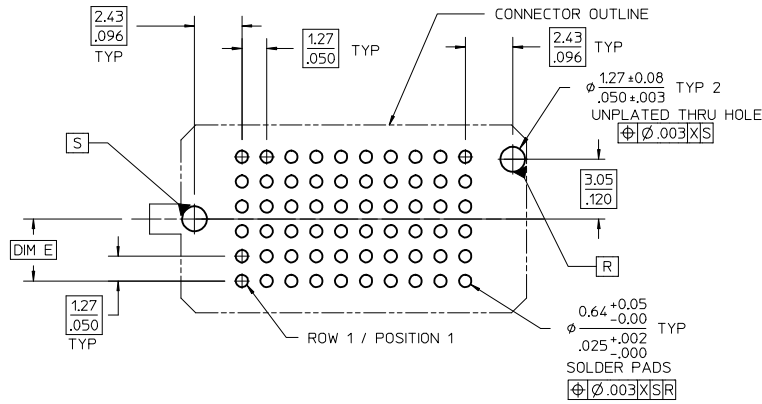

NO OF ROWS	DIM C	DIM E
6	.960/.378	.317/.125
8	1.21/.478	.444/.175
10	1.47/.578	5.72/.225

		DIM R RECEPTACLE STACK HEIGHT					
		MM	5.0	6.0	6.5	7.5	8.0
DIM P PLUG STACK HEIGHT	2.0	7.0	8.0	8.5	9.5	10.0	
	3.0	8.0	9.0	9.5	10.5	11.0	
	3.5	8.5	9.5	10.0	11.0	11.5	
	2.5	7.5	8.5	9.0	10.0	10.5	
	4.5	9.5	10.5	11.0	12.0	12.5	
	5.0	10.0	11.0	11.5	12.5	13.0	
	7.0	12.0	13.0	13.5	14.5	15.0	
	9.0	14.0	15.0	15.5	16.5	17.0	

MATED STACK HEIGHTS
GIVEN IN MILLIMETERS (MM) FOR REFERENCE ONLY

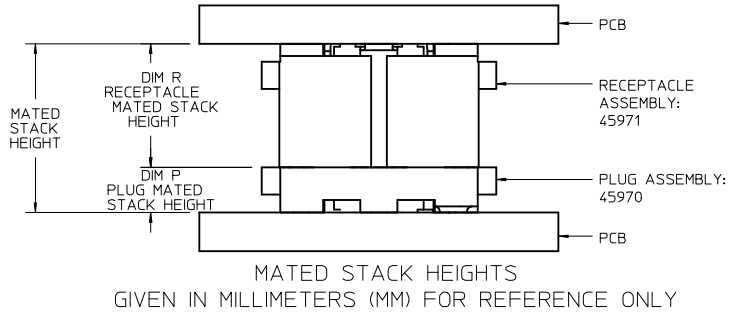

SEE SHEET 1 EC NO: UCP2015-1206 DRAWN: RWHIPPLE 2014/10/24 CHKD: DMORGAN 2014/10/24 APPR: SMILLER 2015/01/05 REV A	QUALITY SYMBOLS	GENERAL TOLERANCES (UNLESS SPECIFIED)	DIMENSION STYLE	SCALE	DESIGN UNITS	THIRD ANGLE PROJECTION
	$\nabla F=0$	mm INCH	MM/IN	4:1	INCH	
	$\nabla F=2$	4 PLACES ± --- ± --- 3 PLACES ± --- ± .010 2 PLACES ± 0.25 ± .015 1 PLACE ± 0.38 ± --- 0 PLACE ± ±	DRAWN BY DATE RWHIPPLE 2014/10/24 CHECKED BY DATE DMORGAN 2014/10/24 APPROVED BY DATE SMILLER 2015/01/05	TITLE	SEARAY PLUG ASSEMBLY .050 CENTERS, TIN/LEAD	
	$\nabla F=0$	ANGULAR ± --- ° DRAFT WHERE APPLICABLE MUST REMAIN WITHIN DIMENSIONS	MATERIAL NO. SEE TABLE SHT 4 SIZE B	DOCUMENT NO. RSD-45970-001	SHEET NO. 2 OF 4	

THIS DRAWING CONTAINS INFORMATION THAT IS PROPRIETARY TO MOLEX INCORPORATED AND SHOULD NOT BE USED WITHOUT WRITTEN PERMISSION

10 9 8 7 6 5 4 3 2 1

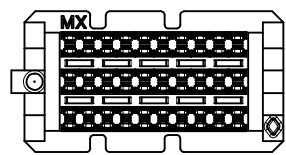
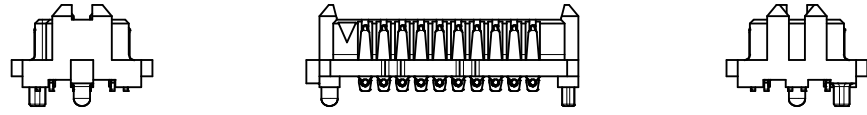
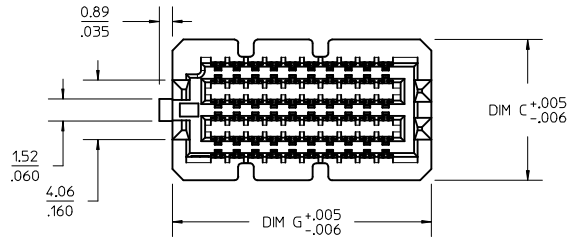

6 ROW OPTION

60 CKT VERSION
 SHOWN FOR REFERENCE.
 DIMENSIONS SHOWN ON
 OTHER SHEETS APPLY TO
 THE 6 ROW OPTION ALSO
 (EXCEPT AS OTHERWISE
 NOTED ON THIS SHEET)

SEE SHEET 1 EC NO: UCP2015-1206 DRAWN: RWHIPPLE 2014/10/24 CHKD: DMORGAN 2014/10/24 APPR: SMILLER 2015/01/05	DESCRIPTION REV A	QUALITY SYMBOLS	GENERAL TOLERANCES (UNLESS SPECIFIED)	DIMENSION STYLE	SCALE	DESIGN UNITS	THIRD ANGLE PROJECTION	
		$\nabla Z=0$ $\nabla E=0$ $\nabla F=0$	mm INCH 4 PLACES ± --- ± --- 3 PLACES ± --- ± .010 2 PLACES ± 0.25 ± .015 1 PLACE ± 0.38 ± --- 0 PLACE ± ±	MM/IN	3:1	INCH	DRAWN BY DATE RWHIPPLE 2014/10/24 CHECKED BY DATE DMORGAN 2014/10/24 APPROVED BY DATE SMILLER 2015/01/05	TITLE SEARAY PLUG ASSEMBLY .050 CENTERS, TIN/LEAD molex DOCUMENT NO. RSD-45970-001 SHEET NO. 3 OF 4
		ANGULAR ± --- ° DRAFT WHERE APPLICABLE MUST REMAIN WITHIN DIMENSIONS	MATERIAL NO.	SEE TABLE SHT 4				
		SIZE B	THIS DRAWING CONTAINS INFORMATION THAT IS PROPRIETARY TO MOLEX INCORPORATED AND SHOULD NOT BE USED WITHOUT WRITTEN PERMISSION					

9 8 7 6 5 4 3 2 1

ROWS: 6

DIM P:		2.0 MM	3.0 MM	3.5 MM	2.5 MM	4.5 MM	5.0 MM	7.0 MM
DIM H:		5.61/.221	6.60/.260	7.11/.280	6.12/.241	8.10/.319	8.61/.339	10.61/.418
POSITION	DIM G	MATERIAL NO	MATERIAL NO	MATERIAL NO	MATERIAL NO	MATERIAL NO	MATERIAL NO	MATERIAL NO
10	17.68/0.696	45970-1167	45970-1267	45970-1367	45970-1467	45970-1567	45970-1667	45970-1767
20	30.37/1.196	45970-2167	45970-2267	45970-2367	45970-2467	45970-2567	45970-2667	45970-2767
30	43.07/1.696	45970-3167	45970-3267	45970-3367	45970-3467	45970-3567	45970-3667	45970-3767
40	55.77/2.196	45970-4167	45970-4267	45970-4367	45970-4467	45970-4567	45970-4667	45970-4767
50	68.48/2.696	45970-5167	45970-5267	45970-5367	45970-5467	45970-5567	45970-5667	45970-5767
15	24.02/0.946	45970-6167	45970-6267	45970-6367	45970-6467	45970-6567	45970-6667	45970-6767
25	36.72/1.446	45970-7167	45970-7267	45970-7367	45970-7467	45970-7567	45970-7667	45970-7767
35	49.42/1.946	45970-8167	45970-8267	45970-8367	45970-8467	45970-8567	45970-8667	45970-8767
45	62.13/2.446	45970-9167	45970-9267	45970-9367	45970-9467	45970-9567	45970-9667	45970-9767

ROWS: 8

DIM P:		2.0 MM	3.0 MM	3.5 MM	2.5 MM	4.5 MM	5.0 MM	7.0 MM
DIM H:		5.61/.221	6.60/.260	7.11/.280	6.12/.241	8.10/.319	8.61/.339	10.61/.418
POSITION	DIM G	MATERIAL NO	MATERIAL NO	MATERIAL NO	MATERIAL NO	MATERIAL NO	MATERIAL NO	MATERIAL NO
10	17.68/0.696	45970-1187	45970-1287	45970-1387	45970-1487	45970-1587	45970-1687	45970-1787
20	30.37/1.196	45970-2187	45970-2287	45970-2387	45970-2487	45970-2587	45970-2687	45970-2787
30	43.07/1.696	45970-3187	45970-3287	45970-3387	45970-3487	45970-3587	45970-3687	45970-3787
40	55.77/2.196	45970-4187	45970-4287	45970-4387	45970-4487	45970-4587	45970-4687	45970-4787
50	68.48/2.696	45970-5187	45970-5287	45970-5387	45970-5487	45970-5587	45970-5687	45970-5787
15	24.02/0.946	45970-6187	45970-6287	45970-6387	45970-6487	45970-6587	45970-6687	45970-6787
25	36.72/1.446	45970-7187	45970-7287	45970-7387	45970-7487	45970-7587	45970-7687	45970-7787
35	49.42/1.946	45970-8187	45970-8287	45970-8387	45970-8487	45970-8587	45970-8687	45970-8787
45	62.13/2.446	45970-9187	45970-9287	45970-9387	45970-9487	45970-9587	45970-9687	45970-9787

ROWS: 10

DIM P:		2.0 MM	3.0 MM	3.5 MM	2.5 MM	4.5 MM	5.0 MM	7.0 MM	9.0 MM
DIM H:		5.61/.221	6.60/.260	7.11/.280	6.12/.241	8.10/.319	8.61/.339	10.61/.418	12.62/.497
POSITION	DIM G	MATERIAL NO	MATERIAL NO	MATERIAL NO	MATERIAL NO	MATERIAL NO	MATERIAL NO	MATERIAL NO	MATERIAL NO
10	17.68/0.696	45970-1117	45970-1217	45970-1317	45970-1417	45970-1517	45970-1617	45970-1717	45970-1917
20	30.37/1.196	45970-2117	45970-2217	45970-2317	45970-2417	45970-2517	45970-2617	45970-2717	45970-2917
30	43.07/1.696	45970-3117	45970-3217	45970-3317	45970-3417	45970-3517	45970-3617	45970-3717	45970-3917
40	55.77/2.196	45970-4117	45970-4217	45970-4317	45970-4417	45970-4517	45970-4617	45970-4717	45970-4917
50	68.48/2.696	45970-5117	45970-5217	45970-5317	45970-5417	45970-5517	45970-5617	45970-5717	45970-5917
15	24.02/0.946	45970-6117	45970-6217	45970-6317	45970-6417	45970-6517	45970-6617	45970-6717	45970-6917
25	36.72/1.446	45970-7117	45970-7217	45970-7317	45970-7417	45970-7517	45970-7617	45970-7717	45970-7917
35	49.42/1.946	45970-8117	45970-8217	45970-8317	45970-8417	45970-8517	45970-8617	45970-8717	45970-8917
45	62.13/2.446	45970-9117	45970-9217	45970-9317	45970-9417	45970-9517	45970-9617	45970-9717	45970-9917

MATED STACK HEIGHTS
GIVEN IN MILLIMETERS (MM) FOR REFERENCE ONLY

SEE SHEET 1 EC NO: UCP2015-1206 DRAWN BY: RWHIPPLE 2014/10/24 CHKD: DMORGAN 2014/10/24 APPR: SMILLER 2015/01/05	DESCRIPTION REV A	QUALITY SYMBOLS	GENERAL TOLERANCES (UNLESS SPECIFIED)	DIMENSION STYLE	SCALE	DESIGN UNITS	THIRD ANGLE PROJECTION	
		$\nabla F=0$ $\nabla E=0$ $\nabla D=0$	mm INCH 4 PLACES ± --- ± --- 3 PLACES ± --- ± .010 2 PLACES ± 0.25 ± .015 1 PLACE ± 0.38 ± --- 0 PLACE ± ±	MM/IN	4:1	INCH	DRAWN BY: RWHIPPLE DATE: 2014/10/24 CHECKED BY: DMORGAN DATE: 2014/10/24 APPROVED BY: SMILLER DATE: 2015/01/05	TITLE
			ANGULAR ± ---° DRAFT WHERE APPLICABLE MUST REMAIN WITHIN DIMENSIONS	SEE TABLES MATERIAL NO.	RSD-45970-001 DOCUMENT NO.	SEARAY PLUG ASSEMBLY .050 CENTERS, TIN/LEAD molex	SHEET NO.	
				THIS DRAWING CONTAINS INFORMATION THAT IS PROPRIETARY TO MOLEX INCORPORATED AND SHOULD NOT BE USED WITHOUT WRITTEN PERMISSION	4 OF 4			

NOTES:

1. MATERIAL: HOUSING: GLASS FILLED LCP (LIQUID CRYSTAL POLYMER), UL94V-0, BLACK
CONTACTS: COPPER ALLOY
SOLDER CHARGE: 95.5% TIN, 3.8% SILVER, 0.7% COPPER
2. FINISH: ALL DIM P HEIGHT OPTIONS - SELECT GOLD IN CONTACT AREA; 30 MICRONCH MINIMUM
DIM P HEIGHT OPTIONS 2.0 & 2.5: SELECT GOLD FLASH ON TAIL, 7 MICRONCH MINIMUM
DIM P HEIGHT OPTIONS 3.0 THRU 7.0: SELECT TIN ON TAIL, 50 MICRONCH MINIMUM
ALL OPTIONS - NICKEL UNDERPLATE OVERALL ON TAIL
3. PRODUCT SPECIFICATION: PS-45970-001
4. PACKAGING SPECIFICATION: PK-45971-002 (TAPE AND REEL)
5. MATES WITH SEARAY RECEPTACLE ASSEMBLY SERIES 45971
6. APPLICATION SPECIFICATION: AS-45970-001
7. COSMETIC SPECIFICATION: PS-45499-002 CLASS B
8. PART STATUS: CONTACT MOLEX

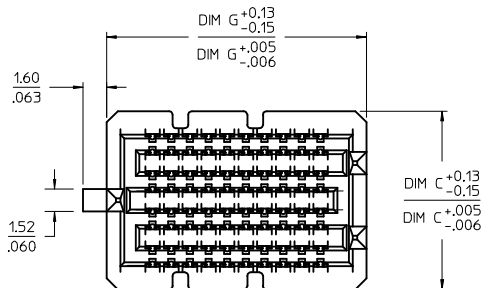

8 ROW
10 POSITION
SHOWN

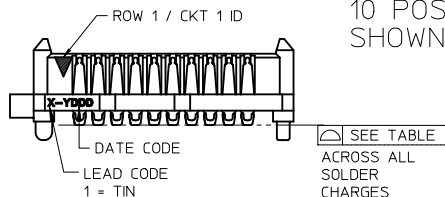

SEE TABLE
ACROSS ALL
SOLDER
CHARGES

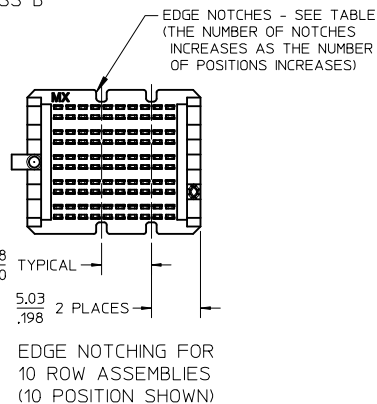
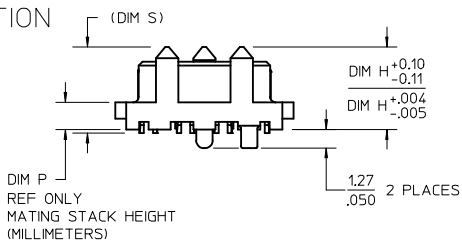

POSITIONS	TOTAL NUMBER OF EDGE NOTCHES		Diameter
	8 ROW	6 AND 10 ROW	
10	4	4	0.15/.006
15	6	6	
20	10	10	
25	12	12	
30	14	14	
35	16	16	0.23/.009
40	18	20	
45	22	22	
50	24	24	

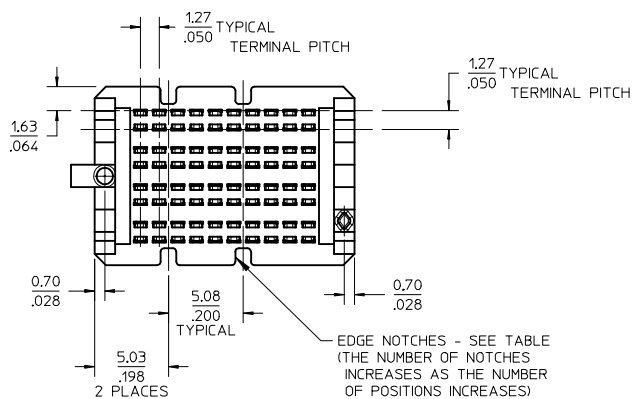

SEE OTHER EDGE NOTCHING VIEWS

SEE SHEET 3
FOR 6 ROW OPTION

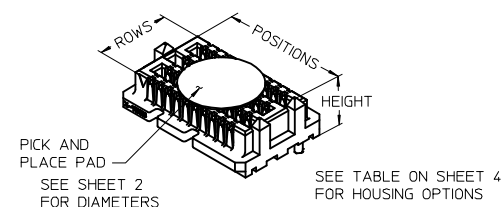
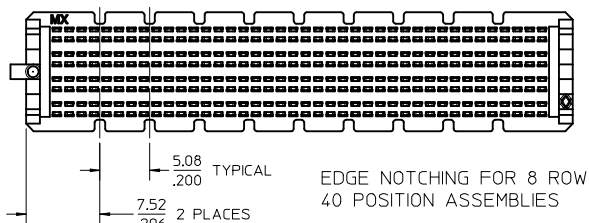

SEE TABLE ON SHEET 4
FOR HOUSING OPTIONS

ADD REF DIM S @ D7 EC NO: UCP2016-3194 DRAWN: TPROMO 2016/02/15 CHKD: PTEO 2016/02/16 APPR: DMCCOWAN 2016/02/16	QUALITY SYMBOLS F=0 F=0 F=0	GENERAL TOLERANCES (UNLESS SPECIFIED) <table border="1"> <thead> <tr> <th></th> <th>mm</th> <th>INCH</th> </tr> </thead> <tbody> <tr> <td>4 PLACES</td> <td>± ---</td> <td>± ---</td> </tr> <tr> <td>3 PLACES</td> <td>± ---</td> <td>± .010</td> </tr> <tr> <td>2 PLACES</td> <td>± 0.25</td> <td>± .015</td> </tr> <tr> <td>1 PLACE</td> <td>± 0.38</td> <td>± ---</td> </tr> <tr> <td>0 PLACE</td> <td>±</td> <td>±</td> </tr> </tbody> </table>		mm	INCH	4 PLACES	± ---	± ---	3 PLACES	± ---	± .010	2 PLACES	± 0.25	± .015	1 PLACE	± 0.38	± ---	0 PLACE	±	±	DIMENSION STYLE MM/IN	SCALE 3:1	DESIGN UNITS INCH	THIRD ANGLE PROJECTION
		mm	INCH																					
	4 PLACES	± ---	± ---																					
	3 PLACES	± ---	± .010																					
2 PLACES	± 0.25	± .015																						
1 PLACE	± 0.38	± ---																						
0 PLACE	±	±																						
DRAWN BY: TGREGORI CHECKED BY: BBARKER APPROVED BY: JCOMERCI	DATE: 2005/01/27 DATE: 2014/08/07 DATE: 2010/03/05	ANGULAR ± ---° DRAFT WHERE APPLICABLE MUST REMAIN WITHIN DIMENSIONS	MATERIAL NO. SEE TABLE SHT 4	TITLE SEARAY PLUG ASSEMBLY 1.27/.050 CENTERS molex	DOCUMENT NO. SD-45970-001	SHEET NO. 1 OF 5																		
SIZE B	THIS DRAWING CONTAINS INFORMATION THAT IS PROPRIETARY TO MOLEX INCORPORATED AND SHOULD NOT BE USED WITHOUT WRITTEN PERMISSION																							

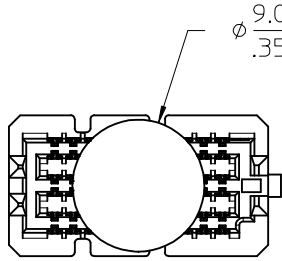

6 ROW OPTION

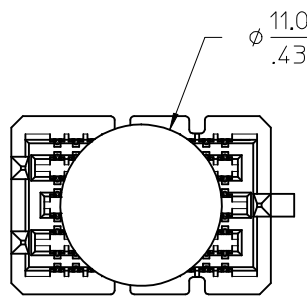

8 ROW OPTION

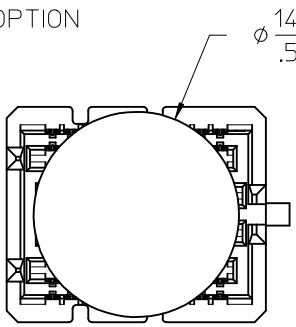

10 ROW OPTION

PICK AND PLACE
PAD DIAMETERS
10 POSITION VERSIONS SHOWN

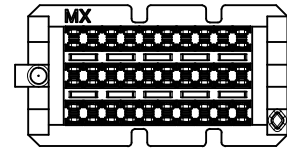
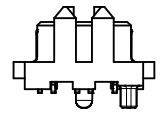
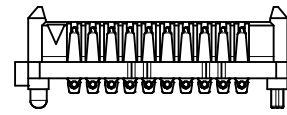
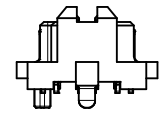
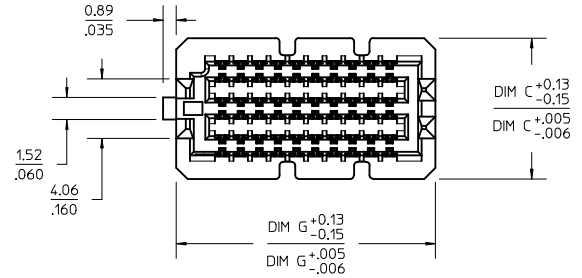

6 ROW OPTION

10 POSITION VERSION
SHOWN FOR REFERENCE

DIMENSIONS SHOWN ON
OTHER SHEETS APPLY TO
THE 6 ROW OPTION ALSO
(EXCEPT AS OTHERWISE
NOTED ON THIS SHEET)

SEE SHEET 1 ELC NO: UCP2016-3194 DRWN:TPREMO 2016/02/15 CHKD:PTCO 2016/02/16 APPR:DMCGOWAN 2016/02/16 T2	QUALITY SYMBOLS	GENERAL TOLERANCES (UNLESS SPECIFIED)	DIMENSION STYLE	SCALE	DESIGN UNITS	THIRD ANGLE PROJECTION
	▽=0	mm INCH	MM/IN	3:1	INCH	◎
	▽=0	4 PLACES ± --- ± ---	DRAWN BY DATE	TITLE	SEARAY PLUG ASSEMBLY 1.27/.050 CENTERS	
	▽=0	3 PLACES ± --- ± .010	TGREGORI 2005/01/27			
▽=0	2 PLACES ± 0.25 ± .015	CHECKED BY DATE	DOCUMENT NO.		SHEET NO.	
	1 PLACE ± 0.38 ± ---	APPROVED BY DATE	SD-45970-001		2 OF 5	
	0 PLACE ± ±	JCOMERC I 2010/03/05	MATERIAL NO.			
	ANGULAR ± --- °		SEE TABLE SHT 4			
	DRAFT WHERE APPLICABLE MUST REMAIN WITHIN DIMENSIONS		SIZE B			
			THIS DRAWING CONTAINS INFORMATION THAT IS PROPRIETARY TO MOLEX INCORPORATED AND SHOULD NOT BE USED WITHOUT WRITTEN PERMISSION			

10 9 8 7 6 5 4 3 2 1

6 ROW
10 POSITION
SHOWN

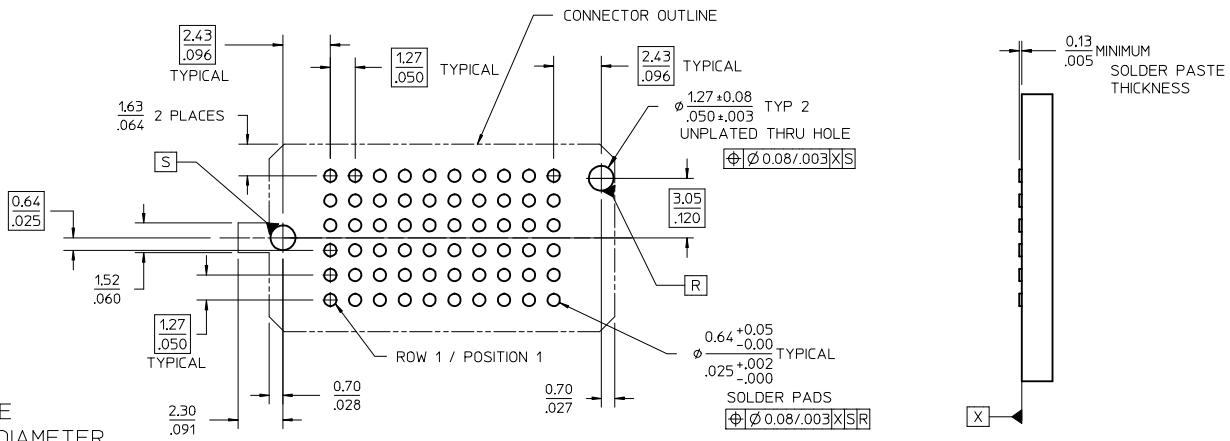

RECOMMENDED PCB LAYOUT: COMPONENT SIDE
SOLDER SCREEN APERTURE SIZE: .890/.035 DIAMETER
PCB THICKNESS: NA

		DIM R RECEPTACLE STACK HEIGHT					
		MM	5.0	6.0	6.5	7.5	8.0
DIM P PLUG STACK HEIGHT	2.0	7.0	8.0	8.5	9.5	10.0	
	3.0	8.0	9.0	9.5	10.5	11.0	
	3.5	8.5	9.5	10.0	11.0	11.5	
	2.5	7.5	8.5	9.0	10.0	10.5	
	4.5	9.5	10.5	11.0	12.0	12.5	
	5.0	10.0	11.0	11.5	12.5	13.0	
	7.0	12.0	13.0	13.5	14.5	15.0	
9.0	14.0	15.0	15.5	16.5	17.0		

MATED STACK HEIGHTS
GIVEN IN MILLIMETERS (MM) FOR REFERENCE ONLY

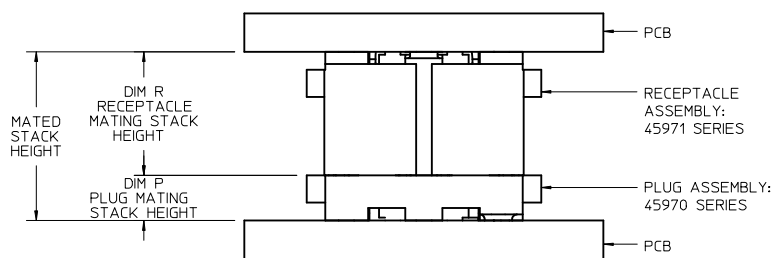

STACK HEIGHTS
GIVEN IN MILLIMETERS (MM) FOR REFERENCE ONLY

SEE SHEET 1 EC NO: UCP2016-3194 DRAWN: TPREMO 2016/02/15 CHKD: PTEO 2016/02/16 APPR: DMCGOWAN 2016/02/16 REV T2	QUALITY SYMBOLS ▽/0 ▽/0 ▽/0	GENERAL TOLERANCES (UNLESS SPECIFIED)		DIMENSION STYLE		SCALE	DESIGN UNITS	THIRD ANGLE PROJECTION		
			mm	INCH	MM/IN		4:1	INCH		
		4 PLACES	± ---	± ---	DRAWN BY	DATE	TITLE			
		3 PLACES	± ---	± .010	TGREGORI	2005/01/27	SEARAY PLUG ASSEMBLY 1.27/.050 CENTERS			
	2 PLACES	± 0.25	± .015	CHECKED BY	DATE	DOCUMENT NO. SD-45970-001				
	1 PLACE	± 0.38	± ---	BBARKER	2014/08/07					SHEET NO. 3 OF 5
	0 PLACE	±	±	APPROVED BY	DATE	THIS DRAWING CONTAINS INFORMATION THAT IS PROPRIETARY TO MOLEX INCORPORATED AND SHOULD NOT BE USED WITHOUT WRITTEN PERMISSION				
				JCOMERCI	2010/03/05					MATERIAL NO. SEE TABLE SHT 4
						ANGULAR ± --- ° DRAFT WHERE APPLICABLE MUST REMAIN WITHIN DIMENSIONS				
										SIZE B

9 8 7 6 5 4 3 2 1

ROWS: 6 DIMENSION C = 9.60/.378

DIM P:	2.0 MM	3.0 MM	3.5 MM	2.5 MM	4.5 MM	5.0 MM	7.0 MM	
DIM H:	5.61/.221	6.60/.260	7.11/.280	6.12/.241	8.10/.319	8.61/.339	10.61/.418	
DIM S:	5.86/.231	6.85/.270	7.36/.290	6.37/.251	8.35/.329	8.86/.349	10.86/.428	
POSITION	DIM G	MATERIAL NO	MATERIAL NO	MATERIAL NO	MATERIAL NO	MATERIAL NO	MATERIAL NO	MATERIAL NO
10	17.69/0.698	45970-1165	45970-1265	45970-1365	45970-1465	45970-1565	45970-1665	45970-1765
20	30.39/1.198	45970-2165	45970-2265	45970-2365	45970-2465	45970-2565	45970-2665	45970-2765
30	43.09/1.698	45970-3165	45970-3265	45970-3365	45970-3465	45970-3565	45970-3665	45970-3765
40	55.79/2.198	45970-4165	45970-4265	45970-4365	45970-4465	45970-4565	45970-4665	45970-4765
50	68.49/2.698	45970-5165	45970-5265	45970-5365	45970-5465	45970-5565	45970-5665	45970-5765
15	24.04/0.948	45970-6165	45970-6265	45970-6365	45970-6465	45970-6565	45970-6665	45970-6765
25	36.74/1.448	45970-7165	45970-7265	45970-7365	45970-7465	45970-7565	45970-7665	45970-7765
35	49.44/1.948	45970-8165	45970-8265	45970-8365	45970-8465	45970-8565	45970-8665	45970-8765
45	62.14/2.448	45970-9165	45970-9265	45970-9365	45970-9465	45970-9565	45970-9665	45970-9765

ROWS: 8 DIMENSION C = 12.14/.478

DIM P:	2.0 MM	3.0 MM	3.5 MM	2.5 MM	4.5 MM	5.0 MM	7.0 MM	
DIM H:	5.61/.221	6.60/.260	7.11/.280	6.12/.241	8.10/.319	8.61/.339	10.61/.418	
DIM S:	5.86/.231	6.85/.270	7.36/.290	6.37/.251	8.35/.329	8.86/.349	10.86/.428	
POSITION	DIM G	MATERIAL NO	MATERIAL NO	MATERIAL NO	MATERIAL NO	MATERIAL NO	MATERIAL NO	MATERIAL NO
10	17.69/0.698	45970-1185	45970-1285	45970-1385	45970-1485	45970-1585	45970-1685	45970-1785
20	30.39/1.198	45970-2185	45970-2285	45970-2385	45970-2485	45970-2585	45970-2685	45970-2785
30	43.09/1.698	45970-3185	45970-3285	45970-3385	45970-3485	45970-3585	45970-3685	45970-3785
40	55.79/2.198	45970-4185	45970-4285	45970-4385	45970-4485	45970-4585	45970-4685	45970-4785
50	68.49/2.698	45970-5185	45970-5285	45970-5385	45970-5485	45970-5585	45970-5685	45970-5785
15	24.04/0.948	45970-6185	45970-6285	45970-6385	45970-6485	45970-6585	45970-6685	45970-6785
25	36.74/1.448	45970-7185	45970-7285	45970-7385	45970-7485	45970-7585	45970-7685	45970-7785
35	49.44/1.948	45970-8185	45970-8285	45970-8385	45970-8485	45970-8585	45970-8685	45970-8785
45	62.14/2.448	45970-9185	45970-9285	45970-9385	45970-9485	45970-9585	45970-9685	45970-9785

MATING STACK HEIGHTS (DIMENSION P)
GIVEN IN MILLIMETERS (MM) FOR REFERENCE ONLY

SEE SHEET 1 EC NO: UCP2016-3194 DRAWN: TPREMO 2016/02/15 CHKD: PTEO 2016/02/16 APPR: DMCCOWAN 2016/02/16 T2	QUALITY SYMBOLS	GENERAL TOLERANCES (UNLESS SPECIFIED)	DIMENSION STYLE	SCALE	DESIGN UNITS	THIRD ANGLE PROJECTION	
	$\nabla F=0$ $\nabla E=0$ $\nabla D=0$	mm INCH 4 PLACES ± --- ± --- 3 PLACES ± --- ± .010 2 PLACES ± 0.25 ± .015 1 PLACE ± 0.38 ± --- 0 PLACE ± ±	MM/IN	4:1	INCH		
	DESCRIPTION	ANGULAR ± ---°	DRAWN BY	DATE	TITLE		
		DRAFT WHERE APPLICABLE MUST REMAIN WITHIN DIMENSIONS	TGREGORI	2005/01/27	SEARAY PLUG ASSEMBLY 1.27/.050 CENTERS		
		APPROVED BY	DATE	DOCUMENT NO.		SHEET NO.	
		JCOMERCI	2010/03/05	SD-45970-001		4 OF 5	
		MATERIAL NO.				THIS DRAWING CONTAINS INFORMATION THAT IS PROPRIETARY TO MOLEX INCORPORATED AND SHOULD NOT BE USED WITHOUT WRITTEN PERMISSION	
		SEE TABLES					

10 9 8 7 6 5 4 3 2 1

ROWS: 10 DIMENSION C = 14.68/.578

DIM P:	2.0 MM	3.0 MM	3.5 MM	2.5 MM	4.5 MM	5.0 MM	7.0 MM	9.0 MM	
DIM H:	5.61/.221	6.60/.260	7.11/.280	6.12/.241	8.10/.319	8.61/.339	10.61/.418	12.62/.497	
DIM S:	5.86/.231	6.85/.270	7.36/.290	6.37/.251	8.35/.329	8.86/.349	10.86/.428	12.87/.507	
POSITION	DIM G	MATERIAL NO	MATERIAL NO	MATERIAL NO	MATERIAL NO	MATERIAL NO	MATERIAL NO	MATERIAL NO	MATERIAL NO
10	17.69/0.698	45970-1115	45970-1215	45970-1315	45970-1415	45970-1515	45970-1615	45970-1715	45970-1915
20	30.39/1.198	45970-2115	45970-2215	45970-2315	45970-2415	45970-2515	45970-2615	45970-2715	45970-2915
30	43.09/1.698	45970-3115	45970-3215	45970-3315	45970-3415	45970-3515	45970-3615	45970-3715	45970-3915
40	55.79/2.198	45970-4115	45970-4215	45970-4315	45970-4415	45970-4515	45970-4615	45970-4715	45970-4915
50	68.49/2.698	45970-5115	45970-5215	45970-5315	45970-5415	45970-5515	45970-5615	45970-5715	45970-5915
15	24.04/0.948	45970-6115	45970-6215	45970-6315	45970-6415	45970-6515	45970-6615	45970-6715	45970-6915
25	36.74/1.448	45970-7115	45970-7215	45970-7315	45970-7415	45970-7515	45970-7615	45970-7715	45970-7915
35	49.44/1.948	45970-8115	45970-8215	45970-8315	45970-8415	45970-8515	45970-8615	45970-8715	45970-8915
45	62.14/2.448	45970-9115	45970-9215	45970-9315	45970-9415	45970-9515	45970-9615	45970-9715	45970-9915

SEE SHEET 1 EC NO: UCP2016-3194 DRAWN: TPROMO 2016/02/15 CHKD: PTEO 2016/02/16 APPR: DMCCOWAN 2016/02/16	QUALITY SYMBOLS	GENERAL TOLERANCES (UNLESS SPECIFIED)	DIMENSION STYLE	SCALE	DESIGN UNITS	THIRD ANGLE PROJECTION	
	$\nabla F/0$ $\nabla E/0$ $\nabla D/0$	mm INCH 4 PLACES ± --- ± --- 3 PLACES ± --- ± .010 2 PLACES ± 0.25 ± .015 1 PLACE ± 0.38 ± --- 0 PLACE ± ±	MM/IN	4:1	INCH	DRAWN BY DATE TGREGORI 2005/01/27 CHECKED BY DATE BBARKER 2014/08/07 APPROVED BY DATE JCOMERC I 2010/03/05	TITLE SEARAY PLUG ASSEMBLY 1.27/.050 CENTERS
	ANGULAR ± ---° DRAFT WHERE APPLICABLE MUST REMAIN WITHIN DIMENSIONS	MATERIAL NO.	DOCUMENT NO.	SHEET NO.			
	T2	9999999999	SD-45970-001	5 OF 5	THIS DRAWING CONTAINS INFORMATION THAT IS PROPRIETARY TO MOLEX INCORPORATED AND SHOULD NOT BE USED WITHOUT WRITTEN PERMISSION		

9 8 7 6 5 4 3 2 1