



FEATURES

1. High frequency characteristics (Impedance 50Ω)

| Frequency (GHz) | to 1 | 1 to 4 | 4 to 8 | 8 to 12.4 | 12.4 to 18 | 18 to 26.5* |
|---------------------------|------|--------|--------|-----------|------------|-------------|
| V.S.W.R. (max.) | 1.1 | 1.15 | 1.25 | 1.35 | 1.5 | 1.7 |
| Insertion loss (dB, max.) | 0.2 | | 0.3 | 0.4 | 0.5 | 0.8 |
| Isolation (dB, min.) | 85 | 80 | 70 | 65 | 60 | 55 |

* 18 to 26.5GHz characteristics can be applied 26.5GHz type only (SPDT, Transfer)

2. SPDT, Transfer and SP6T type is available

3. High sensitivity

Nominal operating power:
840 mW (SPDT/SP6T, Failsafe type)
1,540 mW (Transfer, Failsafe type)

4. Long life: 5×10^6

5. With termination type is available (SP6T)

6. + COM type is available

TYPICAL APPLICATIONS

Wireless and mobile communication

- Cellular phone base stations
- Amplifier switching

Digital broadcasting

- Broadcasting relay station
- Broadcasting equipment

Measurement instruments

- All types of inspection equipment

RoHS Directive compatibility information
<http://www.nais-e.com/>

SPECIFICATIONS

| Contact | | SPDT | Transfer | | | | |
|----------------------------------------------------------|------------------------------------------------------|-----------------------------------------------------------------------------------------------------------------------------|----------|--------|-----------|------------|--------------|
| Arrangement | | | | | | | |
| Contact material | | Gold | | | | | |
| Initial contact resistance (By voltage drop 6V DC 1A) | | Max. 100mΩ | | | | | |
| Rating | Contact input power*1 | 120W 3GHz (V.S.W.R. 1.15 or less, no contact switching, ambient temperature 40°C [SPDT], 25°C [Transfer], 25°C [SP6T])#1 | | | | | |
| Indicator rating | Contact rating | Max. 30V 100mA | | | | | |
| | Initial contact resistance (Measured by 5V 100mA) | Max. 1Ω | | | | | |
| High frequency characteristics (Impedance 50Ω) | | to 1GHz | 1 to 4 | 4 to 8 | 8 to 12.4 | 12.4 to 18 | 18 to 26.5#2 |
| | V.S.W.R. (max.) | 1.1 | 1.15 | 1.25 | 1.35 | 1.5 | 1.7 |
| | Insertion loss (dB, max.) | 0.2 | | 0.3 | 0.4 | 0.5 | 0.8 |
| | Isolation (dB, min.) | 85 | 80 | 70 | 65 | 60 | 55 |
| Expected life (min. operation) | Mechanical (at 180 cpm) | 5×10^6 | | | | | |
| | Electrical (at 20 cpm) | 5×10^6 (5W, to 3GHz, impedance 50Ω, V.S.W.R.; max. 1.2) | | | | | |

| | | | | | | |
|----------------------------------------------------------|------------------------------------------------------|-----------------------------------------------------------------------------------------------------------------------------|--------|--------|---------|--|
| Arrangement | | SP6T | | | | |
| Contact material | | Gold | | | | |
| Initial contact resistance (By voltage drop 6V DC 1A) | | Max. 100mΩ | | | | |
| Rating | Contact input power*1 | 120W 3GHz (V.S.W.R. 1.15 or less, no contact switching, ambient temperature 40°C [SPDT], 25°C [Transfer], 25°C [SP6T])#1 | | | | |
| Indicator rating | Contact rating | Max. 30V 100mA | | | | |
| | Initial contact resistance (Measured by 5V 100mA) | Max. 1Ω | | | | |
| High frequency characteristics (Impedance 50Ω) | | to 1GHz | 1 to 4 | 4 to 8 | 8 to 13 | |
| | V.S.W.R. (max.) | 1.1 | 1.15 | 1.25 | 1.35 | |
| | Insertion loss (dB, max.) | 0.2 | | 0.3 | 0.4 | |
| | Isolation (dB, min.) | 85 | 80 | 70 | 65 | |
| Expected life (min. operation) | Mechanical (at 180 cpm) | 5×10^6 | | | | |
| | Electrical (at 20 cpm) | 5×10^6 (5W, to 3GHz, impedance 50Ω, V.S.W.R.; max. 1.2) | | | | |

#1 Factors such as heating of the connected connector influence the high frequency characteristics; therefore, please verify under actual conditions of use.

#2 18 to 26.5 GHz characteristics apply to the 26.5 GHz type only.

Characteristics

| | | SPDT | Transfer |
|-------------------------------------------------------------------------------------------------------|------------------------------------|----------------------------------------|-------------|
| Initial insulation resistance*2 | | Min. 1,000 MΩ (at 500 V DC) | |
| Initial breakdown voltage*3 | Between open contacts | 500 Vrms for 1 min. | |
| | Between contact and coil | 500 Vrms for 1 min. | |
| | Between contact and earth terminal | 500 Vrms for 1 min. | |
| | Between coil and earth terminal | 500 Vrms for 1 min. | |
| Operate time*4 (at 20°C) | | Max. 15ms | Max. 20ms |
| Shock resistance | Functional*5 | Min. 500 m/s ² | |
| | Destructive*6 | Min. 1,000 m/s ² | |
| Vibration resistance | Functional*7 | 10 to 55 Hz at double amplitude of 3mm | |
| | Destructive | 10 to 55 Hz at double amplitude of 5mm | |
| Conditions for operation, transport and storage*8 (Not freezing and condensing at low temperature) | Ambient temp | -55°C to +85°C -67°F to +185°F | |
| | Humidity | 5 to 85% R.H. | |
| Unit weight (Approx.) | | 50g 1.76oz | 110g 3.88oz |

| | | SP6T |
|-------------------------------------------------------------------------------------------------------|------------------------------------|----------------------------------------|
| Initial insulation resistance*2 | | Min. 1,000 MΩ (at 500 V DC) |
| Initial breakdown voltage*3 | Between open contacts | 500 Vrms for 1 min. |
| | Between contact and coil | 500 Vrms for 1 min. |
| | Between contact and earth terminal | 500 Vrms for 1 min. |
| | Between coil and earth terminal | 500 Vrms for 1 min. |
| Operate time*4 (at 20°C) | | Max. 20ms |
| Shock resistance | Functional*5 | Min. 500 m/s ² |
| | Destructive*6 | Min. 1,000 m/s ² |
| Vibration resistance | Functional*7 | 10 to 55 Hz at double amplitude of 3mm |
| | Destructive | 10 to 55 Hz at double amplitude of 5mm |
| Conditions for operation, transport and storage*8 (Not freezing and condensing at low temperature) | Ambient temp | -55°C to +85°C -67°F to +185°F |
| | Humidity | 5 to 85% R.H. |
| Unit weight (Approx.) | | 320g 11.29oz |

Remarks

*1 Please verify the usability of input power under actual conditions because heat generated from connectors can influence connection.

*2 Measurement at same location as "Initial breakdown voltage" section.

*3 Detection current: 10mA

*4 Nominal operating voltage applied to the coil, excluding contact bounce time.

*5 Half-wave pulse of sine wave: 11ms, detection time: 10ms.

*6 Half-wave pulse of sine wave: 11ms

*7 Detection time: 10ms

*8 Refer to 4. Conditions for operation, transport and storage conditions in NOTES (Page 42).

ORDERING INFORMATION

Ex. A RD

| Product name | Frequency | Operating function | Nominal operating voltage, V DC | Operation terminal | HF data attached |
|--------------|------------------------------------------------------------------------------------------------------------------------|------------------------------------------------------------------------------------------------------------------|----------------------------------------------------------------------------------------------------------------|----------------------------------------------------------------|--------------------------------------------------------------|
| RD | 1: to 18GHz (SPDT) 2: to 18GHz (Transfer) 3: to 13GHz (SP6T) 5: to 26.5GHz (SPDT) 6: to 26.5GHz (Transfer) | 00: Failsafe 20: Latching 51: Latching with TTL driver (with self cut-off function) (SPDT, Transfer) | 4H: 4.5 (Failsafe, Latching type only) 05: 5 (Latching with TTL driver type only) 12: 12 24: 24 | Nil: Solder terminal C: Connector cable (SPDT type only) | Nil: No HF test data attached Q: HF test data attached |

Note: Sealed types are also available. (SPDT type only)

RD (ARD)

TYPES

1. SPDT

1) Solder terminal

| Operating function | Nominal operating voltage, V DC | 18GHz type | | 26.5GHz type | |
|-------------------------------------------------------|---------------------------------|--------------------------|-----------------------|--------------------------|-----------------------|
| | | No HF datasheet attached | HF datasheet attached | No HF datasheet attached | HF datasheet attached |
| Failsafe | 4.5 | ARD1004H | ARD1004HQ | ARD5004H | ARD5004HQ |
| | 12 | ARD10012 | ARD10012Q | ARD50012 | ARD50012Q |
| | 24 | ARD10024 | ARD10024Q | ARD50024 | ARD50024Q |
| Latching | 4.5 | ARD1204H | ARD1204HQ | ARD5204H | ARD5204HQ |
| | 12 | ARD12012 | ARD12012Q | ARD52012 | ARD52012Q |
| | 24 | ARD12024 | ARD12024Q | ARD52024 | ARD52024Q |
| Latching with TTL driver (with self cut-off function) | 5 | ARD15105 | ARD15105Q | ARD55105 | ARD55105Q |
| | 12 | ARD15112 | ARD15112Q | ARD55112 | ARD55112Q |
| | 24 | ARD15124 | ARD15124Q | ARD55124 | ARD55124Q |

Note: Standard packing; Carton: 1 pc. Case: 20 pcs.

2) Connector cable

| Operating function | Nominal operating voltage, V DC | 18GHz type | | 26.5GHz type | |
|-------------------------------------------------------|---------------------------------|--------------------------|-----------------------|--------------------------|-----------------------|
| | | No HF datasheet attached | HF datasheet attached | No HF datasheet attached | HF datasheet attached |
| Failsafe | 4.5 | ARD1004HC | ARD1004HCQ | ARD5004HC | ARD5004HCQ |
| | 12 | ARD10012C | ARD10012CQ | ARD50012C | ARD50012CQ |
| | 24 | ARD10024C | ARD10024CQ | ARD50024C | ARD50024CQ |
| Latching | 4.5 | ARD1204HC | ARD1204HCQ | ARD5204HC | ARD5204HCQ |
| | 12 | ARD12012C | ARD12012CQ | ARD52012C | ARD52012CQ |
| | 24 | ARD12024C | ARD12024CQ | ARD52024C | ARD52024CQ |
| Latching with TTL driver (with self cut-off function) | 5 | ARD15105C | ARD15105CQ | ARD55105C | ARD55105CQ |
| | 12 | ARD15112C | ARD15112CQ | ARD55112C | ARD55112CQ |
| | 24 | ARD15124C | ARD15124CQ | ARD55124C | ARD55124CQ |

Note: Standard packing; Carton: 1 pc. Case: 10 pcs.

2. Transfer

1) Solder terminal

| Operating function | Nominal operating voltage, V DC | 18GHz type | | 26.5GHz type | |
|-------------------------------------------------------|---------------------------------|--------------------------|-----------------------|--------------------------|-----------------------|
| | | No HF datasheet attached | HF datasheet attached | No HF datasheet attached | HF datasheet attached |
| Failsafe | 4.5 | ARD2004H | ARD2004HQ | ARD6004H | ARD6004HQ |
| | 12 | ARD20012 | ARD20012Q | ARD60012 | ARD60012Q |
| | 24 | ARD20024 | ARD20024Q | ARD60024 | ARD60024Q |
| Latching | 4.5 | ARD2204H | ARD2204HQ | ARD6204H | ARD6204HQ |
| | 12 | ARD22012 | ARD22012Q | ARD62012 | ARD62012Q |
| | 24 | ARD22024 | ARD22024Q | ARD62024 | ARD62024Q |
| Latching with TTL driver (with self cut-off function) | 5 | ARD25105 | ARD25105Q | ARD65105 | ARD65105Q |
| | 12 | ARD25112 | ARD25112Q | ARD65112 | ARD65112Q |
| | 24 | ARD25124 | ARD25124Q | ARD65124 | ARD65124Q |

Note: Standard packing; Carton: 1 pc. Case: 10 pcs.

3. SP6T

| Operating function | Nominal operating voltage, V DC | 13GHz type | |
|--------------------|---------------------------------|--------------------------|-----------------------|
| | | No HF datasheet attached | HF datasheet attached |
| Failsafe | 4.5 | ARD3004H | ARD3004HQ |
| | 12 | ARD30012 | ARD30012Q |
| | 24 | ARD30024 | ARD30024Q |
| Latching | 4.5 | ARD3204H | ARD3204HQ |
| | 12 | ARD32012 | ARD32012Q |
| | 24 | ARD32024 | ARD32024Q |

Note: Standard packing; Carton: 1 pc. Case: 5 pcs.

COIL DATA (at 20°C 68°F)**1. SPDT**

1) Failsafe type

| Nominal operating voltage, V DC | Nominal operating current, mA (+10%/–15%) | Nominal power consumption, mW |
|------------------------------------|----------------------------------------------|-------------------------------|
| 4.5 | 186.7 | 840 |
| 12 | 70.0 | 840 |
| 24 | 40.4 | 970 |

2) Latching type

| Nominal operating voltage, V DC | Nominal operating current, mA (+10%/–15%) | Nominal power consumption, mW |
|------------------------------------|----------------------------------------------|-------------------------------|
| 4.5 | 155.6 | 700 |
| 12 | 62.5 | 750 |
| 24 | 37.5 | 900 |

3) Latching with TTL driver type (with self cut-off function)

| Nominal operating voltage, V DC | TTL logic level (see TTL logic level range) | | Switching frequency |
|------------------------------------|---------------------------------------------|-----------|----------------------------------------------|
| | ON | OFF | |
| 5 | 2.4 to 5.5V | 0 to 0.5V | Max. 180 cpm (ON time : OFF time = 1 : 1) |
| 12 | | | |
| 24 | | | |

2. Transfer

1) Failsafe type

| Nominal operating voltage, V DC | Nominal operating current, mA (+10%/–15%) | Nominal power consumption, mW |
|------------------------------------|----------------------------------------------|-------------------------------|
| 4.5 | 342.2 | 1540 |
| 12 | 128.3 | 1540 |
| 24 | 69.6 | 1670 |

2) Latching type

| Nominal operating voltage, V DC | Nominal operating current, mA (+10%/–15%) | Nominal power consumption, mW |
|------------------------------------|----------------------------------------------|-------------------------------|
| 4.5 | 266.7 | 1200 |
| 12 | 104.2 | 1250 |
| 24 | 58.3 | 1400 |

3) Latching with TTL driver type (with self cut-off function)

| Nominal operating voltage, V DC | TTL logic level (see TTL logic level range) | | Switching frequency |
|------------------------------------|---------------------------------------------|-----------|----------------------------------------------|
| | ON | OFF | |
| 5 | 2.4 to 5.5V | 0 to 0.5V | Max. 180 cpm (ON time : OFF time = 1 : 1) |
| 12 | | | |
| 24 | | | |

3. SP6T

1) Failsafe type

| Nominal operating voltage, V DC | Nominal operating current, mA (+10%/–15%) | Nominal power consumption, mW |
|------------------------------------|----------------------------------------------|-------------------------------|
| 4.5 | 186.7 | 840 |
| 12 | 70.0 | 840 |
| 24 | 40.4 | 970 |

2) Latching type

| Nominal operating voltage, V DC | Nominal operating current, mA (+10%/–15%) | Nominal power consumption, mW |
|------------------------------------|----------------------------------------------|-------------------------------|
| 4.5 | SET: 155.6 / RESET (ALL): 933.6 | SET: 700 / RESET (ALL): 4,200 |
| 12 | SET: 62.5 / RESET (ALL): 375.0 | SET: 750 / RESET (ALL): 4,500 |
| 24 | SET: 37.5 / RESET (ALL): 225.0 | SET: 900 / RESET (ALL): 5,400 |

RD (ARD)

• Operating voltage range

1) Failsafe type

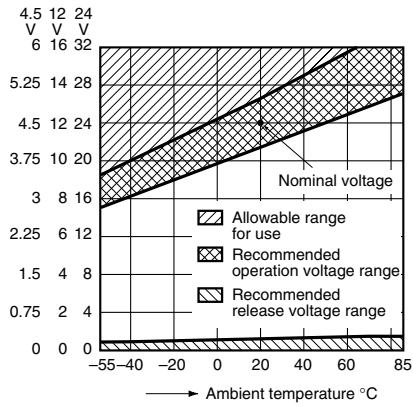

2) Latching type

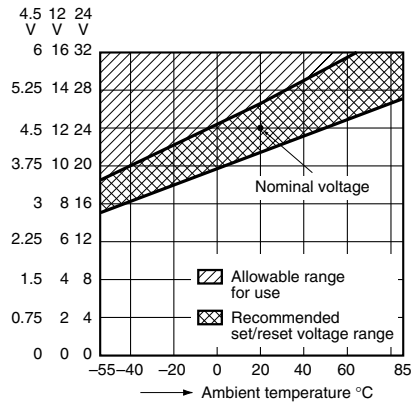

3) Latching with TTL driver type (with self cut-off function)

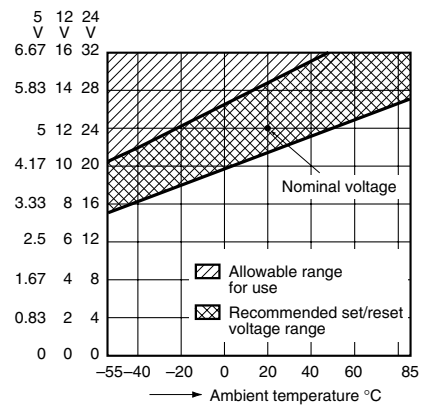

4) TTL Logic level range

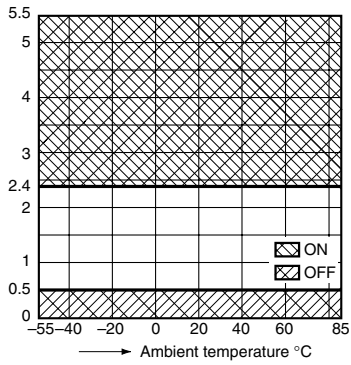

Note) Please consult us for use that is outside this range.

DIMENSIONS

1. SPDT

1) Solder terminal

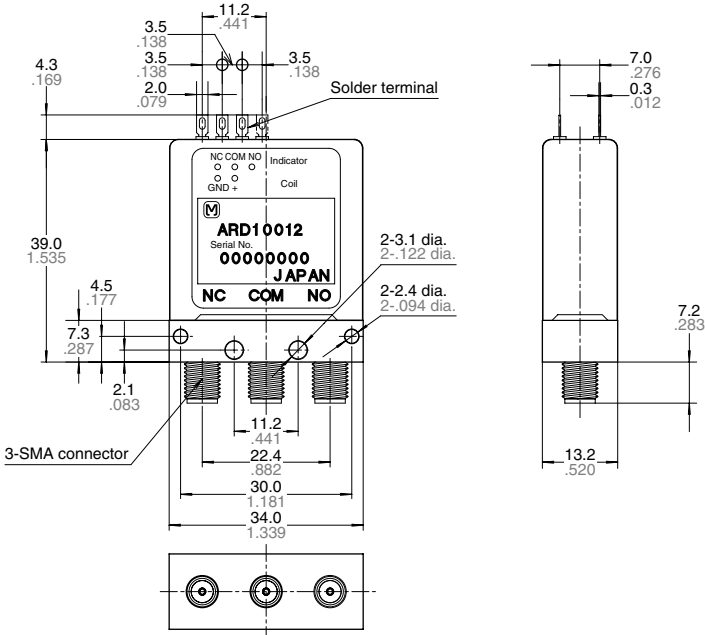

Tolerance: ±0.3 ±0.012

Failsafe

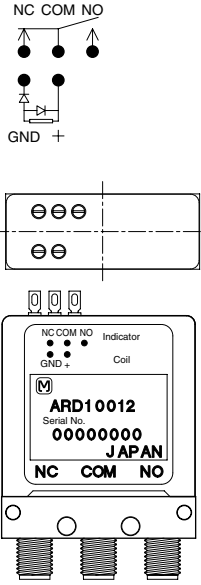

Latching

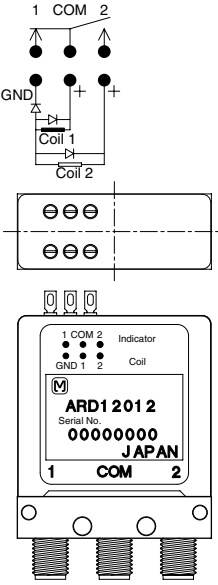

Latching with TTL driver (with self cut-off function)

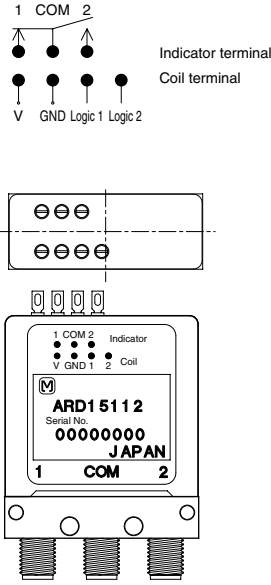

* + COM type is available

RD (ARD)

2) Connector cable

mm inch



| Pin No. | Indicator | | | | | Coil | | | |
|--------------------------|-----------|----|-----|----|---|------|-----|---------|---------|
| | ① | ② | ③ | ④ | ⑤ | ⑥ | ⑦ | ⑧ | ⑨ |
| Fail safe | - | NC | COM | NO | - | - | GND | + | - |
| Latching | - | 1 | COM | 2 | - | - | GND | 1 | 2 |
| Latching with TTL driver | - | 1 | COM | 2 | - | V | GND | Logic 1 | Logic 2 |

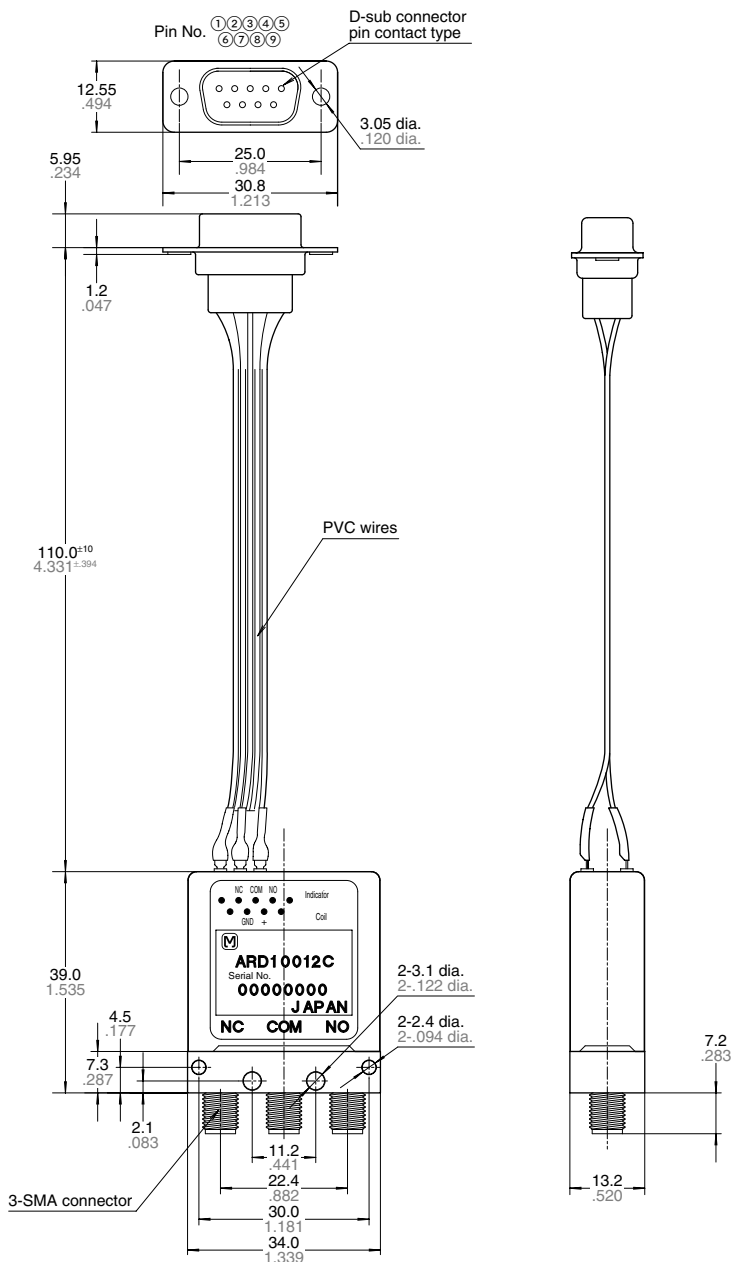

Tolerance: $\pm 0.3 \pm 0.12$

Failsafe

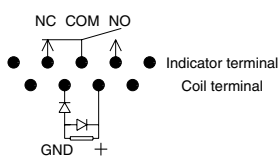

Latching

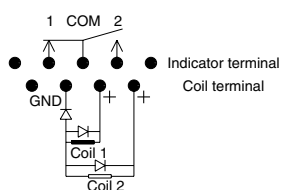

Latching with TTL driver
(with self cut-off function)

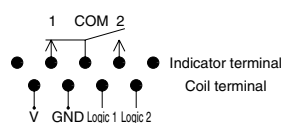

* + COM type is available

2. Transfer

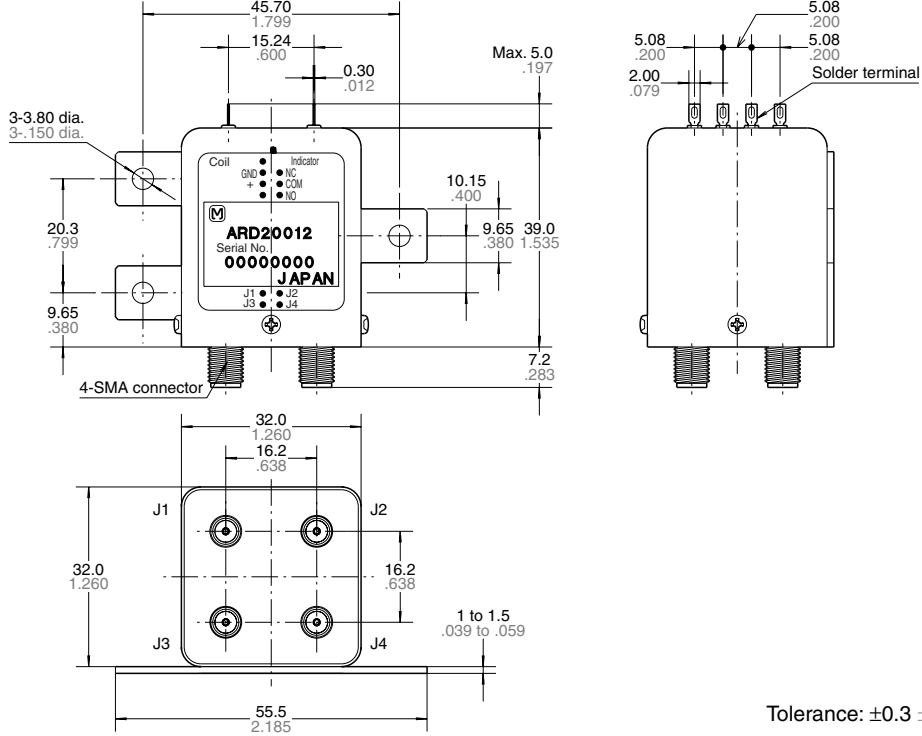

Tolerance: $\pm 0.3 \pm 0.12$

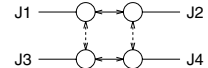

| | |
|--------------------------|------------------------------------------|
| Fail safe | NC: J1-J2, J3-J4 NO: J1-J3, J2-J4 |
| Latching | POS1: J1-J2, J3-J4 POS2: J1-J3, J2-J4 |
| Latching with TTL driver | POS1: J1-J2, J3-J4 POS2: J1-J3, J2-J4 |

Failsafe

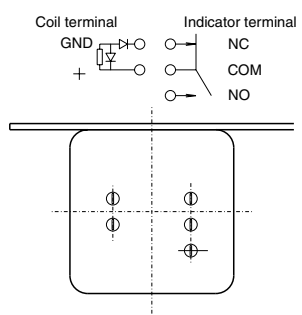

Latching

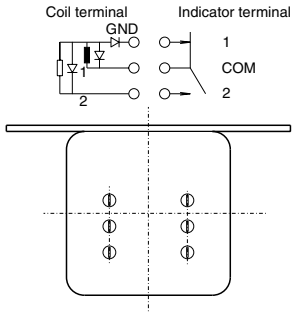

Latching with TTL driver (with self cut-off function)

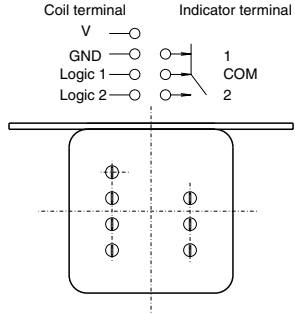

* + COM type is available

RD (ARD)

3. SP6T

mm inch

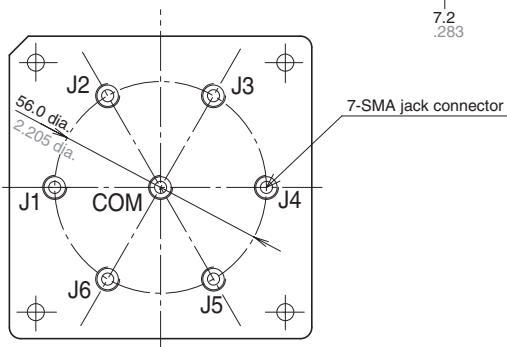
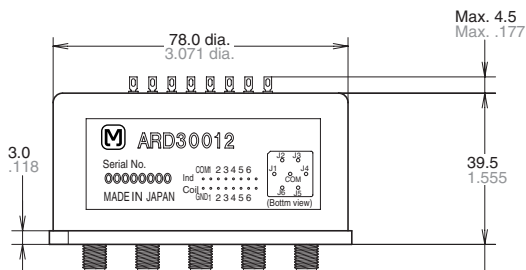
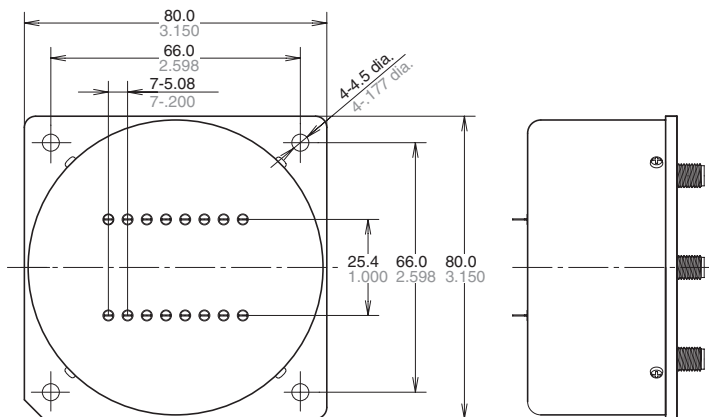
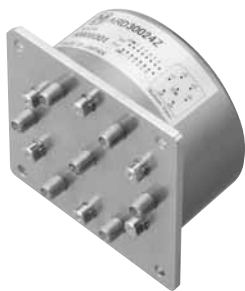

Failsafe type

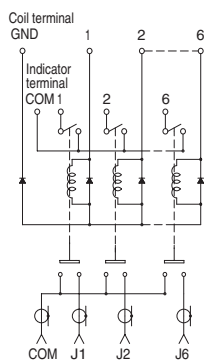

Latching type

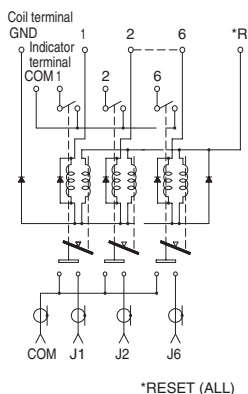

* 1. With termination type is available.
2. + COM type is available.

REFERENCE DATA

1-(1). High frequency characteristics (SPDT)

Sample: ARD10012

Measuring method: Measured with HP network analyzer (HP8510).

• V.S.W.R.

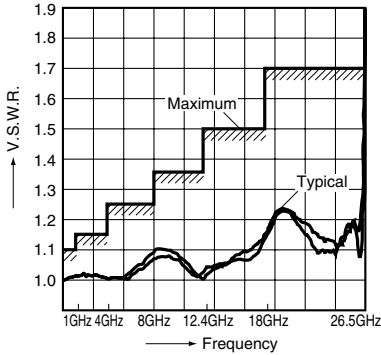

• Insertion loss

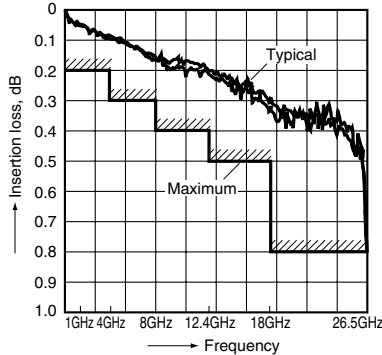

• Isolation

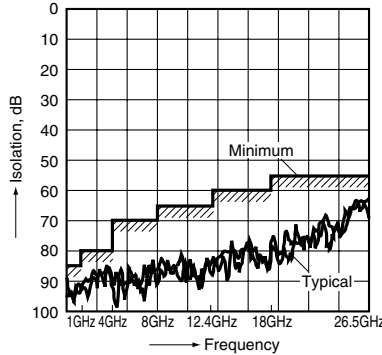

1-(2). High frequency characteristics (Transfer)

Sample: ARD60012

Measuring method: Measured with HP network analyzer (HP8510).

• V.S.W.R.

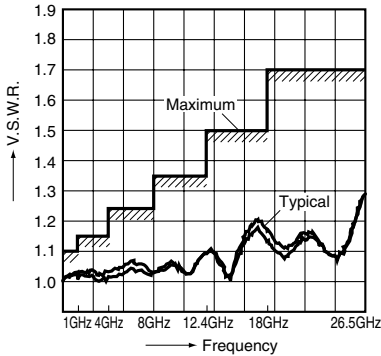

• Insertion loss

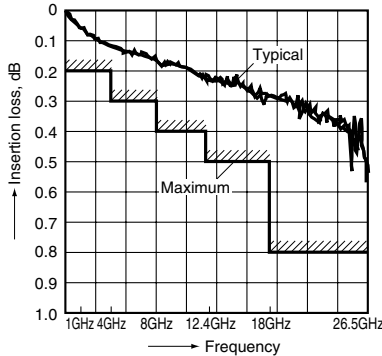

• Isolation

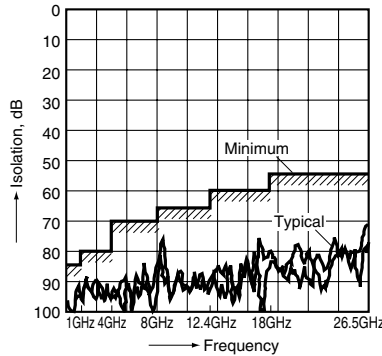

1-(3). High frequency characteristics (SP6T)

Measuring method: Measured with HP network analyzer (HP8510).

• V.S.W.R.

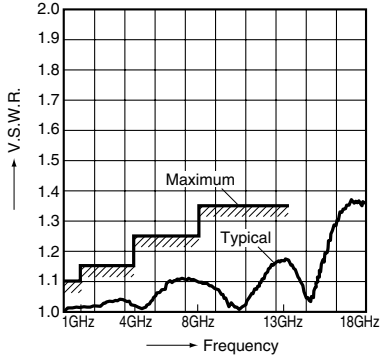

• Insertion loss

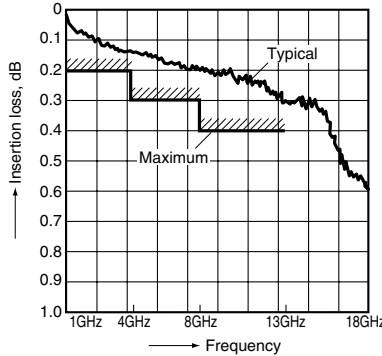

• Isolation

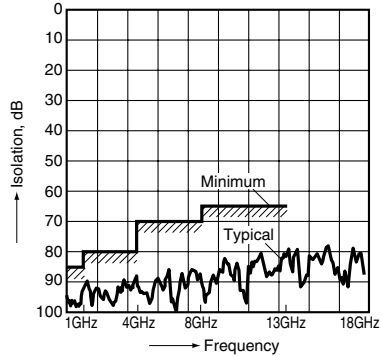

RD (ARD)

NOTES

1. Coil operating power

Pure DC current should be applied to the coil. The wave form should be rectangular. If it includes ripple, the ripple factor should be less than 5%.

However, check it with the actual circuit since the characteristics may be slightly different. The nominal operating voltage should be applied to the coil for more than 50 ms to set/reset the latching type relay.

Please use the latching type for circuits that are continually powered for long periods of time.

2. Coil connection

When connecting coils, refer to the wiring diagram to prevent mis-operation or malfunction.

3. Connection of coil indicator and washing conditions

1) The connection of coil indicator terminal shall be done by soldering.

Soldering conditions

Max. 260°C 500°F (solder temp) within 10sec (soldering time)

Max. 350°C 662°F (solder temp) within 3sec (soldering time)

2) This product is not sealed type, therefore washing is not allowed.

4. Conditions for operation, transport and storage conditions

1) Ambient temperature, humidity, and atmospheric pressure during usage, transport, and storage of the relay:

(1) Temperature:

-55 to +85°C -67 to +185°F

(2) Humidity: 5 to 85% RH

(Avoid freezing and condensation.)

The humidity range varies with the temperature. Use within the range indicated in the graph below.

(3) Atmospheric pressure: 86 to 106 kPa

Temperature and humidity range for usage, transport, and storage:

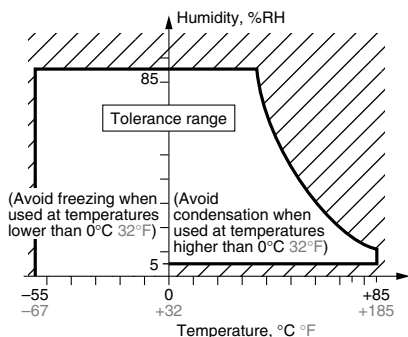

2) Condensation

Condensation forms when there is a sudden change in temperature under high temperature and high humidity conditions. Condensation will cause deterioration of the relay insulation.

3) Freezing

Condensation or other moisture may freeze on the relay when the temperature is lower than 0°C 32°F. This causes problems such as sticking of movable parts or operational time lags.

4) Low temperature, low humidity environments.

The plastic becomes brittle if the relay is exposed to a low temperature, low humidity environment for long periods of time.

5) Low-temperature and low-humidity atmosphere.

When exposed to low temperature and low humidity for a long time, the relay's plastic casing may become breakable.

5. Other handling precautions.

1) The relay's on/off service life is based on standard test conditions (temperature: 15 to 35°C 59 to 95°F, humidity: 25 to 75%) specified in JIS C5442-1996. Life will depend on many factors of your system: coil drive circuit, type of load, switching intervals, switching phase, ambient conditions, to name a few.

2) Use the relay within specifications such as coil rating, contact rating and on/off service life. If used beyond limits, the relay may overheat, generate smoke or catch fire.

3) Be careful not to drop the relay. If accidentally dropped, carefully check its appearance and characteristics before use.

4) Be careful to wire the relay correctly. Otherwise, malfunction, overheat, fire or other trouble may occur.

5) The latching type relay is shipped in the reset position. But jolts during transport or impacts during installation can move it to the set position. It is, therefore, advisable to build a circuit in which the relay can be initialized (set and reset) just after turning on the power.

6) If a relay stays on in a circuit for many months or years at a time without being activated, circuit design should be reviewed so that the relay can remain non-excited. A coil that receives current all the time heats, which degrades insulation earlier than expected. A latching type relay is recommended for such circuits.

7) For SMA connectors, we recommend a torque of 0.90±0.1 N·m for installation, which falls within the prescribed torque of MIL-C-39012. Please be aware that conditions might be different depending on the connector materials and how it interacts with surrounding materials.

8) Please do not use silicon based substances such as silicon rubber, silicon oil, silicon coatings and silicon fillings, in the vicinity of the relay. Doing so may cause volatile silicon gas to form which may lead to contact failure due to the adherence of silicon on the contacts when they open and close in this atmosphere.

9) Please note that when switching contacts (latching type only), you must apply reset (ALL) voltage and release all contacts first. (SP6T type)

10) Do not use multiple contacts simultaneously. (SP6T type)