

Powerex, Inc., 173 Pavilion Lane, Youngwood, Pennsylvania 15697 (724) 925-7272
www.pwr.com

POW-R-BLOK™ Dual SCR Isolated Module 250 Amperes / Up to 1600 Volts

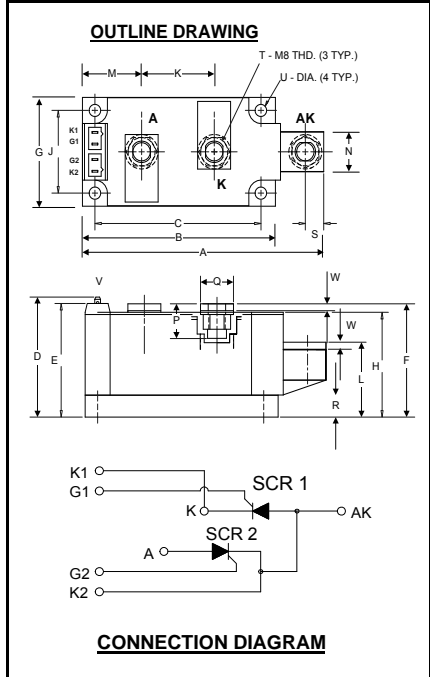

ND43__25
Dual SCR Isolated
POW-R-BLOK™ Module
250 Amperes / Up to 1600 Volts

Description:

Powerex Dual SCR Modules are designed for use in applications requiring phase control and isolated packaging. The modules are isolated for easy mounting with other components on a common heatsink. POW-R-BLOK™ has been tested and recognized by the Underwriters Laboratories.

Features:

- Electrically Isolated Heatsinking
- Aluminum Nitride Insulator
- Compression Bonded Elements
- Metal Baseplate
- Low Thermal Impedance for Improved Current Capability
- Quick Connect Gate Terminal with Provision for Keyed Mating Plug
- UL Recognized

ND43 Outline Dimensions

| Dimension | Inches | Millimeters |
|-----------|-------------|-------------|
| A | 4.57 | 116 |
| B | 3.66 | 93 |
| C | 3.15 | 80.0 |
| D | 2.17 | 55.1 |
| E | 2.06 | 52.3 |
| F | 2.07 | 52.0 |
| G | 1.97 | 50.0 |
| H | 1.90 | 48.3 |
| J | 1.50 | 38.1 |
| K | 1.38 | 35.0 |
| L | 1.26 | 32.0 |
| M | 1.122 | 28.5 |
| N | .71 | 18.0 |
| P | .57 | 14.5 |
| Q | .625 | 15.9 |
| R | .394 | 10.00 |
| S | .350 | 8.9 |
| T | M8 Metric | M8 |
| U | .250 Dia. | 6.35 Dia. |
| V | .110 x .032 | 2.8 x 0.8 |
| W | .12 | 3.0 |

Note: Dimensions are for reference only.

Ordering Information:

Select the complete eight digit module part number from the table below.

Example: ND431625 is a 1600Volt, 250 Ampere Dual SCR Isolated POW-R-BLOK™ Module

| Type | Voltage Volts (x100) | Current Amperes (x 10) |
|------|----------------------------------|------------------------------|
| ND43 | 06 08 10 12 14 16 | 25 |

Benefits:

- No Additional Insulation Components Required
- Easy Installation
- No Clamping Components Required
- Reduce Engineering Time

Applications:

- Bridge Circuits
- AC & DC Motor Drives
- Battery Supplies
- Power Supplies
- Large IGBT Circuit Front Ends

Absolute Maximum Ratings

| Characteristics | Conditions | Symbol | | Units |
|-----------------------------------------------------------------|---------------------------------------------------------------------------------------------------------------------------------------------------------------|-----------------------|-------------|------------------------|
| Repetitive Peak Forward and Reverse Blocking Voltage | | V_{DRM} & V_{RRM} | up to 1600 | V |
| Non-Repetitive Peak Reverse Blocking Voltage ($t < 5$ msec) | | V_{RSM} | 1600 | V |
| RMS Forward Current | 180° Conduction, $T_C=89^\circ\text{C}$ | $I_{T(RMS)}$ | 393 | A |
| Average Forward Current | 180° Conduction, $T_C=89^\circ\text{C}$ | $I_{T(AV)}$ | 250 | A |
| Peak One Cycle Surge Current, Non-Repetitive | 60 Hz, 100% V_{RRM} reapplied | I_{TSM} | 8800 | A |
| Peak Three Cycle Surge Current, Non-Repetitive | 60 Hz, 100% V_{RRM} reapplied | I_{TSM} | 4685 | A |
| Peak Ten Cycle Surge Current, Non-Repetitive | 60 Hz, 100% V_{RRM} reapplied | I_{TSM} | 4040 | A |
| I^2t for Fusing for One Cycle, 8.3 milliseconds | | I^2t | 322,000 | A^2sec |
| Maximum Rate-of-Rise of On-State Current, (Non-Repetitive) | $T_j=25^\circ\text{C}$, $I_G=500\text{mA}$, $V_D=0.67 V_{DRM}(\text{Rated})$, $I_{TM}=\pi I_{T(AV)}$, $T_r < 0.5\mu\text{s}$, $t_p > 6\mu\text{s}$ | di/dt | 800 | $\text{A}/\mu\text{s}$ |
| Peak Gate Power Dissipation | | P_{GM} | 16 | W |
| Average Gate Power Dissipation | | $P_{G(AV)}$ | 3 | W |
| Peak Forward Gate Current | | I_{GFM} | 4 | A |
| Peak Forward Gate Voltage | | V_{GFM} | 10 | V |
| Peak Reverse Gate Voltage | | V_{GRM} | 5 | V |
| Operating Temperature | | T_J | -40 to +130 | $^\circ\text{C}$ |
| Storage Temperature | | T_{stg} | -40 to +150 | $^\circ\text{C}$ |
| Max. Mounting Torque, M6 Mounting Screw | | | 45 5 | in.-Lb. Nm |
| Max. Mounting Torque, M8 Terminal Screw | | | 110 12 | in.-Lb. Nm |
| Module Weight, Typical | | | 840 1.85 | g lb |
| V Isolation @ 25C | | V_{rms} | 2500 | V |

Electrical Characteristics, T_J=25°C unless otherwise specified

| Characteristics | Symbol | Test Conditions | Min. | Max. | Units |
|------------------------------------------|--------------------|--------------------------------------------------------------------------------------------------------------|------|-----------|-------|
| Repetitive Peak Forward Leakage Current | I _{DRM} | Up to 1600V, T _J =130°C | | 50 | mA |
| Repetitive Peak Reverse Leakage Current | I _{RDM} | Up to 1600V, T _J =130°C | | 50 | mA |
| Peak On-State Voltage | V _{FM} | I _{TM} =625A | | 1.30 | V |
| Threshold Voltage, Low-level | V _{(TO)1} | T _J = 130°C, I = 15%I _{T(AV)} to π I _{T(AV)} | | 0.819 | V |
| Slope Resistance, Low-level | r _{T1} | | | 0.589 | mΩ |
| Threshold Voltage, High-level | V _{(TO)2} | T _J = 130°C, I = π I _{T(AV)} to I _{TSM} | | 0.47 | V |
| Slope Resistance, High-level | r _{T2} | | | 0.731 | mΩ |
| V _{TM} Coefficients, Full Range | | T _J = 130°C, I = 15%I _{T(AV)} to I _{TSM} | A = | 0.5849 | |
| | | | B = | 0.1060 | |
| | | V _{TM} = A + B Ln I + C I + D Sqrt I | C = | 9.25 E-4 | |
| | | | D = | -0.0286 | |
| Minimum dV/dt | dV/dt | Exponential to 2/3 V _{DRM} T _J =130°C, Gate Open | 500 | | V/μs |
| Turn-On Time (Typical) | t _{on} | I _{TM} = 100A, V _D = 100V | 7 | (Typical) | μs |
| Turn-Off Time (Typical) | t _{off} | T _J = 130°C, I _T = 250A Re-Applied dV/dt = 20V/μs Linear to 0.8 V _{DRM} | 150 | (Typical) | μs |
| Gate Trigger Current | I _{GT} | T _J =25°C, V _D =12V | | 150 | mA |
| Gate Trigger Voltage | V _{GT} | T _J =25°C, V _D =12V | | 3.0 | Volts |
| Non-Triggering Gate Voltage | V _{GDM} | T _J =130°C, V _D = 1/2 V _{DRM} | | 0.15 | Volts |

Thermal Characteristics

| Characteristics | Symbol | | Max. | Units |
|---------------------------------------------|-------------------|----------------------------------------------------------------------------------------------------------------------------------------------------------------------------------------------------------------|--------------------------------------------------------------------------------------------------------------|-----------------------------------------------------------------------------------------------------------|
| Thermal Resistance, Junction to Case | R _{ΘJ-C} | Per Module, both conducting Per Junction both conducting | 0.07 0.14 | °C/W °C/W |
| Thermal Impedance Coefficients | Z _{ΘJ-C} | Z _{ΘJ-C} = K ₁ (1-exp(-t/τ ₁)) + K ₂ (1-exp(-t/τ ₂)) + K ₃ (1-exp(-t/τ ₃)) + K ₄ (1-exp(-t/τ ₄)) | K ₁ = 5.27E-3 K ₂ = 1.17E-2 K ₃ = 5.26E-2 K ₄ = 6.97E-2 | τ ₁ = 1.69E-4 τ ₂ = 2.07E-2 τ ₃ = 2.37E-1 τ ₄ = 2.46 |
| Thermal Resistance, Case to Sink Lubricated | R _{ΘC-S} | Per Module | 0.03 | °C/W |

Maximum On-State Forward Voltage Drop

($T_j = 130^\circ\text{C}$)

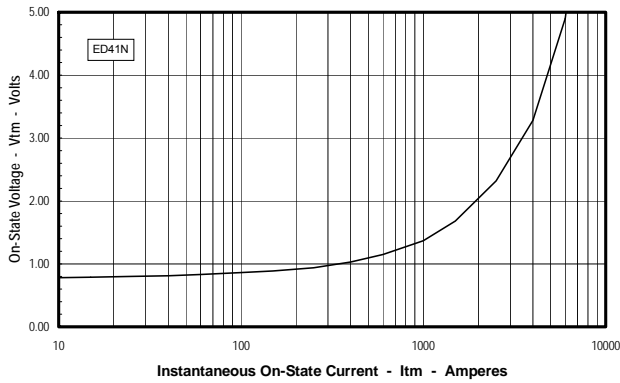

Maximum Transient Thermal Impedance

(Junction to Case, Per SCR)

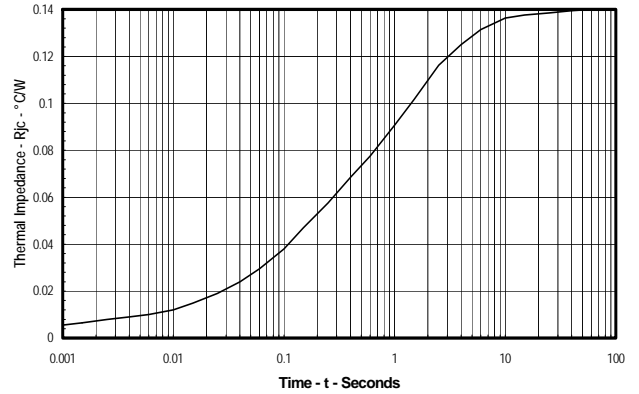

Maximum On-State Power Dissipation

(Sinusoidal Waveform)

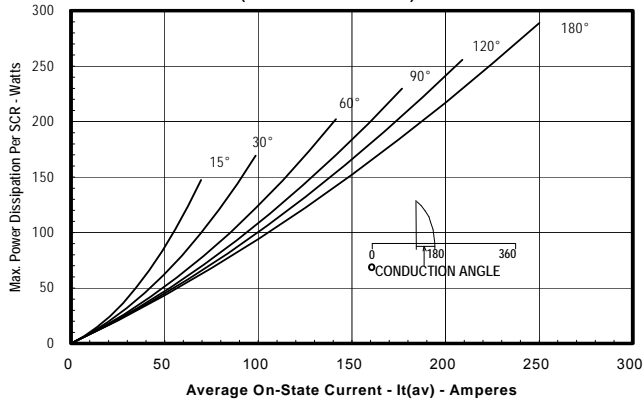

Maximum Allowable Case Temperature

(Sinusoidal Waveform)

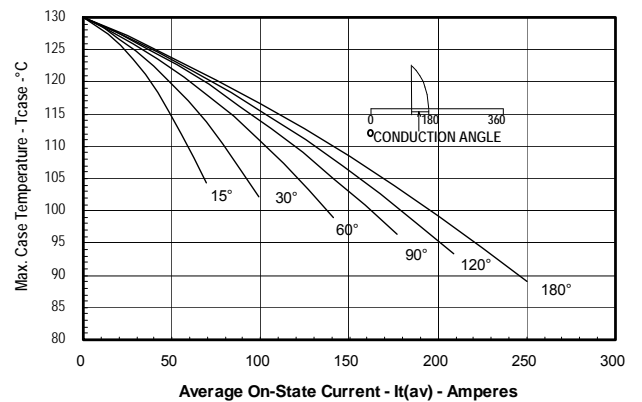

Maximum On-State Power Dissipation

(Rectangular Waveform)

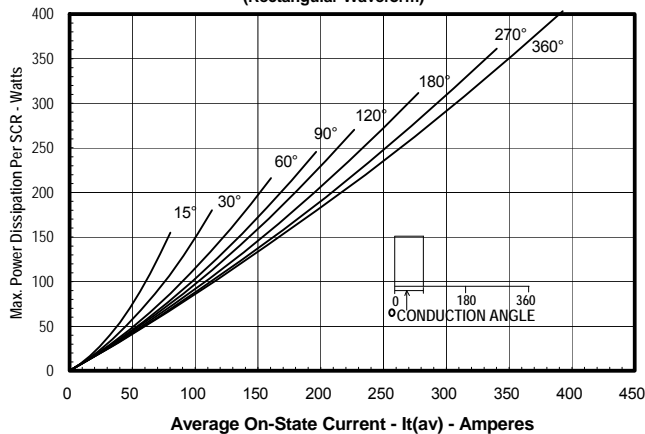

Maximum Allowable Case Temperature

(Rectangular Waveform)

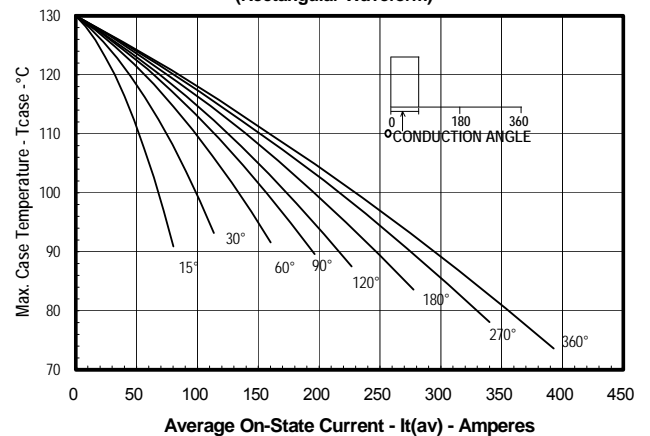

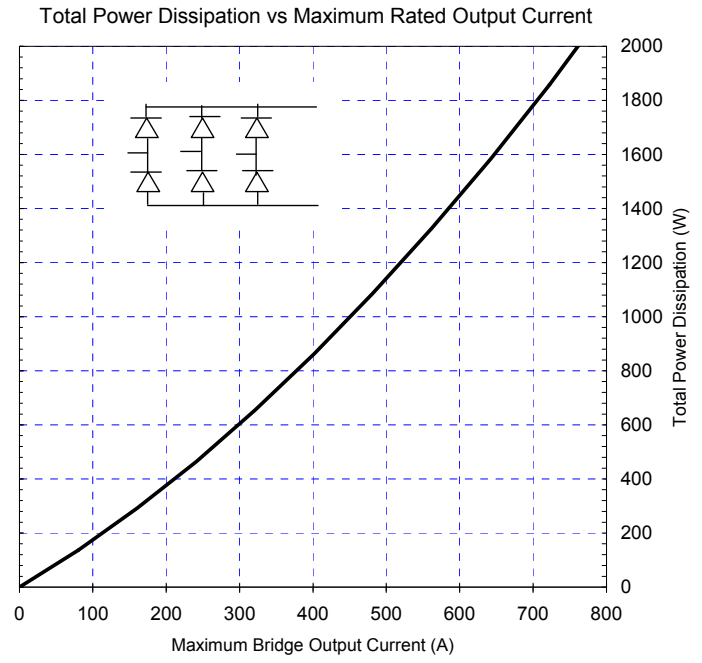
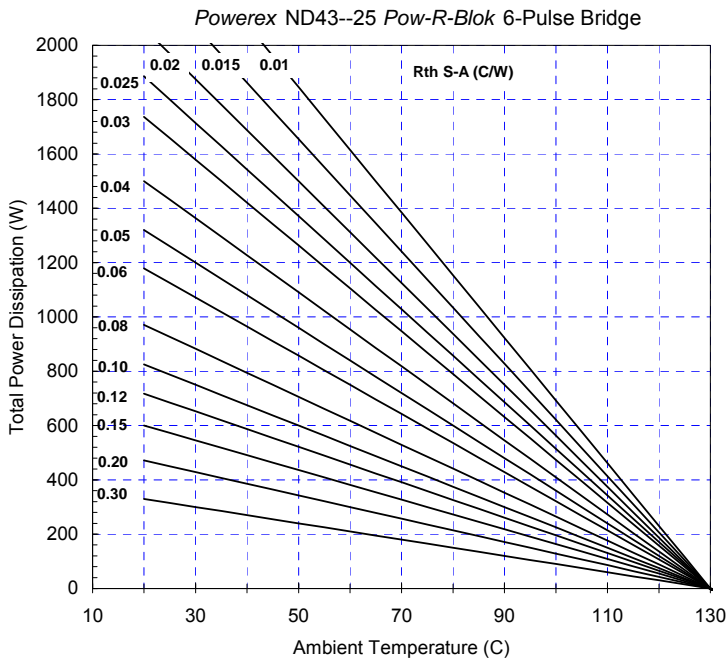

Six-Pulse Bridge Circuit Total Power Dissipation & Maximum Rated Output Current With Sink to Ambient Resistance of Heatsink as a Parameter.