

5

4

3

2

1

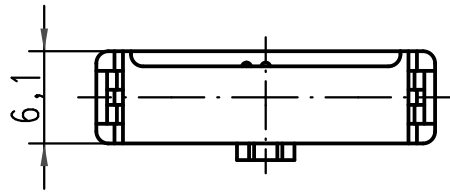
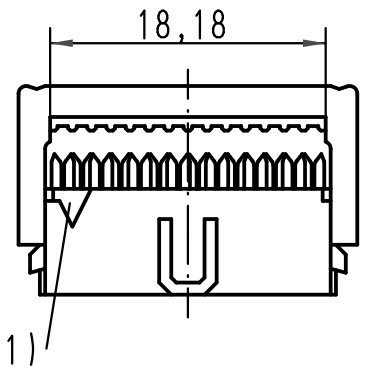
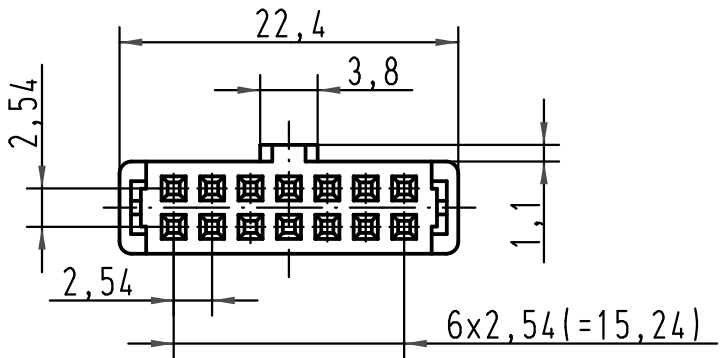

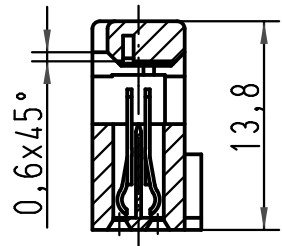

vorverrastet
pre assembled
preassemble

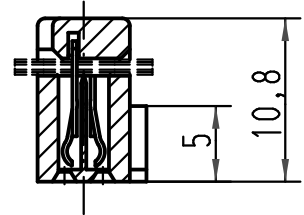

verrastet
fitted
assemble

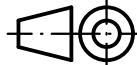

1) Markierung erster Kontakt, Ader 1 des Flachkabels
1) Contact no.1, 1st contact wire of flat cable
1) Contact no.1, repère 1 du câble

A	0918 514 5803 58U	0,76 μm Au	Bulk packaging MOQ = 5000 pcs	 All Dimensions in mm Original Size DIN A 4			Techn. Character.			Nicht tolerierte Masse/ Free size tolerances					
	0918 514 6803 58U	2					Detail.			Date			SEK 18 Female Connector 14 poles with central polarisation cover without cable stop		
	0918 514 7803 58U	3					Insp.			Name					
	0918 514 5803	0,76 μm Au	Stand.			Th									
	0918 514 6803	2	N.A.	33788			24/07/06			PK					
	0918 514 7803	3	N.A.	26570			01-FEB-00			JB					
Bestell-Nr. Part-No. Reference		Anforderungsstufe Performance level Niveau de qualite	Index Designation		Mod.		Dat.		Name		HARTING EURL F-95972 Paris 		TB 09 18 514 X803 Sub.		Blatt/ page 1 / 1