

NOTES:

1. MATERIAL HOUSING: GLASS FILLED LCP (LIQUID CRYSTAL POLYMER), 94V-0, COLOR-BLACK. CONTACT: COPPER ALLOY.
2. FINISH: SELECT GOLD - .76 MICROMETERS/30 MICRONS MINIMUM CONTACT AREA. SELECT TIN - 3.81 MICROMETERS/150 MICRONS MINIMUM TAIL AREA. BOTH OVER NICKEL - 1.27 MICROMETERS/50 MICRONS MINIMUM.
3. POWER TERMINALS ARE LUBRICATED IN CONTACT AREA.
3. PRODUCT SPECIFICATION: PS-45984-001.
4. PACKAGING: TRAY PER PK-45984-001.
5. SEE SHEET 5 FOR CKT IDENTIFICATION.
6. PARTS ARE RoHS COMPLIANT.
7. PEG HOLES ARE OPTIONAL SEE SHEET 3 AND 4.
8. MATES TO 1.57/.062 CARD EDGE OR MOLEX P/N 45985-4***.

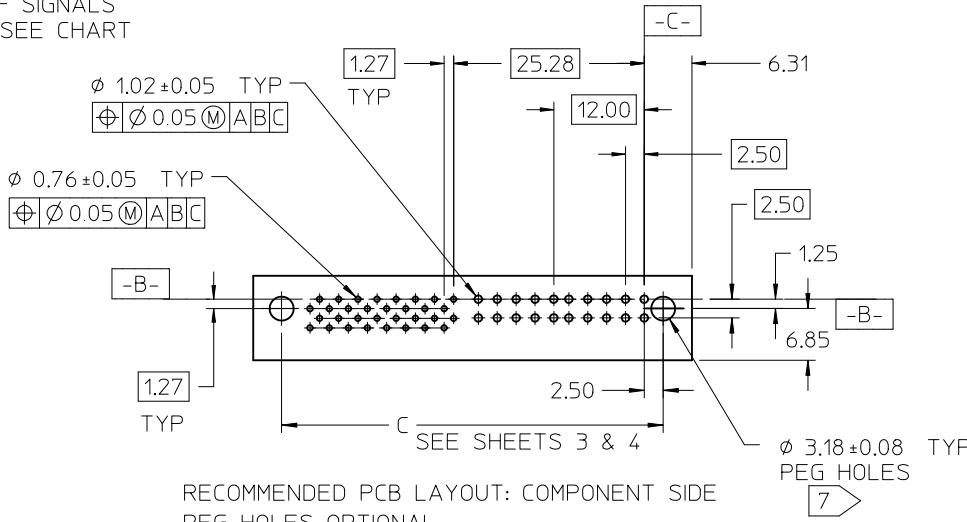
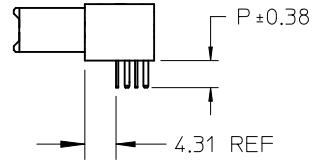
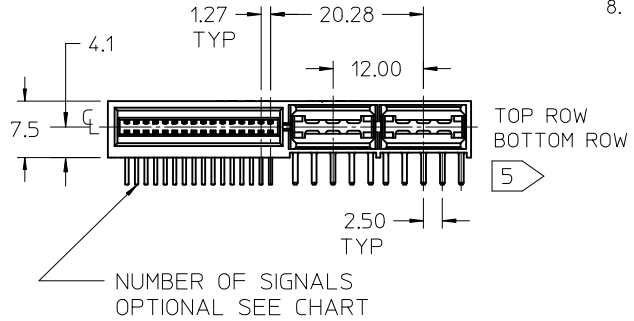

RECOMMENDED PCB LAYOUT: COMPONENT SIDE
PEG HOLES OPTIONAL

NO OF SIGNAL	MATERIAL NUMBER	DIM A REF	DIM P	PCB THK
12	45984-4111	35.5	4.50	3.18
16	45984-4121	38.0		
20	45984-4131	40.6		
24	45984-4141	43.1		
28	45984-4151	45.6		
32	45984-4161	48.2		
36	45984-4171	50.7	3.60	2.36
40	45984-4181	53.3		
12	45984-4112	35.5		
16	45984-4122	38.0		
20	45984-4132	40.6		
24	45984-4142	43.1		
28	45984-4152	45.6	2.90	1.57
32	45984-4162	48.2		
36	45984-4172	50.7		
40	45984-4182	53.3		
12	45984-4113	35.5		
16	45984-4123	38.0		
20	45984-4133	40.6		
24	45984-4143	43.1		
28	45984-4153	45.6		
32	45984-4163	48.2		
36	45984-4173	50.7		
40	45984-4183	53.3		

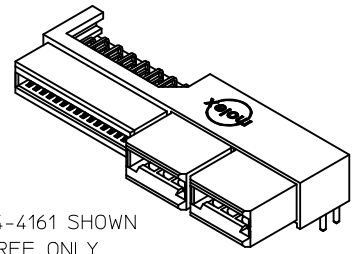

45984-4161 SHOWN FOR REF ONLY SEE CHART

MODIFY HSG NOTE	DESCRIPTION
EC NO: UCP2012-0902	
DRWN:DMORGAN 2011/09/22	
CHKD:MIBARRA 2011/09/26	
APPR:SMILLER 2011/11/09	
REV	

GENERAL TOLERANCES (UNLESS SPECIFIED)	
	mm INCH
4 PLACES	± --- ± ---
3 PLACES	± --- ± ---
2 PLACES	± 0.25 ± ---
1 PLACE	± --- ± ---
ANGULAR ±1/2°	
DRAFT WHERE APPLICABLE MUST REMAIN WITHIN DIMENSIONS	

DIMENSION STYLE	
MM ONLY	
DRAWN BY	DATE
SAMIEC	2005/05/13
CHECKED BY	DATE
SAMIEC	2005/05/13
APPROVED BY	DATE
MARGULIS	2005/05/13
MATERIAL NO.	
SEE CHART	

SCALE	DESIGN UNITS	THIRD ANGLE PROJECTION	
1:1	METRIC		
TITLE			
LPH RECEPTACLE ASSEMBLY RT ANGLE 4 CIRCUIT POWER CONNECTOR			
MOLEX INCORPORATED			
DOCUMENT NO.			SHEET NO.
SD-45984-400			1 OF 5
THIS DRAWING CONTAINS INFORMATION THAT IS PROPRIETARY TO MOLEX INCORPORATED AND SHOULD NOT BE USED WITHOUT WRITTEN PERMISSION			

NO OF SIGNAL	MATERIAL NUMBER	DIM A	DIM P	PCB THK
12	45984-4211	35.5	4.50	3.18
16	45984-4221	38.0		
20	45984-4231	40.6		
24	45984-4241	43.1		
28	45984-4251	45.6		
32	45984-4261	48.2		
36	45984-4271	50.7	3.60	2.36
40	45984-4281	53.3		
12	45984-4212	35.5		
16	45984-4222	38.0		
20	45984-4232	40.6		
24	45984-4242	43.1		
28	45984-4252	45.6	2.90	1.57
32	45984-4262	48.2		
36	45984-4272	50.7		
40	45984-4282	53.3		
12	45984-4213	35.5		
16	45984-4223	38.0		
20	45984-4233	40.6		
24	45984-4243	43.1		
28	45984-4253	45.6		
32	45984-4263	48.2		
36	45984-4273	50.7		
40	45984-4283	53.3		

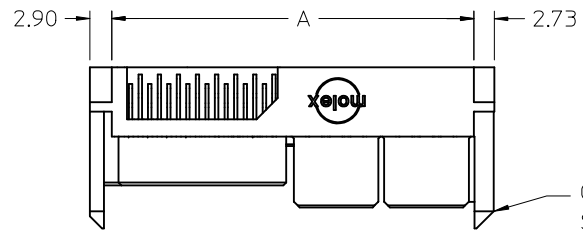

OPTIONAL GUIDES
SEE CHART

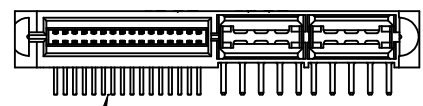

NO OF SIGNALS
OPTIONAL
SEE CHART

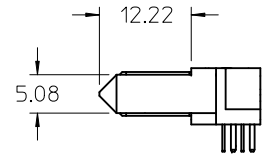

GUIDE POST OPTIONS

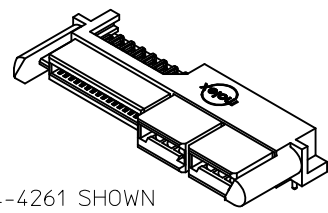

45984-4261 SHOWN
FOR REF ONLY
SEE CHART

SEE SHEET 1	DESCRIPTION
EC NO: UCP2012-0902	
DRWN:DMORGAN 2011/09/22	
CHKD:MI BARRA 2011/09/26	
APPR:SMILLER 2011/11/09	
REV	

GENERAL TOLERANCES (UNLESS SPECIFIED)		DIMENSION STYLE MM ONLY	
	mm		INCH
4 PLACES	± ---	± ---	± ---
3 PLACES	± ---	± ---	± ---
2 PLACES	± 0.25	± ---	± ---
1 PLACE	± ---	± ---	± ---
ANGULAR ±1/2°			
DRAFT WHERE APPLICABLE MUST REMAIN WITHIN DIMENSIONS			

DRAWN BY		DATE	
SAMI EC		2005/05/13	
CHECKED BY		DATE	
SAMI EC		2005/05/13	
APPROVED BY		DATE	
MARGUL IS		2005/05/13	
MATERIAL NO. SEE CHART			
SIZE	THIS DRAWING CONTAINS INFORMATION THAT IS PROPRIETARY TO MOLEX INCORPORATED AND SHOULD NOT BE USED WITHOUT WRITTEN PERMISSION		

SCALE 1:1	DESIGN UNITS METRIC	THIRD ANGLE PROJECTION	
TITLE LPH RECEPTACLE ASSEMBLY RT ANGLE 4 CIRCUIT POWER CONNECTOR			
MOLEX MOLEX INCORPORATED			
DOCUMENT NO. SD-45984-400			SHEET NO. 2 OF 5

6

5

4

3

2

1

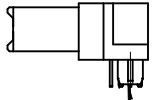
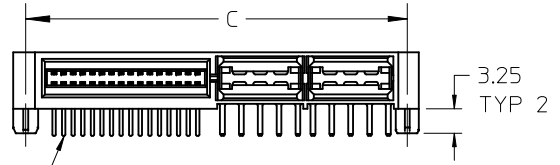
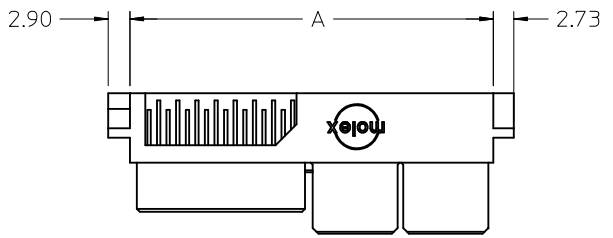

NO OF SIGNALS
OPTIONAL
SEE CHART

OPTIONAL PEGS

MOUNTING PEG OPTIONS

NO OF SIGNAL	MATERIAL NUMBER	DIM A	DIM C	DIM P	PCB THK
12	45984-4311	35.5	37.90	4.50	3.18
16	45984-4321	38.0	40.44		
20	45984-4331	40.6	42.98		
24	45984-4341	43.1	45.52		
28	45984-4351	45.6	48.06		
32	45984-4361	48.2	50.60		
36	45984-4371	50.7	53.14	3.60	2.36
40	45984-4381	53.3	55.68		
12	45984-4312	35.5	37.90		
16	45984-4322	38.0	40.44		
20	45984-4332	40.6	42.98		
24	45984-4342	43.1	45.52		
28	45984-4352	45.6	48.06	2.90	1.57
32	45984-4362	48.2	50.60		
36	45984-4372	50.7	53.14		
40	45984-4382	53.3	55.68		
12	45984-4313	35.5	37.90		
16	45984-4323	38.0	40.44		
20	45984-4333	40.6	42.98		
24	45984-4343	43.1	45.52		
28	45984-4353	45.6	48.06		
32	45984-4363	48.2	50.60		
36	45984-4373	50.7	53.14		
40	45984-4383	53.3	55.68		

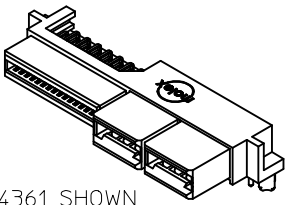

45984-4361 SHOWN
FOR REF ONLY
SEE CHART

SEE SHEET 1	DESCRIPTION
EC NO: UCP2012-0902	
DRWN:DMORGAN 2011/09/22	
CHKD:MI BARRA 2011/09/26	
APPR:SMILLER 2011/11/09	
REV	

GENERAL TOLERANCES (UNLESS SPECIFIED)	
	mm INCH
4 PLACES	± --- ± ---
3 PLACES	± --- ± ---
2 PLACES	± 0.25 ± ---
1 PLACE	± --- ± ---
ANGULAR ±1/2°	
DRAFT WHERE APPLICABLE MUST REMAIN WITHIN DIMENSIONS	

DIMENSION STYLE	
MM ONLY	
DRAWN BY	DATE
SAMIEC	2005/05/13
CHECKED BY	DATE
SAMIEC	2005/05/13
APPROVED BY	DATE
MARGULIS	2005/05/13
MATERIAL NO.	
SEE CHART	
SIZE	
A	

SCALE	DESIGN UNITS	THIRD ANGLE PROJECTION
1:1	METRIC	
TITLE		
LPH RECEPTACLE ASSEMBLY RT ANGLE 4 CIRCUIT POWER CONNECTOR		
MOLEX INCORPORATED		
DOCUMENT NO.	SHEET NO.	
SD-45984-400	3 OF 5	

5

4

3

2

1

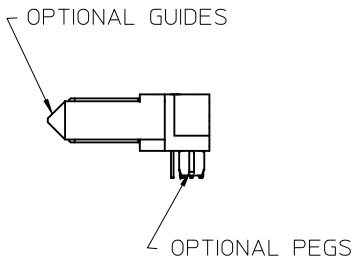
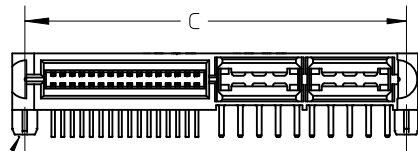
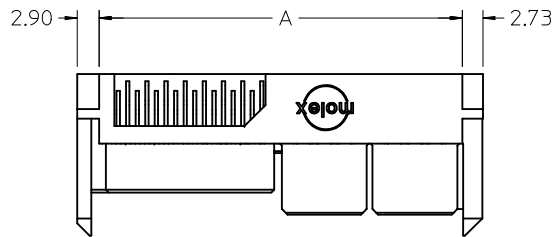

NO OF SIGNALS
OPTIONAL
SEE CHART

GUIDE POST & MOUNTING PEG OPTIONS

NO OF SIGNAL	MATERIAL NUMBER	DIM A	DIM C	DIM P	PCB THK
12	45984-4411	35.5	37.90	4.50	3.18
16	45984-4421	38.0	40.44		
20	45984-4431	40.6	42.98		
24	45984-4441	43.1	45.52		
28	45984-4451	45.6	48.06		
32	45984-4461	48.2	50.60		
36	45984-4471	50.7	53.14	3.60	2.36
40	45984-4481	53.3	55.68		
12	45984-4412	35.5	37.90		
16	45984-4422	38.0	40.44		
20	45984-4432	40.6	42.98		
24	45984-4442	43.1	45.52		
28	45984-4452	45.6	48.06	2.90	1.57
32	45984-4462	48.2	50.60		
36	45984-4472	50.7	53.14		
40	45984-4482	53.3	55.68		
12	45984-4413	35.5	37.90		
16	45984-4423	38.0	40.44		
20	45984-4433	40.6	42.98		
24	45984-4443	43.1	45.52		
28	45984-4453	45.6	48.06		
32	45984-4463	48.2	50.60		
36	45984-4473	50.7	53.14		
40	45984-4483	53.3	55.68		

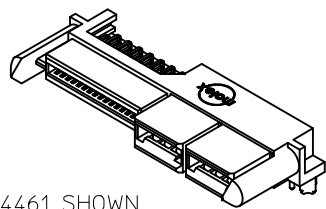

45984-4461 SHOWN
FOR REF ONLY
SEE CHART

SEE SHEET 1	DESCRIPTION
EC NO: UCP2012-0902	
DRWN:DMORGAN 2011/09/22	
CHKD:MI BARRA 2011/09/26	
APPR:SMILLER 2011/11/09	
REV	

GENERAL TOLERANCES (UNLESS SPECIFIED)		
	mm	INCH
4 PLACES	± ---	± ---
3 PLACES	± ---	± ---
2 PLACES	± 0.25	± ---
1 PLACE	± ---	± ---
ANGULAR ±1/2°		
DRAFT WHERE APPLICABLE MUST REMAIN WITHIN DIMENSIONS		

DIMENSION STYLE	
MM ONLY	
DRAWN BY	DATE
SAMIEC	2005/05/13
CHECKED BY	DATE
SAMIEC	2005/05/13
APPROVED BY	DATE
MARGULIS	2005/05/13
MATERIAL NO.	
SEE CHART	
SIZE	
A	

SCALE	DESIGN UNITS	THIRD ANGLE PROJECTION
1:1	METRIC	
TITLE		
LPH RECEPTACLE ASSEMBLY RT ANGLE 4 CIRCUIT POWER CONNECTOR		
MOLEX INCORPORATED		
DOCUMENT NO.	SHEET NO.	
SD-45984-400	4 OF 5	
THIS DRAWING CONTAINS INFORMATION THAT IS PROPRIETARY TO MOLEX INCORPORATED AND SHOULD NOT BE USED WITHOUT WRITTEN PERMISSION		

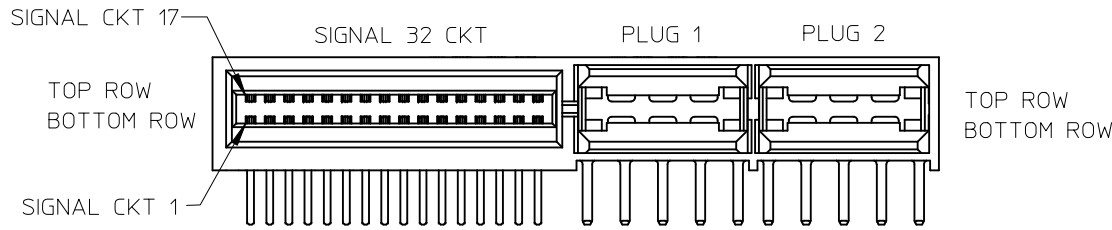

NO. OF SIGNAL	DIM. D
12	8.00
16	10.54
20	13.08
24	15.62
28	18.16
32	20.70
36	23.24
40	25.78

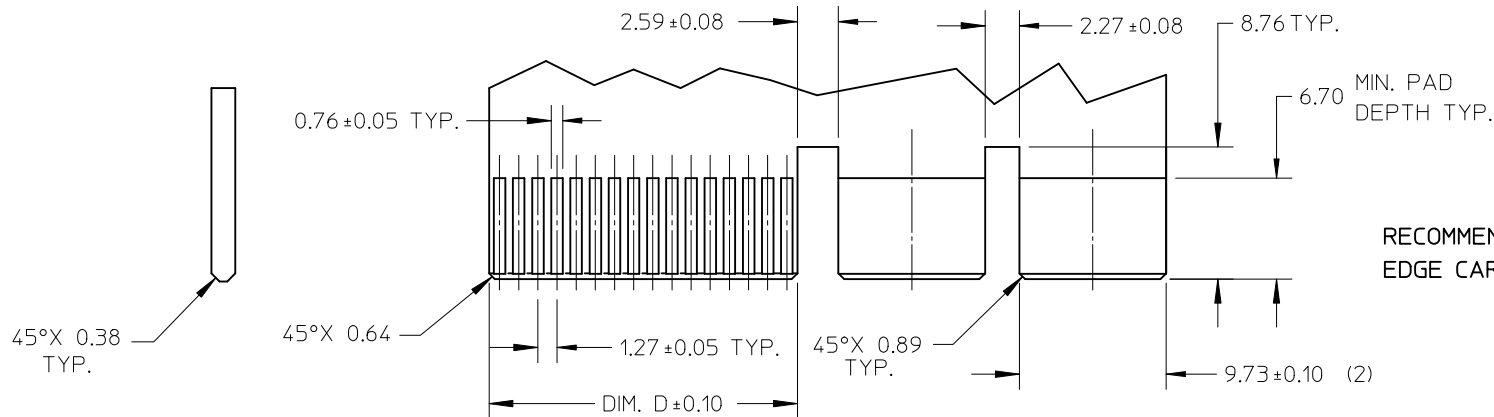

RECOMMENDED EDGE CARD LAYOUT
EDGE CARD THICKNESS: 1.57/0.62

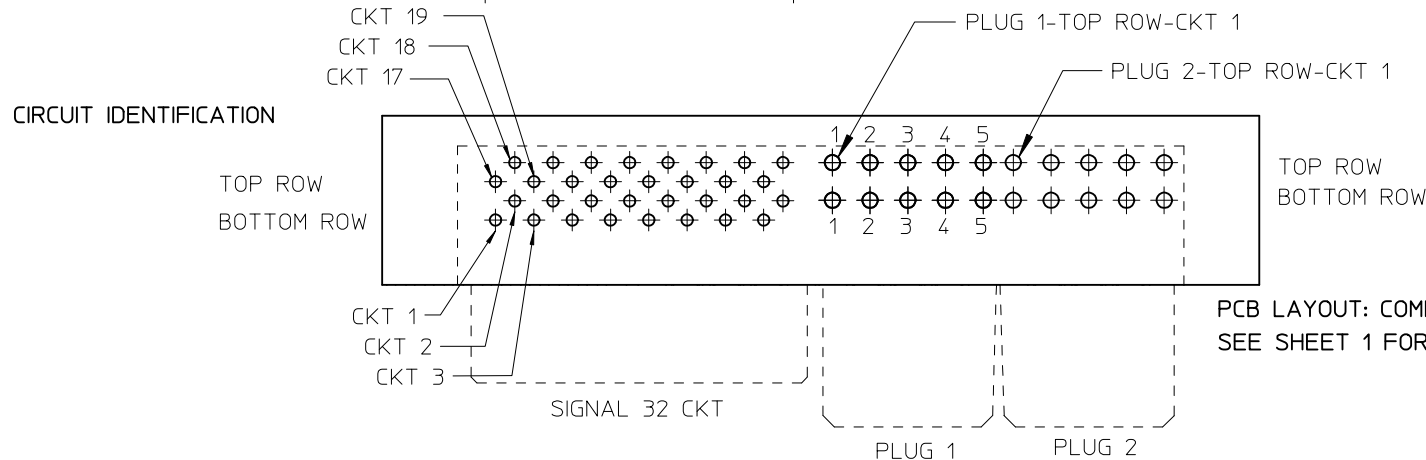

PCB LAYOUT: COMPONENT SIDE
SEE SHEET 1 FOR DIMENSIONS

SEE SHEET 1	EC NO: UCP2012-0902	DRWN:DMORGAN	2011/09/22
	CHKD:MI BARRA	2011/09/26	
	APPR:SMILLER	2011/11/09	
	DESCRIPTION		
REV			

GENERAL TOLERANCES (UNLESS SPECIFIED)		
	mm	INCH
4 PLACES	± ---	± ---
3 PLACES	± ---	± ---
2 PLACES	± 0.25	± ---
1 PLACE	± ---	± ---
ANGULAR ±1/2°		
DRAFT WHERE APPLICABLE MUST REMAIN WITHIN DIMENSIONS		

DIMENSION STYLE	
MM ONLY	
DRAWN BY	DATE
SAMIEC	2005/05/13
CHECKED BY	DATE
SAMIEC	2005/05/13
APPROVED BY	DATE
MARGULIS	2005/05/13
MATERIAL NO.	SEE CHARTS
SIZE	A

SCALE	2:1	DESIGN UNITS	METRIC	THIRD ANGLE PROJECTION
TITLE				
LPH RECEPTACLE ASSEMBLY RT ANGLE 4 CIRCUIT POWER CONNECTOR				
MOLEX INCORPORATED				
DOCUMENT NO.				SHEET NO.
SD-45984-400				5 OF 5
THIS DRAWING CONTAINS INFORMATION THAT IS PROPRIETARY TO MOLEX INCORPORATED AND SHOULD NOT BE USED WITHOUT WRITTEN PERMISSION				