



Aluminum electrolytic capacitors

Capacitors for pulse applications

Series/Type: B43415, B43416

Date: December 2016

© EPCOS AG 2016. Reproduction, publication and dissemination of this publication, enclosures hereto and the information contained therein without EPCOS' prior express consent is prohibited.

EPCOS AG is a TDK Group Company.

Application

- Medical appliances
- Professional photoflash generators

Features

- Compact design
- Outstanding reliability
- High charge/discharge proof, polar
- Low leakage current
- Low dissipation factor
- RoHS-compatible

Construction

- Aluminum case, fully insulated with PVC
- Safety vent

Terminals

- Snap-in
- Solder lug

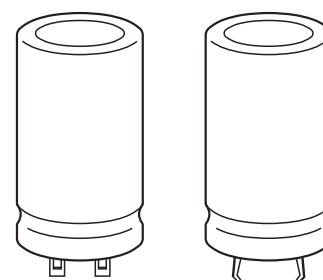

B43415
B43416
Overview

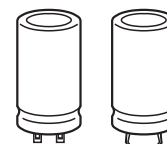
Temperature °C	Series	Useful life	V _R V DC	C _R μF
+60 (max. case temp.)	B43415 Solder lug	> 100000 discharges	300 ... 500	1000 ... 6600
	B43416 Snap-in			200 ... 1500

Specifications and characteristics in brief

Rated voltage	V_R	300 ... 500 V DC	
Rated capacitance	C_R	200 ... 6600 μ F	
Capacitance tolerance	ΔC_R	-10/+20%	
Leakage current (5 min, 20 °C)	I_{leak}	$I_{leak} \leq 0.3 \mu A \cdot \left(\frac{C_R}{\mu F} \cdot \frac{V_R}{V} \right)^{0.7} + 4 \mu A$	
Dissipation factor (20 °C, 120 Hz)	$\tan \delta$	$\leq 15\%$	
Useful life ¹⁾		> 100000 discharges at: Case temperature $\leq 60 \text{ }^\circ\text{C}$ Discharge repetition rate $\geq 2 \text{ s}$ Max. discharges per week ≤ 5000 Charge resistance $> 10 \text{ } \Omega$ Discharge resistance $> 0.5 \text{ } \Omega$	Requirements: $\Delta C/C \leq \pm 20\%$ of initial value $\tan \delta \leq 3$ times initial specified limit $I_{leak} \leq$ initial specified limit
Vibration resistance test		To IEC 60068-2-6, test Fc: Displacement amplitude 0.35 mm, frequency range 10 Hz ... 55 Hz, acceleration max. 5 g, duration 3 \times 2 h. Capacitor mounted by its body which is rigidly clamped to the work surface. If terminals are used for mechanical fixation of the capacitor, the vibration resistance can be reduced depending on capacitor size.	
IEC climatic category		$V_R \leq 400 \text{ V DC}$: 40/060/56 (-40 °C/+60 °C/56 days damp heat test) $V_R > 400 \text{ V DC}$: 25/060/56 (-25 °C/+60 °C/56 days damp heat test)	

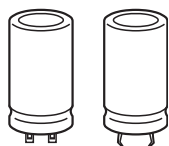
1) Refer to chapter "General technical information, 5 Useful life" on how to interpret useful life.



B43415

Compact – up to 60°C

Dimensional drawing
B43415, solder lug terminals

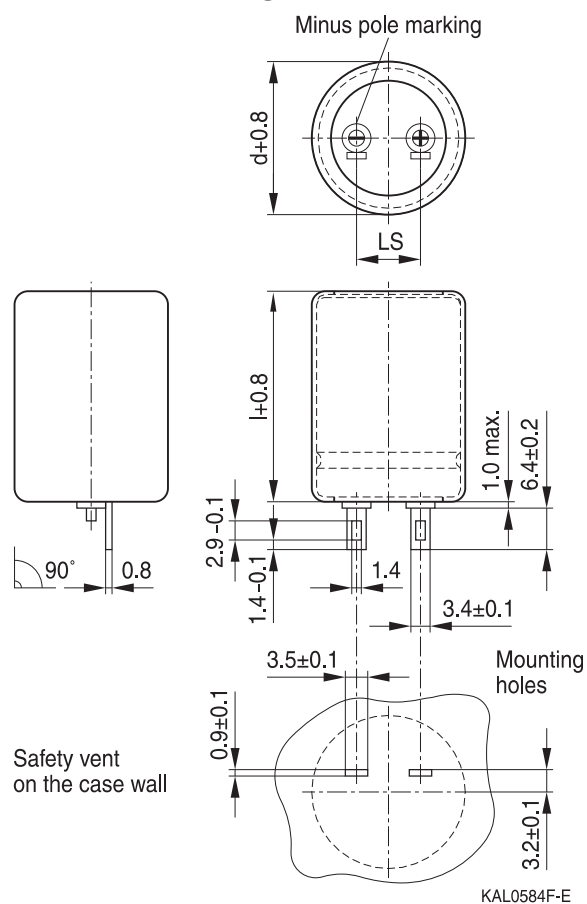

Dimensions, weights and packing units

$d \times l$ mm	Lead spacing (LS) mm	Approx. weight g	Packing units pcs.
35 × 55	10.0	75	36
35 × 65	10.0	88	36
40 × 65	10.0	115	33
40 × 70	10.0	130	33
40 × 80	10.0	150	33
40 × 90	10.0	160	33
40 × 105	10.0	180	33
40 × 110	10.0	190	33
50 × 80	20.0	230	28
50 × 100	20.0	270	28

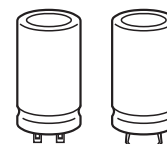
Technical data and ordering codes – B43415

C_R 100 Hz 20 °C μF	CASE_DIM $d \times l$ mm	$I_{\text{leak,max}}$ 5 min. 20 °C mA	Ordering code
$V_R = 300 \text{ V DC}$			
2100	35 × 65	3.4	B43415C3218A000
3000	40 × 70	4.4	B43415C3308A000
4700	40 × 105	6.0	B43415C3478A000
6600	50 × 100	7.7	B43415C3668A000
$V_R = 330 \text{ V DC}$			
2100	40 × 65	3.7	B43415C8218A000
3000	40 × 80	4.7	B43415C8308A000
3800	40 × 105	5.6	B43415C8388A000
5600	50 × 100	7.3	B43415C8568A000
$V_R = 360 \text{ V DC}$			
2100	40 × 65	3.9	B43415C9218A000
3000	40 × 90	5.0	B43415C9308A000
3800	40 × 110	5.9	B43415C9388A000
4900	50 × 100	7.6	B43415C9498A000
$V_R = 400 \text{ V DC}$			
1000	35 × 55	2.5	B43415C9108A000
2100	40 × 80	4.2	B43415D9218A000
3000	40 × 110	5.4	B43415D9308A000
3800	50 × 100	6.4	B43415D9388A000
$V_R = 500 \text{ V DC}$			
1000	40 × 65	2.9	B43415C6108A000
2100	50 × 80	4.9	B43415C6218A000
2500	50 × 100	5.8	B43415C6258A000

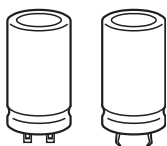

B43416

Compact – up to 60°C

Dimensional drawing
B43416, snap-in terminals

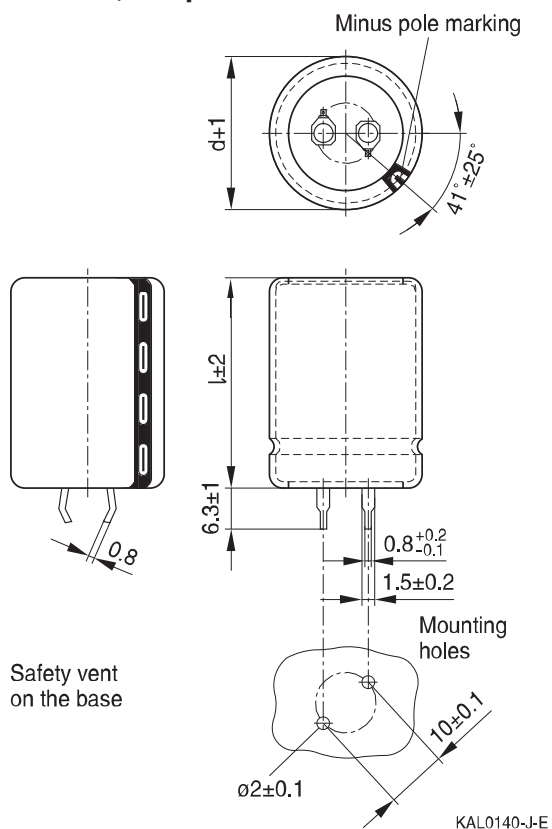

Dimensions, weights and packing units

$d \times l$	Approx. weight	Packing units
mm	g	pcs.
25 × 45	25	130
30 × 40	36	80
30 × 50	46	80
35 × 45	56	60
35 × 50	70	60
35 × 55	81	60

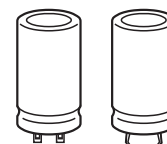
B43416
Compact – up to 60°C

Technical data and ordering codes – B43416

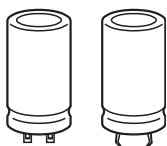
C_R 100 Hz 20 °C μF	CASE_DIM $d \times l$ mm	$I_{\text{leak,max}}$ 5 min. 20 °C mA	Ordering code
$V_R = 300 \text{ V DC}$			
1000	30 × 50	2.0	B43416C3108A000
1500	35 × 50	2.7	B43416C3158A000
$V_R = 330 \text{ V DC}$			
1000	35 × 45	2.2	B43416C8108A000
1200	35 × 50	2.5	B43416C8128A000
$V_R = 360 \text{ V DC}$			
560	30 × 40	1.5	B43416C9567A000
1100	35 × 50	2.6	B43416C9118A000
1200	35 × 55	2.8	B43416C9128A000
$V_R = 400 \text{ V DC}$			
330	25 × 45	1.2	B43416C9337A000
700	35 × 45	2.0	B43416C9707A000
900	35 × 55	2.6	B43416C9907A000
$V_R = 500 \text{ V DC}$			
200	25 × 45	0.9	B43416C6207A000
560	35 × 50	2.0	B43416C6567A000
600	35 × 55	2.1	B43416C6607A000



B43415, B43416

Compact – up to 60 °C

Packing of snap-in capacitors



Packing of solder lug capacitors



For ecological reasons the packing is pure cardboard.

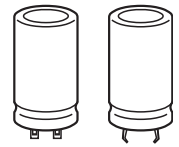

AC capacitance versus temperature

$V_R = 350$ V DC
Typical behavior

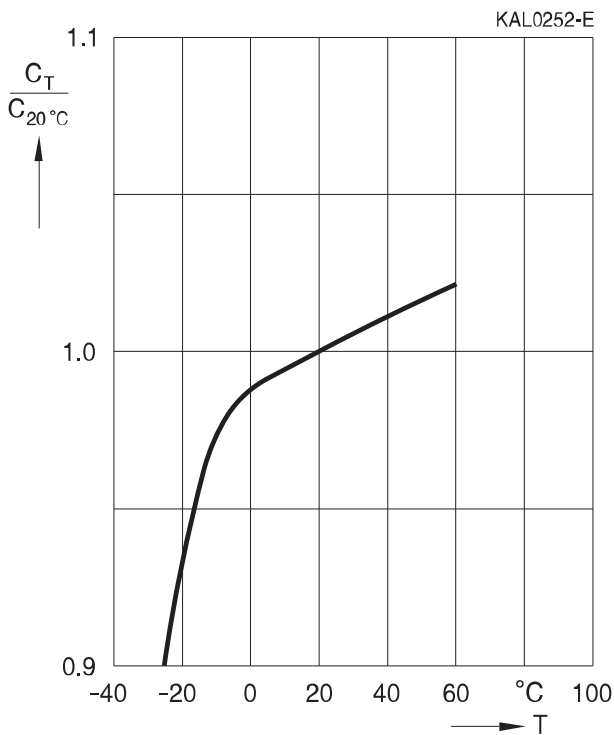

Dissipation factor $\tan \delta$ versus temperature

$V_R = 350$ V DC, measuring frequency = 120 Hz
Typical behavior

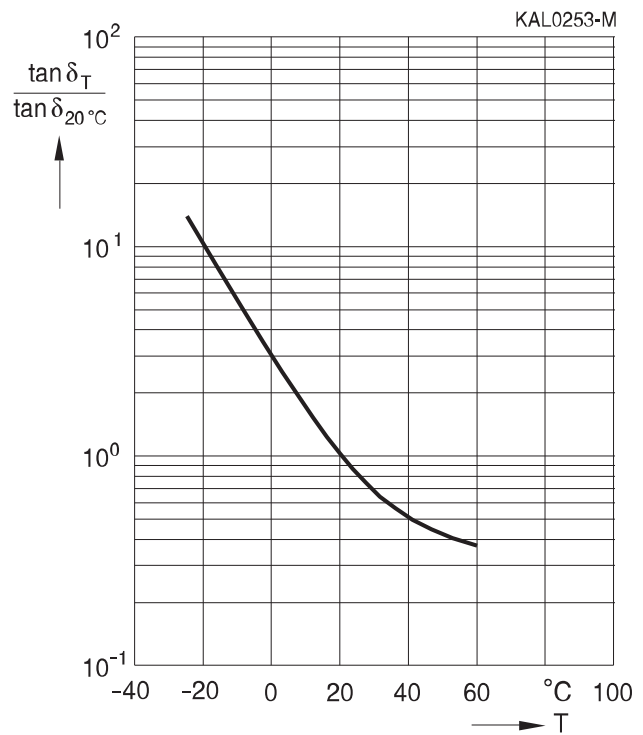

Leakage current I_{leak} versus temperature

Measurement duration = 5 minutes
Typical behavior

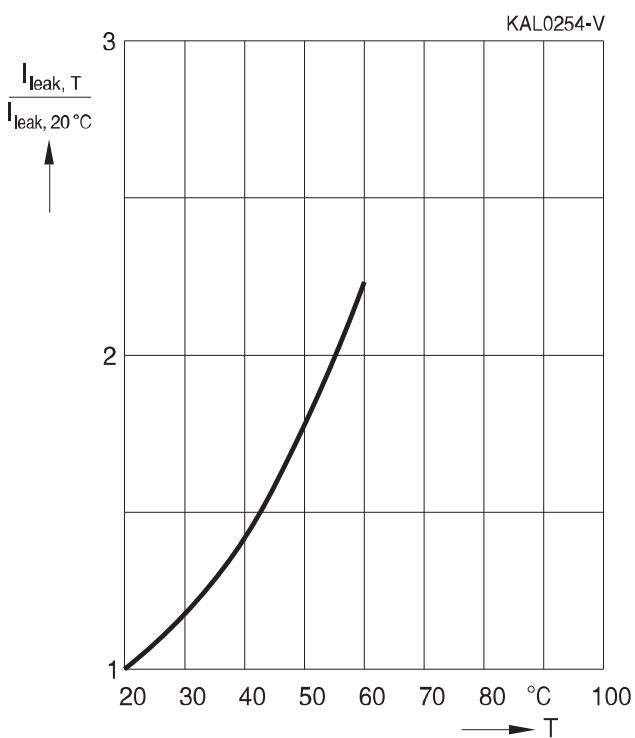

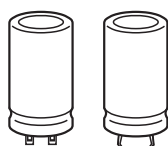

B43415, B43416

Compact – up to 60 °C

Questionnaire

Please use the questionnaire when having other, improved or additional technical requirements which cannot be covered by our standard series.

The characteristic data listed in the questionnaire below are essentially the most important information for determining design dimensions of electrolytic capacitors for professional photo flash applications.

Rated capacitance per capacitor _____ μF
 Rated voltage per capacitor _____ V DC
 Charge/discharge voltage _____ / _____ V
 Required dimensions: Diameter (max.) _____ mm
 Length (max.) _____ mm
 Style of terminals _____
 Ambient temperature _____ °C
 Method of cooling _____

Discharge conditions

Internal resistance of the discharge tube (if applicable) _____ Ω
 Charging resistance (series resistance) _____ Ω
 No. of capacitors in series _____
 No. of capacitors in parallel _____
 Flash sequence _____
 Pause periods _____
 Other special operating conditions _____
 Expected useful life _____ flashes
 Annual demand of capacitors _____

For any further support, please contact your nearest EPCOS representative.

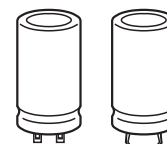

Cautions and warnings

Personal safety

The electrolytes used by EPCOS have been optimized both with a view to the intended application and with regard to health and environmental compatibility. They do not contain any solvents that are detrimental to health, e.g. dimethyl formamide (DMF) or dimethyl acetamide (DMAC).

Furthermore, some of the high-voltage electrolytes used by EPCOS are self-extinguishing.

As far as possible, EPCOS does not use any dangerous chemicals or compounds to produce operating electrolytes, although in exceptional cases, such materials must be used in order to achieve specific physical and electrical properties because no alternative materials are currently known. We do, however, restrict the amount of dangerous materials used in our products to an absolute minimum.

Materials and chemicals used in EPCOS aluminum electrolytic capacitors are continuously adapted in compliance with the EPCOS Corporate Environmental Policy and the latest EU regulations and guidelines such as RoHS, REACH/SVHC, GADSL, and ELV.

MDS (Material Data Sheets) are available on the EPCOS website for all types listed in the data book. MDS for customer specific capacitors are available upon request.

MSDS (Material Safety Data Sheets) are available for all of our electrolytes upon request.

Nevertheless, the following rules should be observed when handling aluminum electrolytic capacitors: No electrolyte should come into contact with eyes or skin. If electrolyte does come into contact with the skin, wash the affected areas immediately with running water. If the eyes are affected, rinse them for 10 minutes with plenty of water. If symptoms persist, seek medical treatment. Avoid inhaling electrolyte vapor or mists. Workplaces and other affected areas should be well ventilated. Clothing that has been contaminated by electrolyte must be changed and rinsed in water.

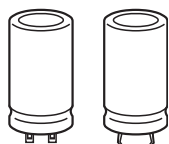

B43415, B43416

Compact – up to 60 °C

Product safety

The table below summarizes the safety instructions that must be observed without fail. A detailed description can be found in the relevant sections of chapter "General technical information".

Topic	Safety information	Reference chapter "General technical information"
Polarity	Make sure that polar capacitors are connected with the right polarity.	1 "Basic construction of aluminum electrolytic capacitors"
Reverse voltage	Voltages of opposite polarity should be prevented by connecting a diode.	3.1.6 "Reverse voltage"
Mounting position of screw-terminal capacitors	Screw terminal capacitors must not be mounted with terminals facing down unless otherwise specified.	11.1. "Mounting positions of capacitors with screw terminals"
Robustness of terminals	The following maximum tightening torques must not be exceeded when connecting screw terminals: M5: 2.5 Nm M6: 4.0 Nm	11.3 "Mounting torques"
Mounting of single-ended capacitors	The internal structure of single-ended capacitors might be damaged if excessive force is applied to the lead wires. Avoid any compressive, tensile or flexural stress. Do not move the capacitor after soldering to PC board. Do not pick up the PC board by the soldered capacitor. Do not insert the capacitor on the PC board with a hole space different to the lead space specified.	11.4 "Mounting considerations for single-ended capacitors"
Soldering	Do not exceed the specified time or temperature limits during soldering.	11.5 "Soldering"
Soldering, cleaning agents	Do not allow halogenated hydrocarbons to come into contact with aluminum electrolytic capacitors.	11.6 "Cleaning agents"
Upper category temperature	Do not exceed the upper category temperature.	7.2 "Maximum permissible operating temperature"
Passive flammability	Avoid external energy, e.g. fire.	8.1 "Passive flammability"

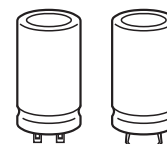

Topic	Safety information	Reference chapter "General technical information"
Active flammability	Avoid overload of the capacitors.	8.2 "Active flammability"
Maintenance	Make periodic inspections of the capacitors. Before the inspection, make sure that the power supply is turned off and carefully discharge the capacitors. Do not apply excessive mechanical stress to the capacitor terminals when mounting.	10 "Maintenance"
Storage	Do not store capacitors at high temperatures or high humidity. Capacitors should be stored at +5 to +35 °C and a relative humidity of ≤ 75%.	7.3 "Shelf life and storage conditions"
		Reference chapter "Capacitors with screw terminals"
Breakdown strength of insulating sleeves	Do not damage the insulating sleeve, especially when ring clips are used for mounting.	"Screw terminals – accessories"

Display of ordering codes for EPCOS products

The ordering code for one and the same product can be represented differently in data sheets, data books, other publications and the website of EPCOS, or in order-related documents such as shipping notes, order confirmations and product labels. The varying representations of the ordering codes are due to different processes employed and do not affect the specifications of the respective products.

Detailed information can be found on the Internet under www.epcos.com/orderingcodes.

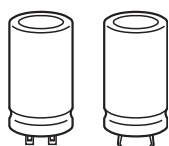

B43415, B43416

Compact – up to 60 °C

Symbols and terms

Symbol	English	German
C	Capacitance	Kapazität
C_R	Rated capacitance	Nennkapazität
C_S	Series capacitance	Serienkapazität
$C_{S,T}$	Series capacitance at temperature T	Serienkapazität bei Temperatur T
C_f	Capacitance at frequency f	Kapazität bei Frequenz f
d	Case diameter, nominal dimension	Gehäusedurchmesser, Nennmaß
d_{max}	Maximum case diameter	Maximaler Gehäusedurchmesser
ESL	Self-inductance	Eigeninduktivität
ESR	Equivalent series resistance	Ersatzserienwiderstand
ESR_f	Equivalent series resistance at frequency f	Ersatzserienwiderstand bei Frequenz f
ESR_T	Equivalent series resistance at temperature T	Ersatzserienwiderstand bei Temperatur T
f	Frequency	Frequenz
I	Current	Strom
I_{AC}	Alternating current (ripple current)	Wechselstrom
$I_{AC,RMS}$	Root-mean-square value of alternating current	Wechselstrom, Effektivwert
$I_{AC,f}$	Ripple current at frequency f	Wechselstrom bei Frequenz f
$I_{AC,max}$	Maximum permissible ripple current	Maximal zulässiger Wechselstrom
$I_{AC,R}$	Rated ripple current	Nennwechselstrom
I_{leak}	Leakage current	Reststrom
$I_{leak,op}$	Operating leakage current	Betriebsreststrom
l	Case length, nominal dimension	Gehäuselänge, Nennmaß
l_{max}	Maximum case length (without terminals and mounting stud)	Maximale Gehäuselänge (ohne Anschlüsse und Gewindebolzen)
R	Resistance	Widerstand
R_{ins}	Insulation resistance	Isolationswiderstand
R_{symm}	Balancing resistance	Symmetrierwiderstand
T	Temperature	Temperatur
ΔT	Temperature difference	Temperaturdifferenz
T_A	Ambient temperature	Umgebungstemperatur
T_C	Case temperature	Gehäusetemperatur
T_B	Capacitor base temperature	Temperatur des Gehäusebodens
t	Time	Zeit
Δt	Period	Zeitraum
t_b	Service life (operating hours)	Brauchbarkeitsdauer (Betriebszeit)

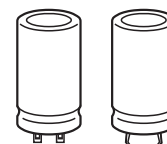

Symbol	English	German
V	Voltage	Spannung
V_F	Forming voltage	Formierspannung
V_{op}	Operating voltage	Betriebsspannung
V_R	Rated voltage, DC voltage	Nennspannung, Gleichspannung
V_S	Surge voltage	Spitzenspannung
X_C	Capacitive reactance	Kapazitiver Blindwiderstand
X_L	Inductive reactance	Induktiver Blindwiderstand
Z	Impedance	Scheinwiderstand
Z_T	Impedance at temperature T	Scheinwiderstand bei Temperatur T
$\tan \delta$	Dissipation factor	Verlustfaktor
λ	Failure rate	Ausfallrate
ϵ_0	Absolute permittivity	Elektrische Feldkonstante
ϵ_r	Relative permittivity	Dielektrizitätszahl
ω	Angular velocity; $2 \cdot \pi \cdot f$	Kreisfrequenz; $2 \cdot \pi \cdot f$

Note

All dimensions are given in mm.

Important notes

The following applies to all products named in this publication:

1. Some parts of this publication contain **statements about the suitability of our products for certain areas of application**. These statements are based on our knowledge of typical requirements that are often placed on our products in the areas of application concerned. We nevertheless expressly point out **that such statements cannot be regarded as binding statements about the suitability of our products for a particular customer application**. As a rule, EPCOS is either unfamiliar with individual customer applications or less familiar with them than the customers themselves. For these reasons, it is always ultimately incumbent on the customer to check and decide whether an EPCOS product with the properties described in the product specification is suitable for use in a particular customer application.
2. We also point out that **in individual cases, a malfunction of electronic components or failure before the end of their usual service life cannot be completely ruled out in the current state of the art, even if they are operated as specified**. In customer applications requiring a very high level of operational safety and especially in customer applications in which the malfunction or failure of an electronic component could endanger human life or health (e.g. in accident prevention or lifesaving systems), it must therefore be ensured by means of suitable design of the customer application or other action taken by the customer (e.g. installation of protective circuitry or redundancy) that no injury or damage is sustained by third parties in the event of malfunction or failure of an electronic component.
3. **The warnings, cautions and product-specific notes must be observed.**
4. In order to satisfy certain technical requirements, **some of the products described in this publication may contain substances subject to restrictions in certain jurisdictions (e.g. because they are classed as hazardous)**. Useful information on this will be found in our Material Data Sheets on the Internet (www.epcos.com/material). Should you have any more detailed questions, please contact our sales offices.
5. We constantly strive to improve our products. Consequently, **the products described in this publication may change from time to time**. The same is true of the corresponding product specifications. Please check therefore to what extent product descriptions and specifications contained in this publication are still applicable before or when you place an order. We also **reserve the right to discontinue production and delivery of products**. Consequently, we cannot guarantee that all products named in this publication will always be available. The aforementioned does not apply in the case of individual agreements deviating from the foregoing for customer-specific products.
6. Unless otherwise agreed in individual contracts, **all orders are subject to the current version of the "General Terms of Delivery for Products and Services in the Electrical Industry" published by the German Electrical and Electronics Industry Association (ZVEI)**.

Important notes

7. The trade names EPCOS, CeraDiode, CeraLink, CeraPad, CeraPlas, CSMP, CSSP, CTVS, DeltaCap, DigiSiMic, DSSP, ExoCore, FilterCap, FormFit, LeaXield, MiniBlue, MiniCell, MKD, MKK, MotorCap, PCC, PhaseCap, PhaseCube, PhaseMod, PhiCap, PQSine, SIFERRIT, SIFI, SIKOREL, SilverCap, SIMDAD, SiMic, SIMID, SineFormer, SIOV, SIP5D, SIP5K, TFAP, ThermoFuse, WindCap are **trademarks registered or pending** in Europe and in other countries. Further information will be found on the Internet at www.epcos.com/trademarks.