



Voidless-Hermetically-Sealed Unidirectional 150 W Low-Capacitance Transient Voltage Suppressors

DESCRIPTION

This series of voidless-hermetically-sealed unidirectional low-capacitance Transient Voltage Suppressor (TVS) designs are ideal for protecting higher frequency applications in high-reliability applications where a failure cannot be tolerated. They include a unique rectifier diode in series and opposite direction from the TVS to achieve a very low capacitance of 4 pF. This product series provides a working peak “standoff” voltage selection from 6.8 to 170 volts with 150 watt ratings. They are very robust in hard-glass construction and also use an internal metallurgical bond identified as Category 1 for high reliability applications. These devices are also available in axial leaded packages for thru-hole mounting.

Important: For the latest information, visit our website <http://www.microsemi.com>.

FEATURES

- High surge current and peak pulse power unidirectional protection for sensitive circuits.
- Very low capacitance for high frequency or high baud rate applications.
- Bidirectional capability with two devices in anti-parallel (see Figure 5).
- Triple-layer passivation.
- Internal “Category 1” metallurgical bonds.
- Voidless hermetically sealed glass package.
- RoHS compliant versions are available.

APPLICATIONS / BENEFITS

- High reliability transient protection.
- Extremely robust construction.
- Working peak “standoff” voltage (V_{WM}) from 6.8 to 170 volts.
- Available as 150 W peak pulse power (P_{PP}) at 10/1000 μ s.
- Lowest available capacitance for 150 W rated TVS.
- ESD and EFT protection per IEC61000-4-2 and IEC61000-4-4 respectively.
- Secondary lightning protection per select levels in IEC61000-4-5.
- Flexible axial-leaded mounting terminals.
- Nonsensitive to ESD per MIL-STD-750 method 1020.
- Inherently radiation hard as described in Microsemi [MicroNote 050](#).

MAXIMUM RATINGS

Parameters/Test Conditions	Symbol	Value	Unit
Junction and Storage Temperature	T_J and T_{STG}	-55 to +175	$^{\circ}$ C
Capacitance at zero volts	C	4	pF
Thermal Resistance junction to ambient	$R_{\theta JA}$	150	$^{\circ}$ C/W
Peak Pulse Power at 25 $^{\circ}$ C (10 μ s/1000 μ s)	P_{PP}	150	W
Impulse repetition rate (duty factor)	d.f	0.01	%
Steady State (Average) Power @ $T_A = 25^{\circ}$ C	$P_{M(AV)}$	1.0	W
Solder Temperature (10 s maximum)		260	$^{\circ}$ C

Note: Steady-state power ratings with reference to ambient are for PC boards where thermal resistance from mounting point to ambient is sufficiently controlled where $T_{J(MAX)}$ is not exceeded.



“A” Package

Also available in:

“A” MELF package
(surface mount)

 1N8149US – 1N8182US

MSC – Lawrence

6 Lake Street,
Lawrence, MA 01841
1-800-446-1158
(978) 620-2600
Fax: (978) 689-0803

MSC – Ireland

Gort Road Business Park,
Ennis, Co. Clare, Ireland
Tel: +353 (0) 65 6840044
Fax: +353 (0) 65 6822298

Website:

www.microsemi.com

MECHANICAL and PACKAGING

- CASE: Hermetically sealed voidless hard glass with tungsten slugs.
- TERMINALS: Axial-leads are tin/lead or RoHS compliant matte/tin plating over copper.
- MARKING: Body paint and part number
- POLARITY: Cathode band
- MOUNTING: Any position
- TAPE & REEL option: Standard per EIA-296.
- WEIGHT: Approximately 340 milligrams.
- See [Package Dimensions](#) on last page.

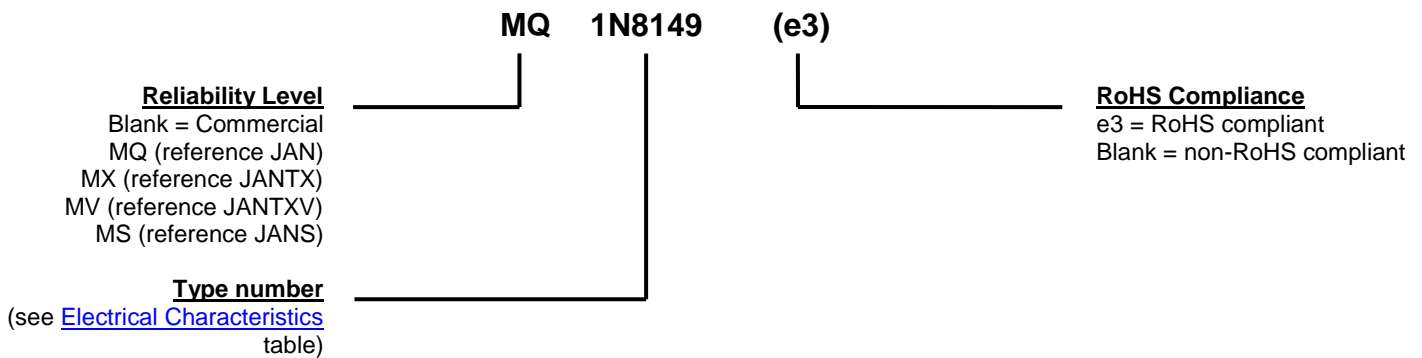
PART NOMENCLATURE

SYMBOLS & DEFINITIONS

Symbol	Definition
$\alpha_{V(BR)}$	Temperature Coefficient of Breakdown Voltage: The change in breakdown voltage divided by the change in temperature that caused it expressed in %/°C or mV/°C.
$V_{(BR)}$	Breakdown Voltage: The voltage across the device at a specified current $I_{(BR)}$ in the breakdown region.
V_{WM}	Working Standoff Voltage: The maximum-rated value of dc or repetitive peak positive cathode-to-anode voltage that may be continuously applied over the standard operating temperature.
I_D	Standby Current: The current through the device at rated stand-off voltage.
$I_{(BR)}$	Breakdown Current: The current used for measuring Breakdown Voltage $V_{(BR)}$
I_{PP}	Peak Impulse Current: The maximum rated random recurring peak impulse current or nonrepetitive peak impulse current that may be applied to a device. A random recurring or nonrepetitive transient current is usually due to an external cause, and it is assumed that its effect will have completely disappeared before the next transient arrives.
V_C	Clamping Voltage: The voltage across the device in a region of low differential resistance during the application of an impulse current (I_{PP}) for a specified waveform.
P_{PP}	Peak Pulse Power. The rated random recurring peak impulse power or rated nonrepetitive peak impulse power. The impulse power is the maximum-rated value of the product of I_{PP} and V_C .
C_T	Total Capacitance: The total small signal capacitance between the diode terminals of a complete device.
V_{WIB}	Inverse Blocking Voltage: The maximum-rated value of dc or peak blocking voltage in the inverse direction.
I_{IB}	Blocking Leakage Current: The current through the device at the rated inverse blocking voltage (V_{WIB}).

ELECTRICAL CHARACTERISTICS @ T_A = 25°C unless otherwise noted.

Type Number	Minimum Breakdown Voltage (V _{BR})	Breakdown Current (I _{BR})	Working Standoff Voltage (V _{WM})	Maximum Standby Current (I _D)	Maximum Peak Clamping Voltage (V _C)	Maximum Surge Current (I _{PP})	Maximum V _{BR} Temperature Coefficient (α _{V(BR)})	Capacitance (C _T)	Inverse Blocking Voltage (V _{WIB})	Blocking Leakage Current (I _{IB})
	V	mA	V	μA	V	A	%/°C	pF	V	μA
1N8149	7.79	10	6.8	20	12.8	11.7	.065	4	300	1
1N8150	8.65	1	7.5	10	13.5	11.1	.068	4	300	1
1N8151	9.50	1	8.5	10	14.5	10.3	.073	4	300	1
1N8152	10.4	1	9.0	5	15.6	9.62	.075	4	300	1
1N8153	11.4	1	10.0	1	16.9	8.88	.078	4	300	1
1N8154	12.4	1	11.0	1	18.2	8.24	.081	4	300	1
1N8155	13.8	1	12.0	1	20.2	7.42	.084	4	300	1
1N8156	15.2	1	13.0	1	22.3	6.73	.086	4	300	1
1N8157	17.1	1	15.0	1	25.1	5.98	.088	4	300	1
1N8158	19.0	1	17.0	0.5	27.7	5.42	.090	4	300	1
1N8159	20.9	1	18.0	0.5	30.5	4.92	.092	4	300	1
1N8160	22.8	1	20.0	0.5	33.3	4.50	.094	4	300	1
1N8161	25.7	1	22.0	0.5	37.4	4.01	.096	4	300	1
1N8162	28.5	1	25.0	0.5	41.6	3.60	.097	4	300	1
1N8163	31.4	1	28.0	0.5	45.7	3.28	.098	4	300	1
1N8164	34.2	1	30.0	0.5	49.9	3.01	.099	4	300	1
1N8165	37.1	1	33.0	0.5	53.6	2.80	.100	4	300	1
1N8166	40.9	1	36.0	0.5	59.1	2.54	.101	4	300	1
1N8167	44.7	1	40.0	0.5	64.6	2.32	.101	4	300	1
1N8168	48.5	1	43.0	0.5	70.1	2.14	.102	4	300	1
1N8169	53.2	1	47.0	0.5	77.0	1.95	.103	4	300	1
1N8170	58.9	1	53.0	0.5	85.3	1.76	.104	4	300	1
1N8171	64.6	1	58.0	0.5	93.7	1.60	.104	4	300	1
1N8172	71.3	1	64.0	0.5	103.0	1.45	.105	4	300	1
1N8173	77.9	1	70.0	0.5	113.0	1.32	.105	4	300	1
1N8174	86.5	1	75.0	0.5	125.0	1.20	.105	4	300	1
1N8175	95.0	1	82.0	0.5	137.0	1.09	.106	4	300	1
1N8176	104.0	1	94.0	0.5	152.0	0.98	.107	4	300	1
1N8177	114.0	1	100.0	0.5	168.0	0.89	.107	4	300	1
1N8178	124.0	1	110.0	0.5	183.0	0.82	.107	4	300	1
1N8179	138.0	1	120.0	0.5	208.0	0.72	.108	4	300	1
1N8180	152.0	1	130.0	0.5	225.0	0.67	.108	4	300	1
1N8181	171.0	1	150.0	0.5	261.0	0.57	.108	4	300	1
1N8182	190.0	1	170.0	0.5	294.0	0.51	.108	4	300	1

GRAPHS

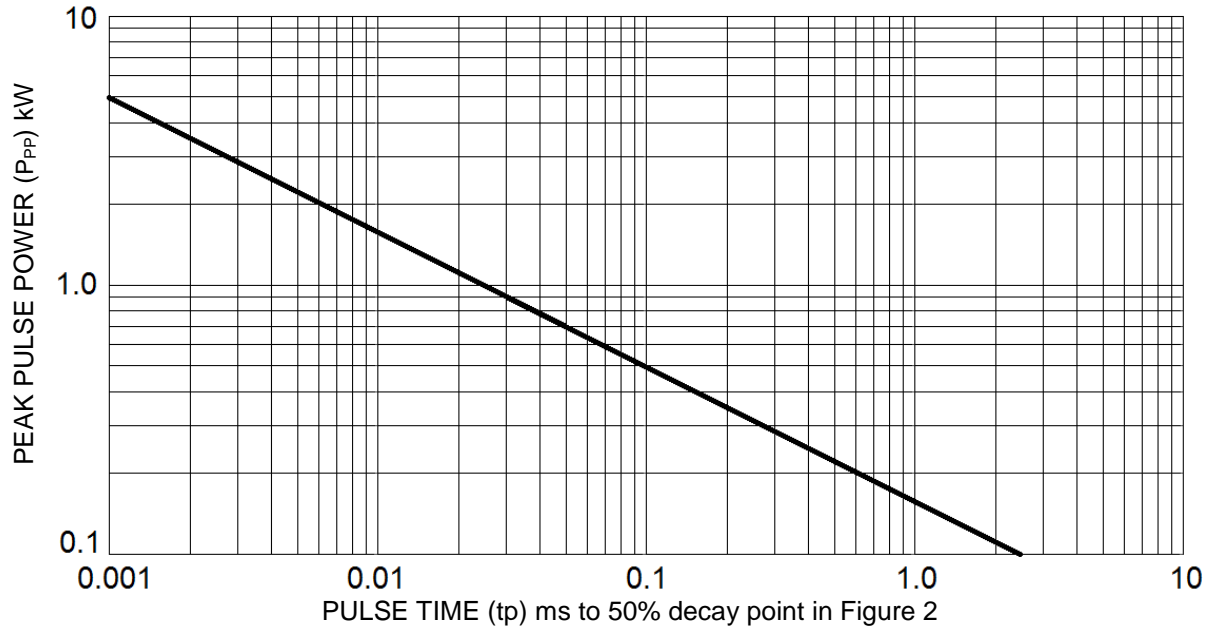

FIGURE 1
PEAK PULSE POWER VS. PULSE TIME

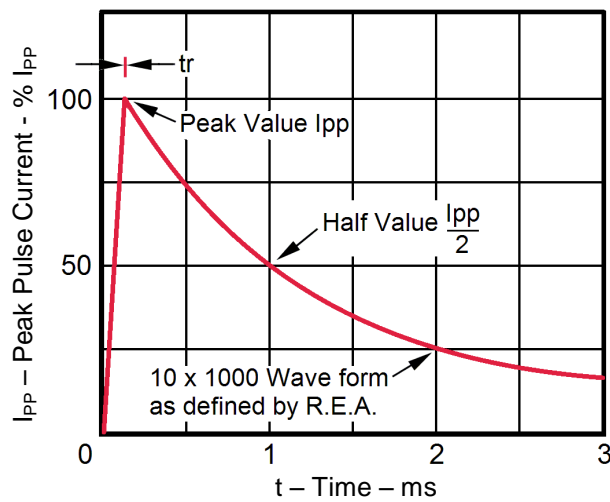

FIGURE 2
10/1000µs CURRENT IMPULSE WAVEFORM

GRAPHS

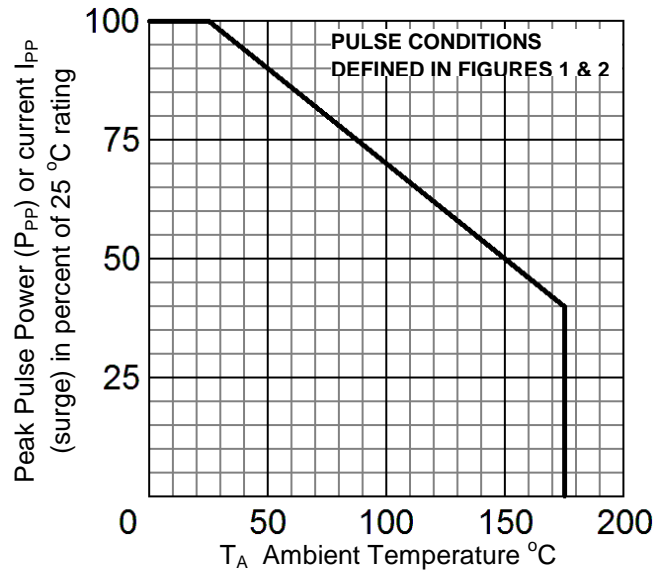

FIGURE 3
DERATING CURVE

SCHEMATIC APPLICATIONS

The TVS low capacitance device configuration described in this data sheet is shown in Figure 4 involving a TVS and a unique diode in series and opposite direction. For bidirectional low capacitance TVS applications, use two (2) low capacitance TVS devices as described in this data sheet in anti-parallel as shown in Figure 5. This will result in twice the capacitance of Figure 4 specified in this data sheet.

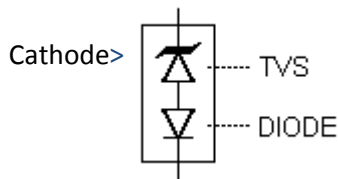

FIGURE 4
Low Capacitance TVS

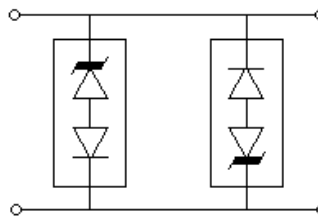
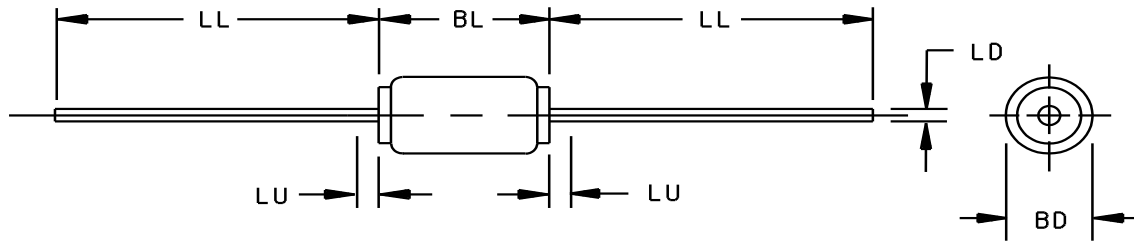

FIGURE 5
Bidirectional configuration
(2 Low Capacitance TVS
devices in anti-parallel)

PACKAGE DIMENSIONS

NOTES:

1. Dimensions are in inches.
2. Millimeters are given for general information only.
3. Dimension BD shall be measured at the largest diameter.
4. Dimension LU lead diameter uncontrolled in this area.
5. In accordance with ASME Y14.5M, diameters are equivalent to Φ x symbology.

Ltr	Dimensions				Notes
	Inches		Millimeters		
	Min	Max	Min	Max	
BD	0.060	0.085	1.52	2.16	3
BL	0.106	0.175	2.69	4.45	
LD	0.028	0.032	0.71	0.81	
LL	0.800	1.300	20.32	33.02	
LU		0.050		1.27	4