

Model 73054

TNC Right-Angle Plug, 50 Ohm, Crimp Type, RG55, 142, 223, 400

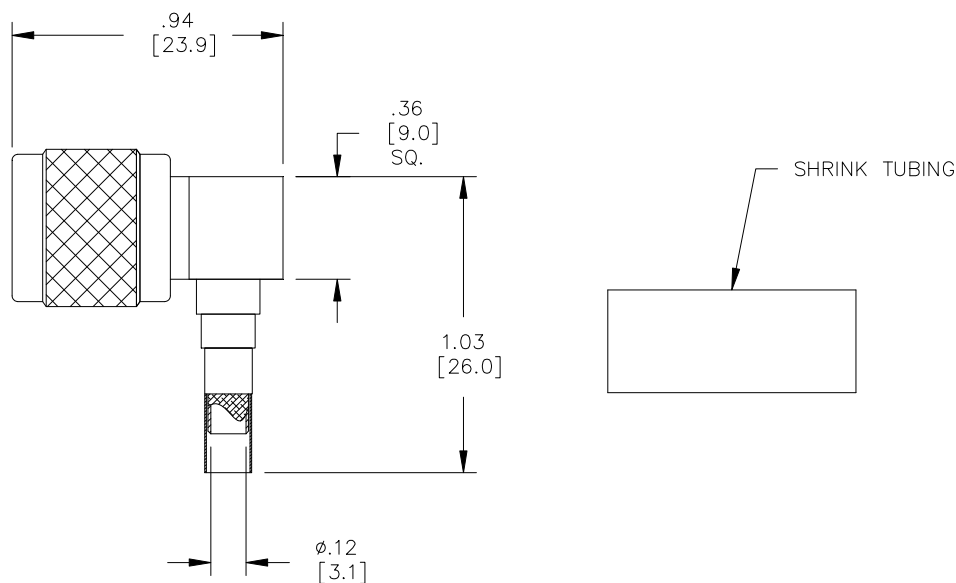

*Model 73054
TNC Right-Angle Plug, 50 Ohm, Crimp Type,
RG55, 142, 223, 400*

Features

- DC – 6GHz bandwidth.
- Connectors are precision machined.
- Meets interface requirements MIL-C-39012.
- Connector accepts cable types RG/U: 55, 142, 223, 400

Materials

Center Conductor, Male: Brass, Gold Plated
Connector Body: Brass, Nickel Plated
Crimp Ferrule: Copper, Nickel Plated
Insulators: PTFE
Gasket: Silicone Rubber

Specifications

Impedance:	50Ω
Frequency Range:	DC – 6GHz
Contact Resistance:	
Center Conductor:	≤1.5 mΩ
Outer Conductor:	≤0.2 mΩ
Insulation Resistance:	≥ 5000 MΩ
Dielectric Withstand Voltage:	1500V
<i>For CE compliance, do not hold in hand when voltages exceed 33 Vrms / 70 Vdc.</i>	
VSWR:	≤1.5
Number of Insertions:	500 cycles minimum

Ordering Information

Model: **73054**

USA: Sales: 800-490-2361
Technical Support: technicalsupport@pomonatest.com
Fax: 425-446-5844

Europe: 31-(0) 40 2675 150 **International:** 425-446-5500

Where to Buy: www.pomonaelectronics.com

All dimensions are in inches. Tolerances (except noted): .xx = ±.02" (.51 mm), .xxx = ± .005" (.127 mm). All specifications are to the latest revisions. Specifications are subject to change without notice. Registered trademarks are the property of their respective companies.

Model 73054

TNC Right-Angle Plug, 50 Ohm, Crimp Type, RG55, 142, 223, 400

Cable Types and Crimp Die Information

Connector Model #	Cable Groups	Crimp Die Cavity Size for Outer Ferrule
73054	RG55, 142, 223, 400	.230 (5.9)

Cable Assembly Instructions

1. CUT CABLE END EVENLY AND PERPENDICULAR

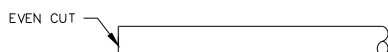

2. SLIDE FERRULE AND SHRINK TUBING OVER CABLE.

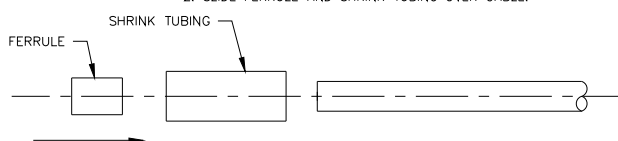

3. STRIP CABLE JACKET, BRAID AND DIELECTRIC TO SPECIFICATION LENGTHS.

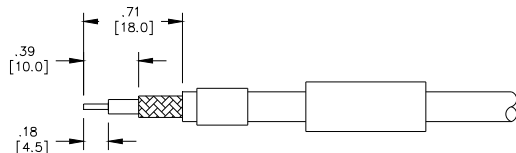

4. FLARE BRAD END SLIGHTLY.

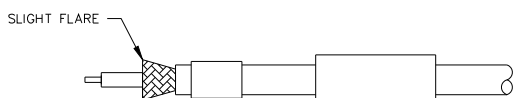

5. SLIDE CONNECTOR BODY OVER CENTER CONDUCTOR.

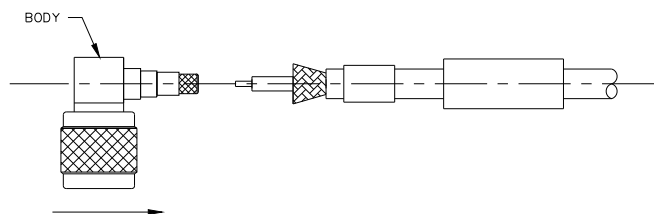

6. SLIDE OUTER FERRULE OVER BRAID AND UP AGAINST BODY ASSEMBLY.

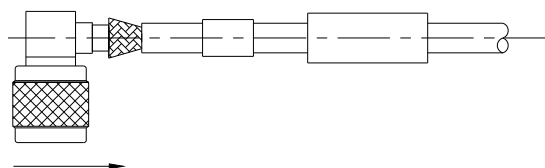

7. CRIMP FERRULE WITH APPROPRIATE CRIMP TOOL. SLIDE SHRINK TUBING OVER CRIMP AND SHRINK.

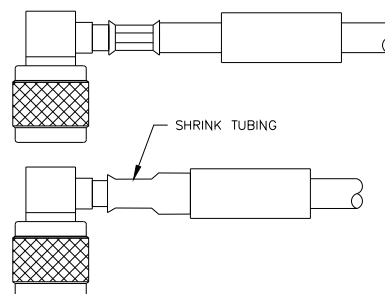

USA: Sales: 800-490-2361
 Technical Support: technicalsupport@pomonatest.com
 Fax: 425-446-5844
Europe: 31-(0) 40 2675 150 **International:** 425-446-5500
Where to Buy: www.pomonaelectronics.com

All dimensions are in inches. Tolerances (except noted): .xx = ±.02" (.51 mm), .xxx = ±.005" (.127 mm). All specifications are to the latest revisions. Specifications are subject to change without notice. Registered trademarks are the property of their respective companies.