

Circuit Breaker for Equipment thermal, Rocker actuation, 3 poles



### Description

- Thermal circuit breaker
- 3-pole
- Snap-in version
- Positively trip-free release
- Different rocker colours
- High configurability
- Wide current range

### Standards

- Approval Reference Type: TA35
- IEC 60934
- UL 1077
- CSA C22.2 No. 235
- GB 17701

### Applications

- Power tools
- Industrial appliances
- Equipment for construction
- Cleaning equipment
- Commercial and household kitchen appliances

### Weblinks

[pdf datasheet](#), [html-datasheet](#), [General Product Information](#), [Approvals](#), [CE declaration of conformity](#), [RoHS](#), [CHINA-RoHS](#), [REACH](#), [Distributor-Stock-Check](#), [Detailed request for product](#), [Product News](#)

### Technical Data

Rated Voltage AC	415 Y / 240 V; 50/60 Hz	Overload	IEC: min. 40 trips @ 6 x I <sub>r</sub> , cos φ 0.6
Rated current range AC	0.05 - 12 A		UL / CSA: min. 50 trips @ 1.5 x I <sub>r</sub> , cos φ 0.75
Conditional short circuit capacity	0.05...12 A: 2 kA @ 415 VAC	Ambient temperature	-30°C to 60°C
Degree of Protection	from front side IP 40 acc. to IEC 60529	Vibration Resistance	± 0.75 mm @ 10 - 60 Hz acc. to IEC 60068-2-6, test Tc 10 G @ 60 - 500 Hz acc. to IEC 60068-2-6, test Tc
Dielectric Strength	50Hz: > 2.5 kV Impulse 1.2/50 μs: > 4 kV	Shock Resistance	30 G / 18 ms acc. to IEC 60068-2-27, test Ea
Insulation resistance	500VDC > 100 MΩ	Tripping Type	Thermal
Endurance typical	mechanical: 50'000 switching cycles AC: 1 x I <sub>r</sub> , cos φ 0.6: 50'000 switching cycles DC: 1 x I <sub>r</sub> , L/R = 2 - 3 ms: 50'000 switching cycles	Actuation Type	Rocker
		Weight	43.0 - 45.0g

Detailed information on product approvals, code requirements, usage instructions and detailed test conditions can be looked up in [General Product Information](#)

### Dimension

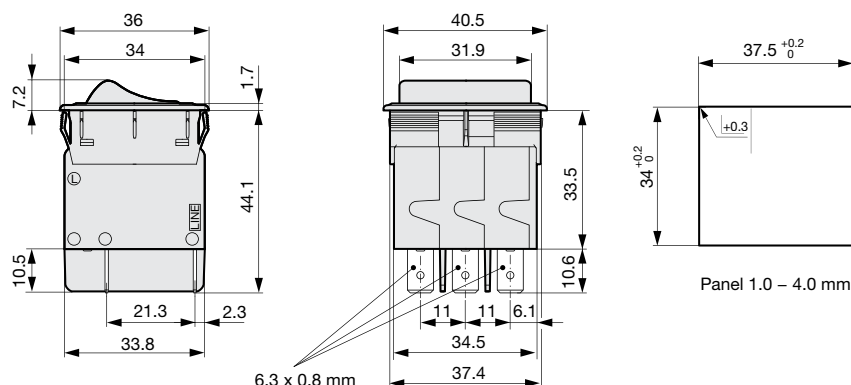

## Diagrams

3-pole, 3 bimetal, illuminated

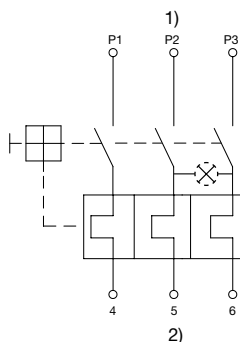

1) Line, 2) Load  
Codepos AAA = CD1



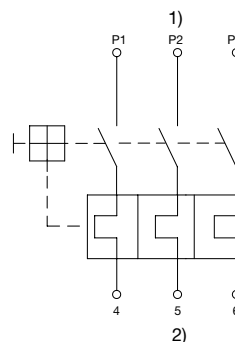

3-pole, 3 bimetal, non illuminated



1) Line, 2) Load  
Codepos AAA = CKD, CLD

The keys / codepos are listed in the key table of the basic function for selection.

## Approvals

Approval		Rated current	Rated voltage AC	Rated voltage DC
 US	UL 1077	0.05...12 A	415 Y/ 240 V	-
 US	CSA C22.2 235	0.05...12 A	415 Y/ 240 V	-
	IEC 60934	0.05...12 A	415 Y/ 240 V	-
	GB 17701	0.05...12 A	415 Y/ 240 V	-

## Typical internal resistance

Rated Current [A]	Internal Resistance [ $\Omega$ ]
0.05	200.000
0.1	70.000
0.5	2.750
1.0	0.720
1.5	0.340
2.0	0.187
2.5	0.115
2.8	0.089
3.0	0.059
4.0	0.059
5.0	0.044
6.0	0.028
7.0	0.0142
8.0	0.0142
10.0	0.0109
12.0	0.0086
13.0	0.0072
14.0	0.0072
15.0	0.0056
16.0	0.0056
18.0	0.0052
20.0	0.0052

TA35 Rocker 3-poles max. 12 A

### Effect of ambient temperature

The units are calibrated for an ambient temperature of +23°C. To determine the rated current for a lower or higher ambient temperature, use a correction factor (typical value) from the table below:

Ambient temperature [°C]	Correction factor
-30	0.76
-20	0.81
0	0.90
+23	1.00
+40	1.06
+50	1.10
+60	1.14

Example: Rated current = 5 A; Environmental temperature = 50 °C; --> Correction factor = 1.10; Resulting current = 5.2 A --> Fount to next higher rated current: 6 A

### Time-Current-Curves

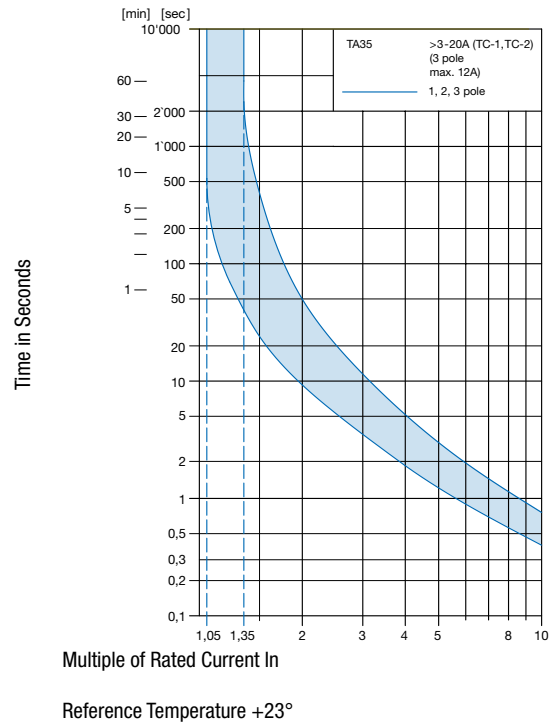
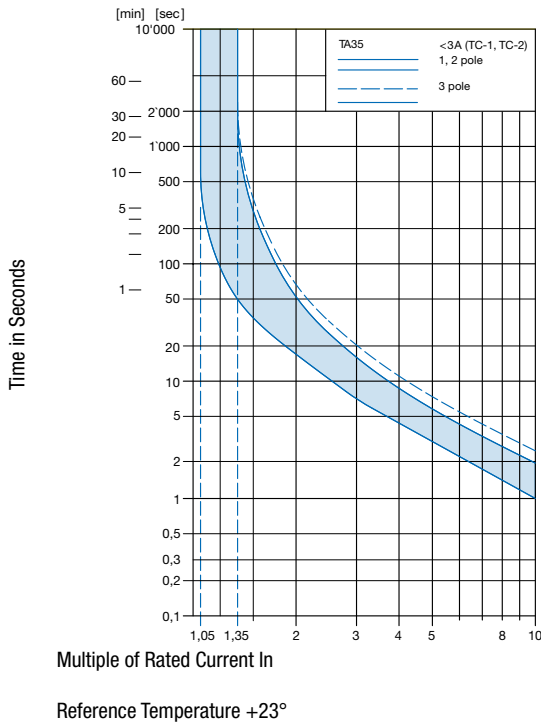

### Config. Code

TA35 - CBD B F 120 C0 - CZMXX

The characters are placeholders for the correspondingly keys of selections from the key tables.

TA35 - **CBD** B F 120 C0 - CZMXX = Basic function

Basic function	Configuration key
3-pole, 3 bimetal, illuminated 415 V	CD1
3-pole, 3 bimetal, without illumination	CKD
3-pole, 3 bimetal, momentary switch, without illumination	CLD

TA35 - CBD **B** F 120 C0 - CZMXX = Rocker colour

Rocker colour	Configuration key
Clear transparent	1

Rocker colour	Configuration key
Red transparent	3
Green transparent	4
Orange transparent	6
Blue transparent	7
Black	B
Green	G
Red	R
White	W
Orange	X
Yellow	Y

## TA35 - CBD B F 120 C0 - CZMXX = Legend

Legend	Configuration key
embossed	F
white printed	H
black printed	K
white printed	L
black printed	M

## TA35 - CBD B F 120 C0 - CZMXX = Rated current

Rated current	Configuration key
without thermal overload protection / temporarily without VDE approval	C00
0.05 A	Z05
0.1 A	J01
0.2 A	J02
0.3 A	J03
0.4 A	J04
0.5 A	J05
0.8 A	J08
1.0 A	J10
1.2 A	J12

Other rated currents on request

Rated current	Configuration key
1.5 A	J15
2.0 A	J20
2.5 A	J25
3.0 A	030
3.5 A	035
4.0 A	040
5.0 A	050
6.0 A	060
7.0 A	070
8.0 A	080
10.0 A	100
12.0 A	120

Other rated currents on request

## TA35 - CBD B F 120 C0 - CZMXX = Reserve

Reserve	Configuration key
reserve	C0

## TA35 - CBD B F 120 C0 - CZMXX = Accessories

Factory mounted accessories	Configuration key
Without cover	

For subsequent fitting accessories see:

[http://www.schurter.ch//accessory\\_cbe](http://www.schurter.ch//accessory_cbe)

## All Variants

Basic function	Rocker colour	Legend	Rated current	Accessories	Config. Code	Order Number
3-pole, 3 bimetal, without illumination	Black	white printed	2.5 A	Without cover	TA35-CKDBHJ25C0	4435.0229
3-pole, 3 bimetal, without illumination	White	embossed	3.0 A	Without cover	TA35-CKDWF030C0	4435.0025
3-pole, 3 bimetal, without illumination	Black	white printed	4.0 A	Without cover	TA35-CKDBH040C0	4435.0232
3-pole, 3 bimetal, without illumination	White	embossed	5.0 A	Without cover	TA35-CKDWF050C0	4435.0044
3-pole, 3 bimetal, without illumination	Black	white printed	5.0 A	Without cover	TA35-CKDBH050C0	4435.0048
3-pole, 3 bimetal, without illumination	Black	white printed	6.0 A	Without cover	TA35-CKDBH060C0	4435.0233
3-pole, 3 bimetal, without illumination	White	embossed	10.0 A	Without cover	TA35-CKDWF100C0	4435.0050
3-pole, 3 bimetal, without illumination	Black	white printed	10.0 A	Without cover	TA35-CKDBH100C0	4435.0235
3-pole, 3 bimetal, without illumination	White	embossed	12.0 A	Without cover	TA35-CKDWF120C0	4435.0017
3-pole, 3 bimetal, illuminated 415 V	Red transparent	white printed	12.0 A	Without cover	TA35-CD13L120C0	4435.0414

Most Popular.

Availability for all products can be searched real-time: <http://www.schurter.com/en/Stock-Check/Stock-Check-SCHURTER>

**Packaging Unit** 10 Pcs

## Accessories

### Description



[TA35 Accessories](#)

Screw-on collar with cover, IP65

---