

図面番号 (DRAWING NO.) SJ114446

| 版数<br>VER. | 年月日<br>DATE | CN NO. | 変更内容<br>DESCRIPTION | 製図<br>DR. | 担当<br>CHK. | 査閲<br>APPD. | 承認<br>APPD. |
|------------|-------------|--------|---------------------|-----------|------------|-------------|-------------|
|            |             |        |                     |           |            |             |             |

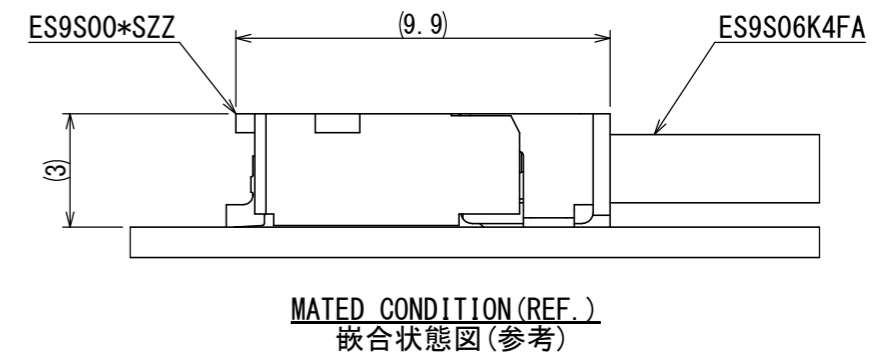
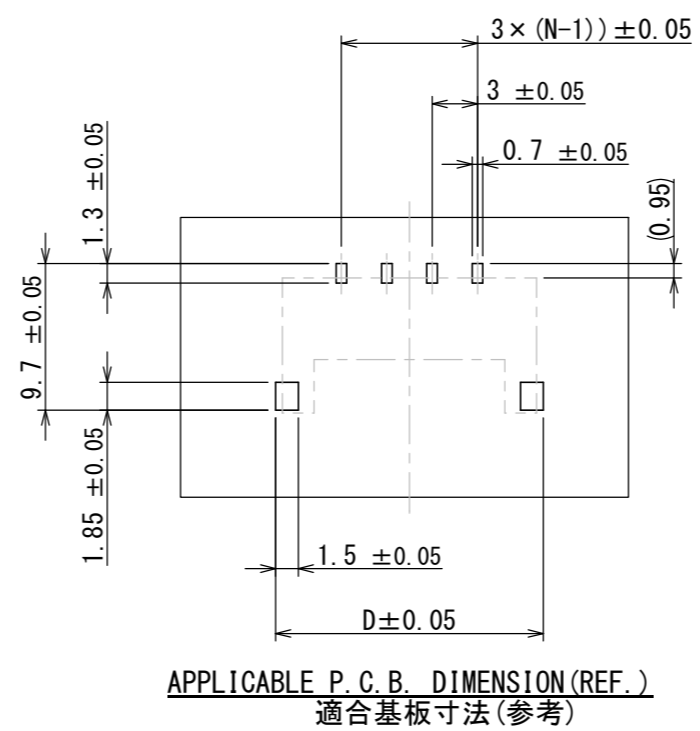
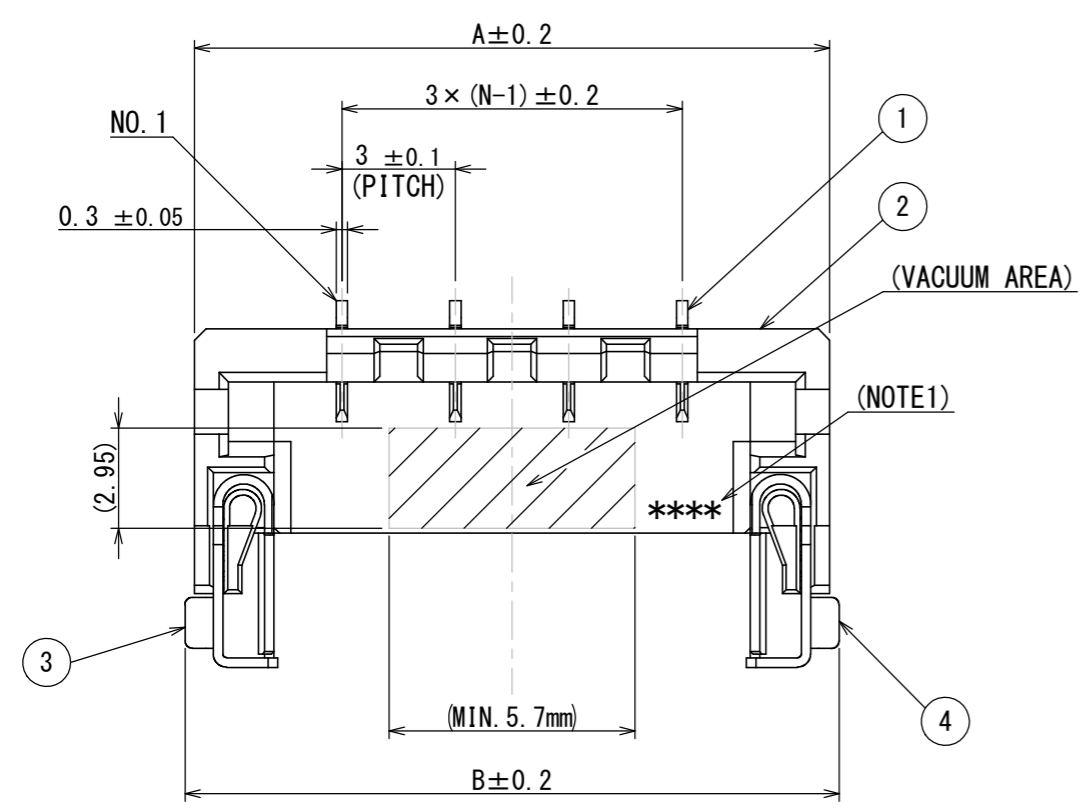
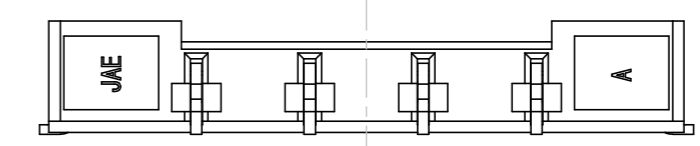
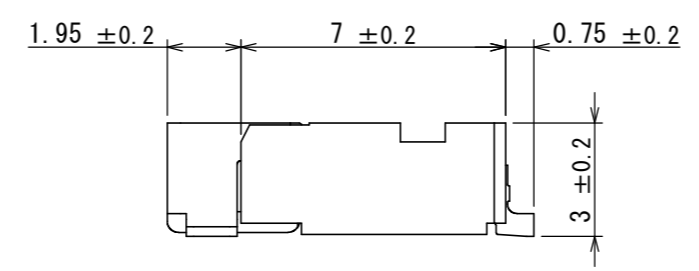
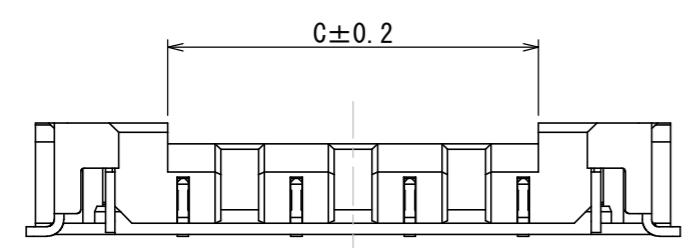
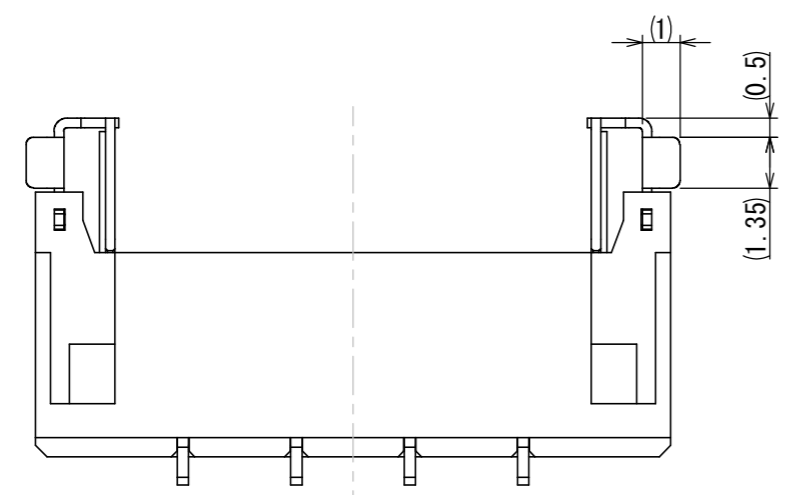

TABLE1

| NO. OF CONTACTS | A    | B    | C   | D    |
|-----------------|------|------|-----|------|
| 2               | 10.8 | 11.3 | 7.3 | 11.7 |
| 4               | 16.8 | 17.3 | 9.8 | 17.7 |



NOTE1. LOT MARKING  
注1. 組立ロットを表示する



| 符号<br>NO. | 名称<br>DESCRIPTION | 個数<br>QTY. | 材料<br>MATERIAL | 仕上<br>FINISH                | 備考<br>REMARKS |
|-----------|-------------------|------------|----------------|-----------------------------|---------------|
| 4         | HOLD DOWN R       | 1          | COPPER ALLOY   | LEAD FREE TIN ALLOY PLATING |               |
| 3         | HOLD DOWN L       | 1          | COPPER ALLOY   | LEAD FREE TIN ALLOY PLATING |               |
| 2         | INSULATOR         | 1          | LCP            |                             | COLOR: IVORY  |
| 1         | CONTACT           | TABLE1     | COPPER ALLOY   | LEAD FREE TIN ALLOY PLATING |               |

|   |  |                                    |  |                          |  |                      |  |  |  |                         |
|---|--|------------------------------------|--|--------------------------|--|----------------------|--|--|--|-------------------------|
| 仕様書 (SPECIFICATION)<br>JACS-11001<br>JABL-11001 |  | 第1版 (ORIGINAL DATE)<br>29/AUG/2013 |  | 尺度 (SCALE)<br>5:1        |  | シリーズ (SERIES)<br>ES9 |  | 日本航空電子工業株式会社                                     |  | SIZE<br>A3              |
| 一般公差 (GENERAL TOLERANCE)                        |  | 製図<br>DR.                          |  | 名称 (TITLE)<br>ES9P00*VFZ |  | 質量 (MASS)            |  | JAE<br>JAPAN AVIATION ELECTRONICS INDUSTRY, LTD. |  |                         |
| 寸法 (DIMENSION)                                  |  | 担当<br>CHK.<br>T. URANO             |  | 査閲<br>APPD.<br>H. KANNO  |  |                      |  |  |  | 承認<br>APPD.<br>T. KUDOU |
| 角度 (ANGLES)                                     |  | 単位 (UNIT) : mm                     |  |                          |  | 版数 (VER.)<br>1       |  |  |  |                         |

DCF-C-212H(12.08)

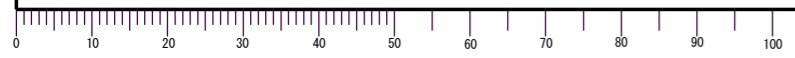

WISDOM承認 2013/09/03