

UG6KB05 THRU UG6KB100
Single-Phase 6.0A Glass Passivated Bridge Rectifier

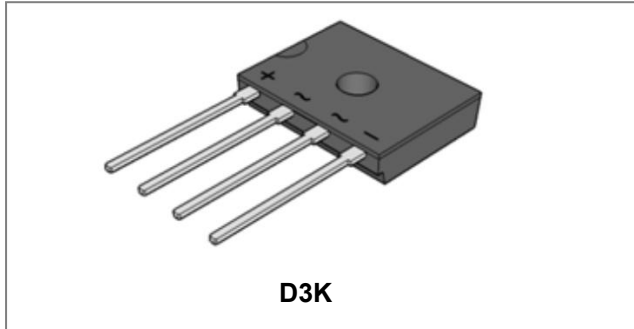

Features

- Glass passivated die construction
- Low forward voltage drop
- High current capability
- High surge current capability
- Designed for surface mount application
- Plastic material-UL flammability 94V-0
- This is a Pb – Free Device
- All SMC parts are traceable to the wafer lot
- Additional testing can be offered upon request

Circuit Diagram

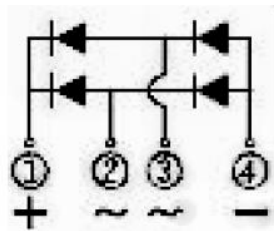

Mechanical Data

- Case: D3K, Molded plastic
- Terminals: Plated leads solderable per MIL-STD-202, Method 208
- Polarity: as marked on case
- Mounting Position: Any
- Lead Free: For RoHS / Lead Free Version

Maximum Ratings: @T_A=25°C unless otherwise specified

Single Phase, half wave, 60Hz, resistive or inductive load. For capacitive load, derate current by 20%.

Type Number	Symbol	UG6K B05	UG6K B10	UG6K B20	UG6K B40	UG6K B60	UG6K B80	UG6K B100	Units
Peak Repetitive Reverse Voltage Working Peak Reverse Voltage DC Blocking Voltage	V_{RRM} V_{RWM} V_{DC}	50	100	200	400	600	800	1000	V
RMS Reverse Voltage	V_{RMS}	35	70	140	280	420	560	700	V
Average Rectified Output Current Without heat sink @T _A = 30°C With heat sink @T _A = 140°C	I_O	3.0 6.0							A
Non-Repetitive Peak Forward Surge Current 8.3ms Single half sine-wave superimposed on rated load (JEDEC Method)	I_{FSM}	150							A

Electrical Characteristics:

Type Number	Symbol	UG6K B05	UG6K B10	UG6K B20	UG6K B40	UG6K B60	UG6K B80	UG6K B100	Units	
Forward Voltage (per element) * @ $I_F = 6.0A$	V_F					1.1				V
Peak Reverse Current * @ $T_A = 25^\circ C$ At Rated DC Blocking Voltage * @ $T_A = 125^\circ C$	I_R					5.0 500				μA
Typical Junction Capacitance(per leg) (Note 1)	C_J					21				pF

* Pulse width < 300 μs , duty cycle < 2%

Thermal-Mechanical Specifications:

Type Number	Symbol	UG6K B05	UG6K B10	UG6K B20	UG6K B40	UG6K B60	UG6K B80	UG6K B100	Units	
Typical Thermal Resistance (per leg)(Note 2)	$R_{\theta JA}$ $R_{\theta JL}$					55 15				$^\circ C/W$
Operating and Storage Temperature Range	T_J, T_{STG}					-55 to +150				$^\circ C$

Note: 1. Measured at 1.0 MHz and applied reverse voltage of 4.0V D.C.
2. Mounted on glass epoxy PC board with 1.3mm² solder pad.

Ratings and Characteristics Curves

Fig. 1 Output Current Derating Curve

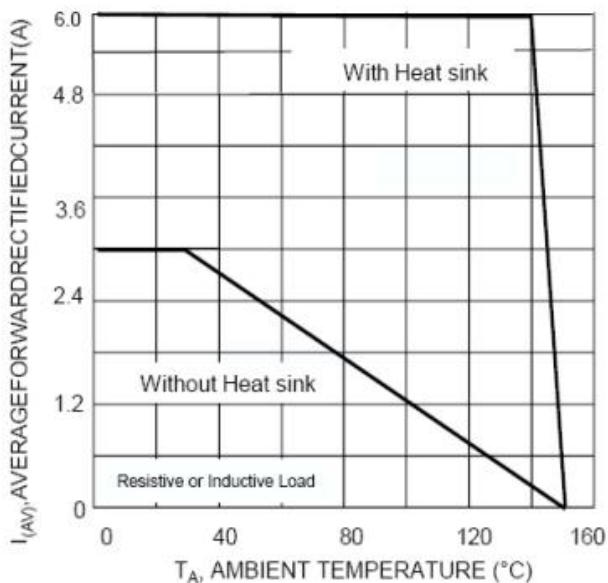
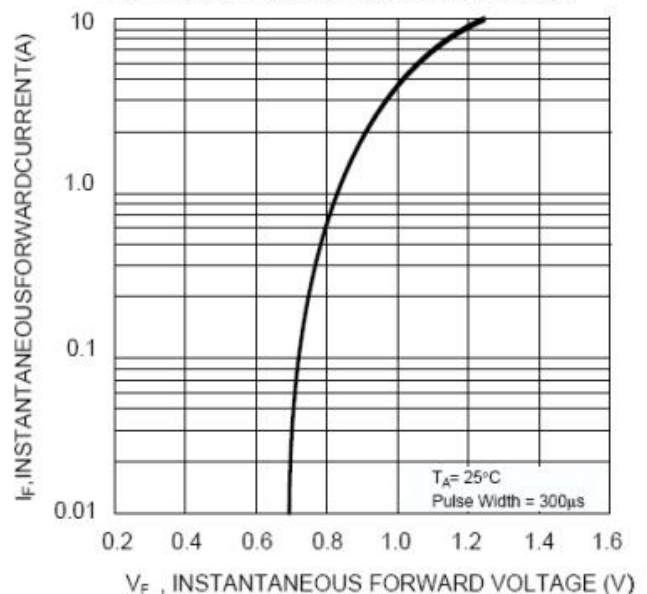
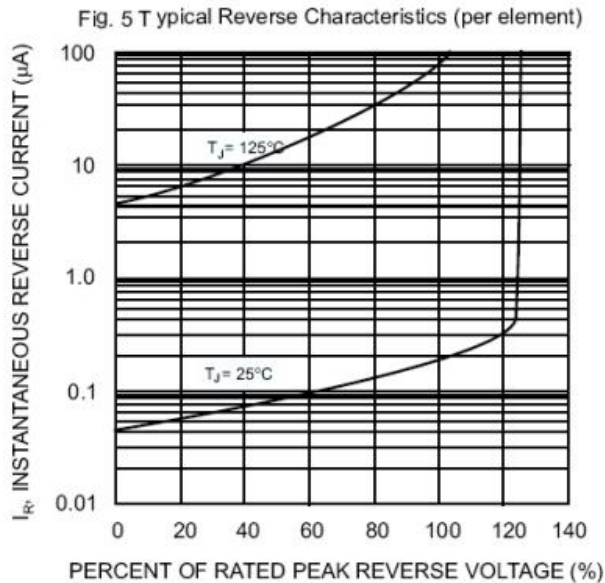
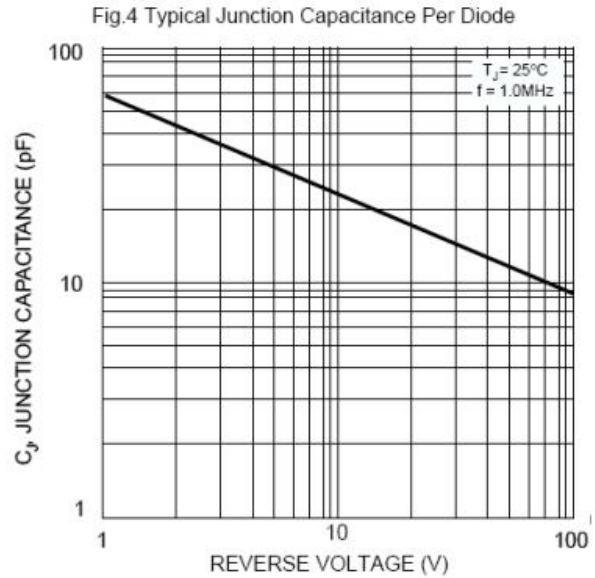
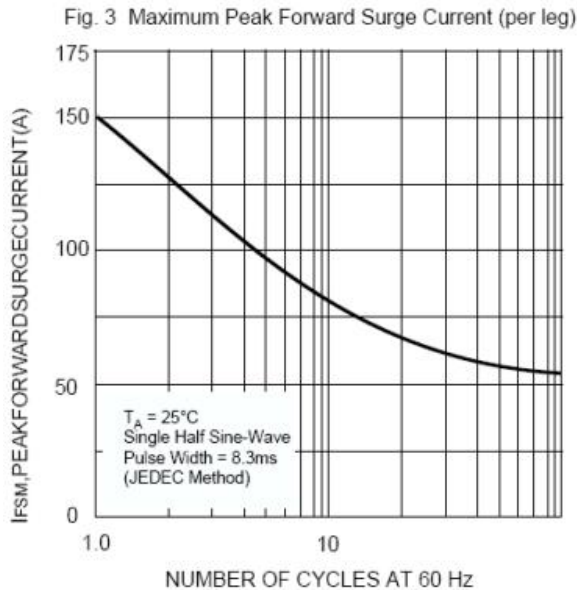

Fig. 2 Typical I Forward Characteristics (per leg)





Ordering Information

Device	Package	Plating	Shipping
UG6KB05 THRU UG6KB100	D3K(Pb-Free)	Pure Sn	37pcs / tube

For information on tape and reel specifications, including part orientation and tape sizes, please refer to our tape and reel packaging specification.

Marking Diagram

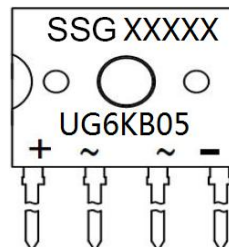

Where XXXXX is YYWWL

SSG = SSG
YY = Year
WW = Week
L = Lot Number
UG6KB05 = Type Number

Cautions: Molding resin
Epoxy resin UL:94V-0

Mechanical Dimensions D3K (Inches/Millimeters)

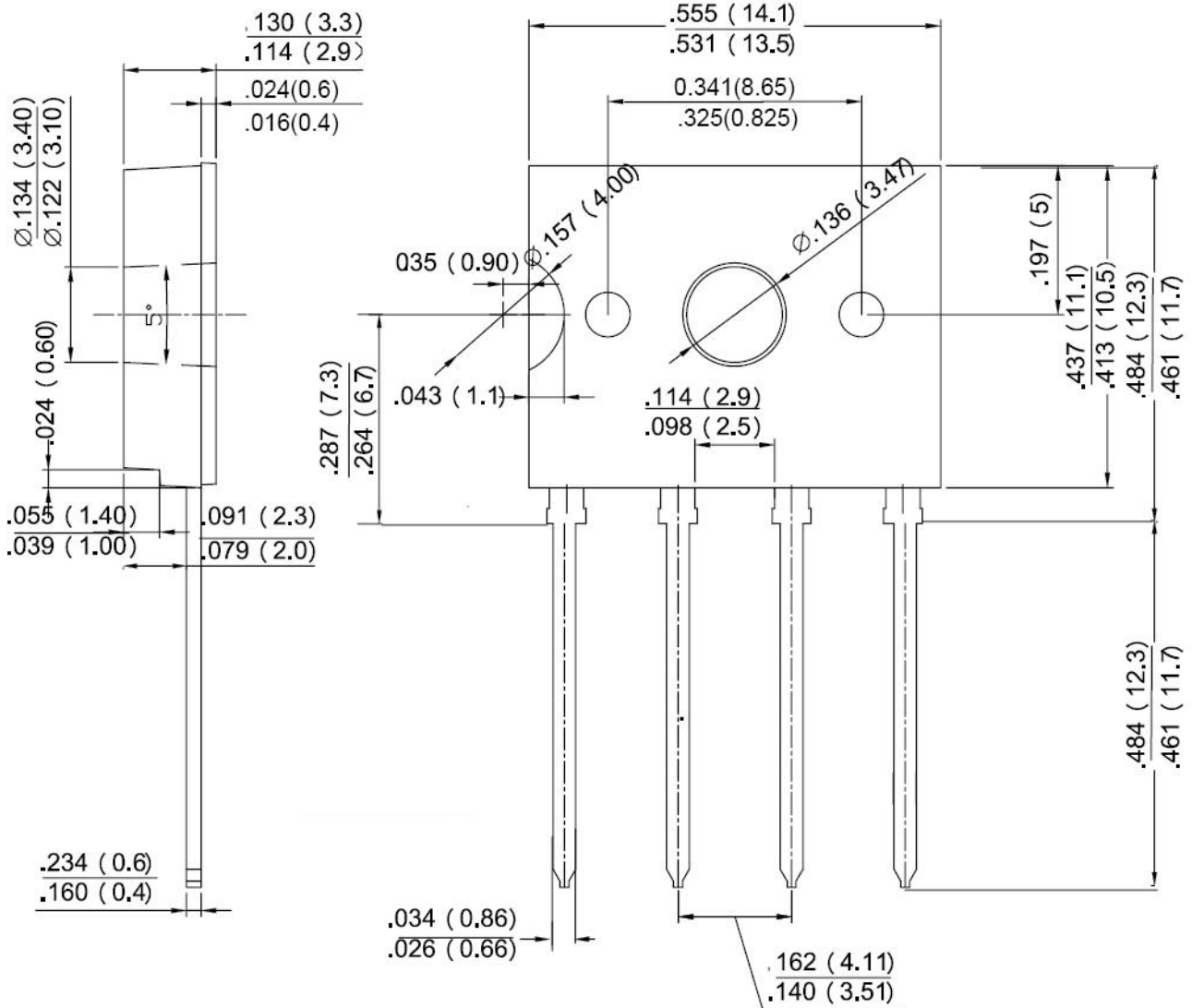

DISCLAIMER:

- 1- The information given herein, including the specifications and dimensions, is subject to change without prior notice to improve product characteristics. Before ordering, purchasers are advised to contact the SMC Diode Solutions sales department for the latest version of the datasheet(s).
- 2- In cases where extremely high reliability is required (such as use in nuclear power control, aerospace and aviation, traffic equipment, medical equipment, and safety equipment), safety should be ensured by using semiconductor devices that feature assured safety or by means of users' fail-safe precautions or other arrangement.
- 3- In no event shall SMC Diode Solutions be liable for any damages that may result from an accident or any other cause during operation of the user's units according to the datasheet(s). SMC Diode Solution assumes no responsibility for any intellectual property claims or any other problems that may result from applications of information, products or circuits described in the datasheets.
- 4- In no event shall SMC Diode Solutions be liable for any failure in a semiconductor device or any secondary damage resulting from use at a value exceeding the absolute maximum rating.
- 5- No license is granted by the datasheet(s) under any patents or other rights of any third party or SMC Diode Solutions.
- 6- The datasheet(s) may not be reproduced or duplicated, in any form, in whole or part, without the expressed written permission of SMC Diode Solutions.
- 7- The products (technologies) described in the datasheet(s) are not to be provided to any party whose purpose in their application will hinder maintenance of international peace and safety nor are they to be applied to that purpose by their direct purchasers or any third party. When exporting these products (technologies), the necessary procedures are to be taken in accordance with related laws and regulations.