

NEW

# 1.0 mm Pitch, Board-to-Wire LCD Interface Connectors

## MDF76 Series

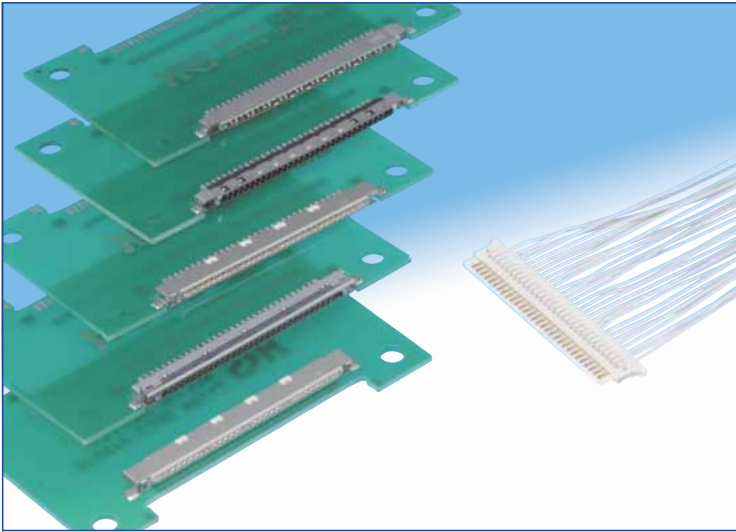

### ■ Increased Plug / Receptacle retention force

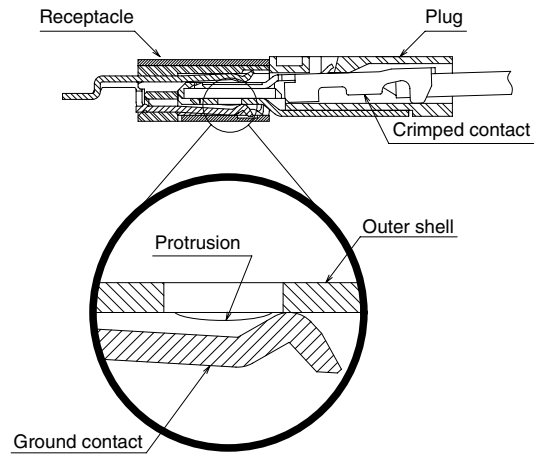

### ■ Features

#### 1. High-speed data transfer

Ground contacts opposite the signal contacts (Receptacle) provide superior impedance matching.

#### 2. EMI protection

Metal shell provides shielding and ground connections.

#### 3. Increased Plug / Receptacle retention force

Unique configuration of the receptacle ground contacts mating with the corresponding plug increases the retention force between them.

(MDF76-30P-1 Plug mated with MDF76KBW or MDF76LBRW Receptacles.)

#### 4. Incorrect insertion prevention

Built-in polarizing features prevent reverse insertion of the plug in the receptacle.

#### 5. High board retention force

Metal shell is soldered directly to the PC board.

#### 6. RoHS compliant

All components and materials comply with the requirements of EU Directive 2002/95/EC.

### ■ Applications

Notebook computers, desktop computers, Liquid Crystal Panels, LCD monitors and other devices requiring discrete wire connections with a low-profile high performance connectors.

### ■ Incorrect insertion prevention

A vertically asymmetrical key form prevents reverse insertion.

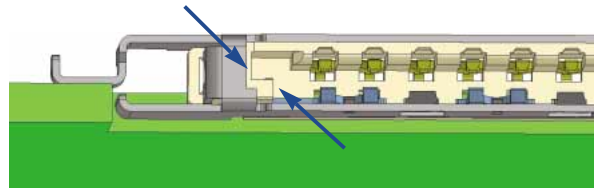

Board side receptacle

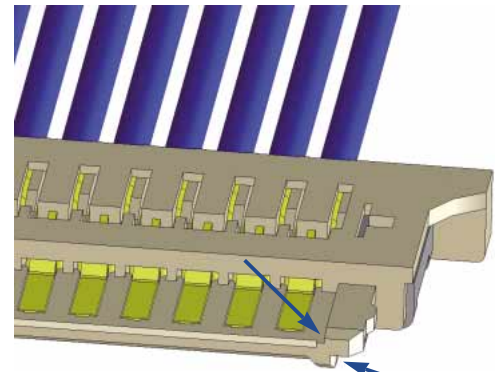

Cable side plug

## MDF76 Series 1.0 mm Pitch, Board-to-Wire LCD Interface Connectors

### Specifications

Ratings	Current rating (Note 1)	Wire size	AWG 28 to 30: 1.0 A AWG 32: 0.8 A AWG 36: 0.5 A	Operating temperature range Operating humidity range	-40°C to +85°C (Note 2) RH 20% to 80%
	Voltage rating		200 V AC	Storage temperature range Storage humidity range	-10°C to +60°C (Note 3) RH 40% to 70% (Note 3)

Item	Specification	Conditions
1. Insulation resistance	100 MΩ min.	100 V DC
2. Withstanding voltage	No flashover or insulation breakdown	500 V AC / 1 minute
3. Contact resistance	40 mΩ max.	20 mV max., at 1 mA.
4. Durability	Contact resistance: 80 mΩ max. No deformation of components affecting performance.	50 cycles
5. Vibration	No electrical discontinuity of 1 μs or longer No damage, cracks or parts dislocation.	Frequency: 10 to 55 Hz, single amplitude of 0.75 mm, 10 cycles in each of the 3 axial directions
6. Shock	No electrical discontinuity of 1 μs or longer No damage, cracks or parts dislocation.	Acceleration of 490 m/s <sup>2</sup> , 11 ms duration, sine half-wave, 3 cycles in each of the 3 axis
7. Humidity	Contact resistance: 80 mΩ max., Insulation resistance: 50 MΩ min.	96 hours at 60 ±2°C, and humidity of 90% to 95%
8. Temperature cycle	Contact resistance: 80 mΩ max., Insulation resistance: 50 MΩ min. No damage, cracks or parts dislocation.	-55°C → 5 to 35°C → 85°C → 5 to 35°C Times: 30 min. → 2 min. → 3 min. → 30 min. → 2min. to 3 min. 5 cycle
9. Resistance to soldering heat	No deformation of components affecting performance.	Reflow : At the recommended temperature profile Manual soldering : 300°C for 3 seconds

Note 1: The current rating will differ depending on the wire size used.

Note 2: Includes temperature rise caused by current flow.

Note 3: The term "storage" refers to products stored for a long period prior to mounting and use.

The operating temperature and humidity range covers the non-conducting condition of connectors after board mounting and the temporary storage conditions of transportation, etc.

### Material

#### Plug

Part	Material	Finish	Remarks
Insulator	Polyamide	Color: Beige	UL94V-0
Ground plate	Stainless steel	Tin plated	—
Crimp contact	Phosphor bronze	Gold plated	—

#### Receptacle

Part	Material	Finish	Remarks
Insulator	Polyamide or LCP (Note 4)	Color: Beige or black (Note 5)	UL94V-0
Contacts	Phosphor bronze	Gold plated	—
Ground contact	Stainless steel	Tin plated	—
Shell		Tin plated or gold plated (Note 6)	UL94V-0

Note 4: Low profile receptacles MDF76KBW and MDF76LBRW are polyamide.

High profile receptacles MDF76TW, MDF76URW, and MDF76GW are LCP.

Note 5: Low profile receptacles MDF76KBW, MDF76TW, and MDF76GW are beige.

Reverse mounting MDF76LBRW and MDF76URW are black.

Note 6: Low profile receptacles MDF76KBW and MDF76LBRW have tin plating on the solder leads.

High profile receptacles MDF76TW, MDF76URW and MDF76GW have gold plating on the solder leads.

## Ordering information

### Plug

**MDF76** # - \* P - 1 C  
 ① ② ③ ④ ⑤ ⑥

### Receptacle

**MDF76** \*\* - \* S - 1 H  
 ① ② ③ ④ ⑤ ⑥

① Series Name : MDF76	③ Number of contacts : 30
② Form type Plug Blank : Standard Receptacle (Low profile) KBW : Standard, mid-mount LBRW : Reverse, mid-mount Receptacle (High profile) TW : Standard, mid-mount URW : Reverse, mid-mount GW : Standard, top board	④ Connector type P : Plug S : Receptalce ⑤ Contact pitch : 1 mm ⑥ Housing type C : Crimp H : Right angle SMT

### Contacts

**MDF76** - 2836 PCF A  
 ① ② ③

① Applicable conductor 2836 : AWG# 28 to 36	③ Plating A : Gold plated
② Packaging PCF : Male crimp contact / reel	

**MDF76 Series 1.0 mm Pitch, Board-to-Wire LCD Interface Connectors**

**■ Plug (Discrete cable)**



- Shown terminated
- Supplied in bag. (100 pieces/bag)
- Contacts supplied separate

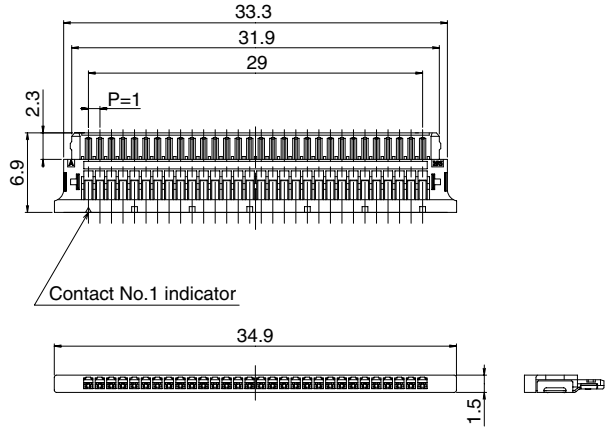

All dimensions: mm

Part Number	CL No.	Number of contacts	Insulator Color	RoHS
MDF76-30P-1C	547-0918-1	30	Beige	YES

**■ Crimp contact**

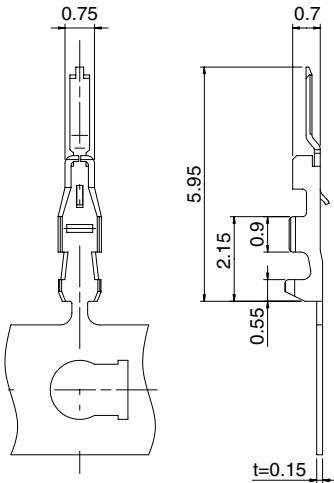

Part Number	CL No.	Packaging	Quantity	Finish	RoHS
MDF76-2836PCFA(41)	547-0919-4-41	Reel	1 Reel / 30,000	Gold plated	YES

**● Applicable wire (Tin plated annealed copper wire)**

Wire size (Stranded wire conductor)	Jacket diameter
AWG#28 (7 / 0.127mm)	0.6mm max.
AWG#30 (7 / 0.10mm)	
AWG#32 (7 / 0.08mm)	
AWG#36 (7 / 0.05mm)	0.4mm max.

Note: When using other than the recommended wire, contact nearest Hirose sales representative.

**● Tools**

Type	Part Number	CL No.
Applicator	AP105-MDF76-2836P	901-4613-1
Press	CM-105	901-0005-4
Extraction tool	DF-C-PO(B)	550-0179-2

All dimensions: mm

## ■ Receptacles (Low profile)

### ● Right angle, Standard, mid-mount, SMT

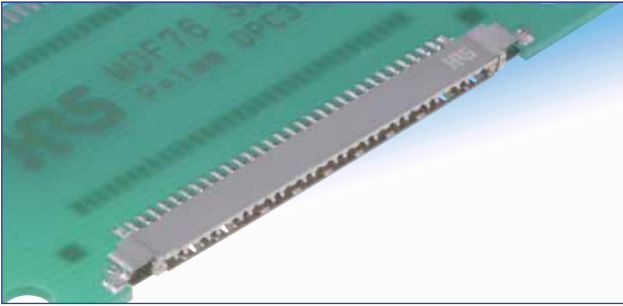

Gold plated

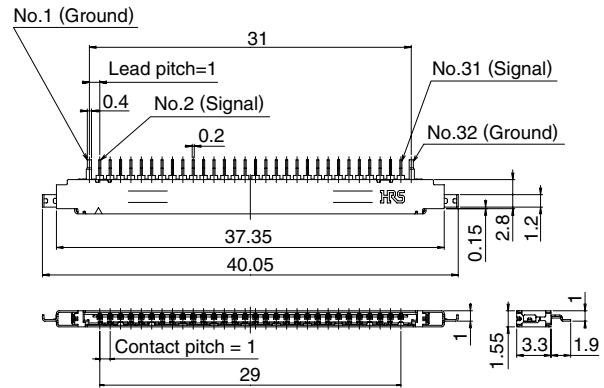

All dimensions: mm

Part Number	CL No.	Number of contacts	Insulator Color	Packaging	Above the mounting surface	RoHS
MDF76KBW-30S-1H(55)	547-0606-9-55	30	Beige	3,000 pcs. / reel	1.0 mm	YES

### ● Right angle, Reverse, mid-mount, SMT

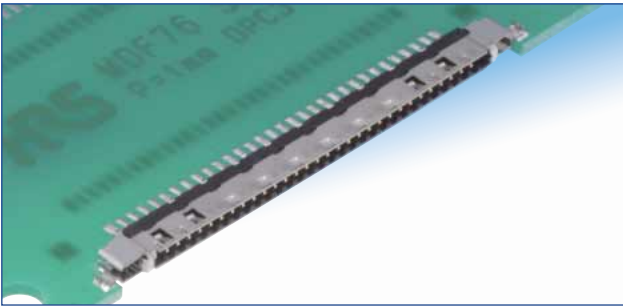

Gold plated

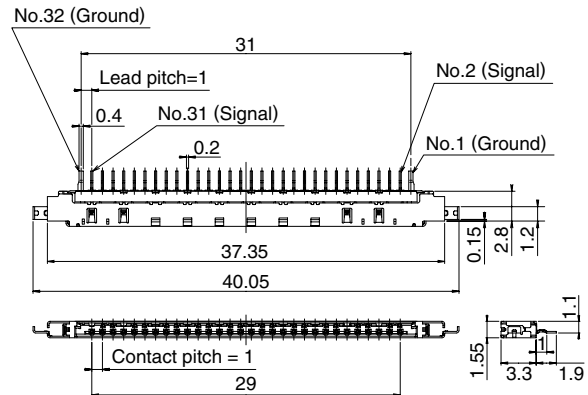

All dimensions: mm

Part Number	CL No.	Number of contacts	Insulator Color	Packaging	Above the mounting surface	RoHS
MDF76LBRW-30S-1H(55)	547-0607-1-55	30	Black	3,000 pcs. / reel	1.1 mm	YES

MDF76 Series 1.0 mm Pitch, Board-to-Wire LCD Interface Connectors

## ■ Receptacles (High profile)

### ● Right angle, Standard, mid-mount, SMT

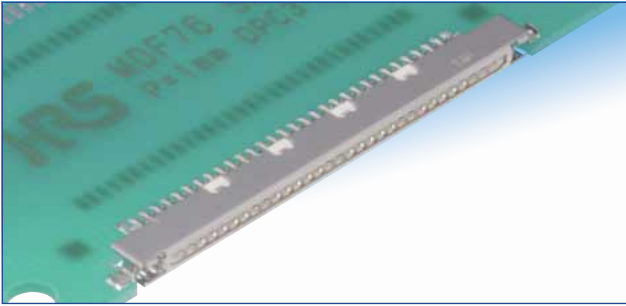

Gold plated

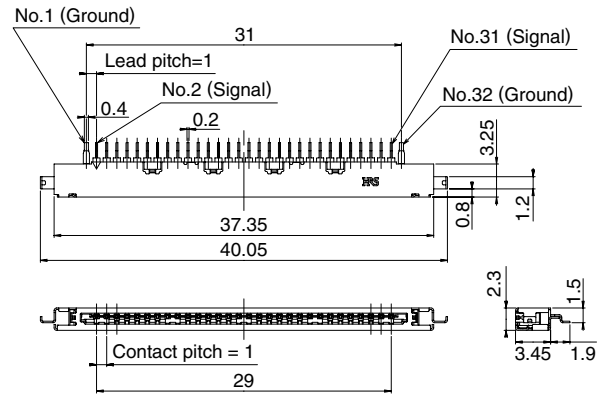

All dimensions: mm

Part Number	CL No.	Number of contacts	Insulator Color	Packaging	Above the mounting surface	RoHS
MDF76TW-30S-1H(55)	547-0912-5-55	30	Beige	2,500 pcs. / reel	1.5 mm	YES

### ● Right angle, Reverse, mid-mount, SMT

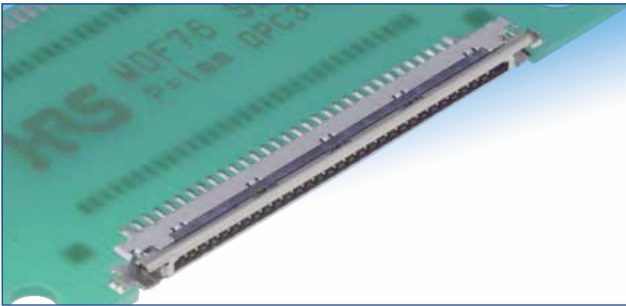

Gold plated

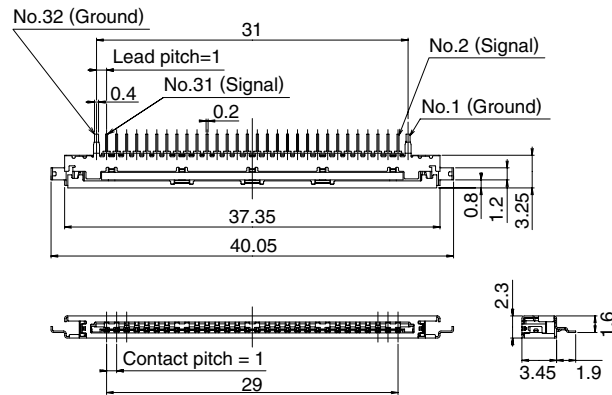

All dimensions: mm

Part Number	CL No.	Number of contacts	Insulator Color	Packaging	Above the mounting surface	RoHS
MDF76URW-30S-1H(55)	547-0913-8-55	30	Black	2,500 pcs. / reel	1.6 mm	YES







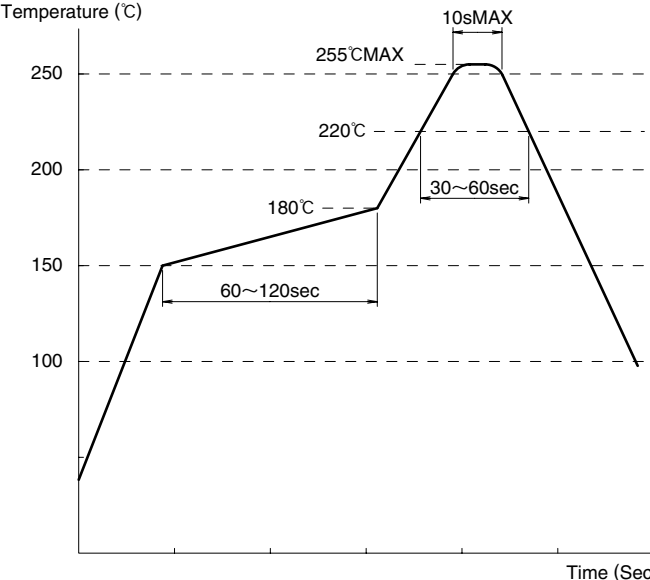
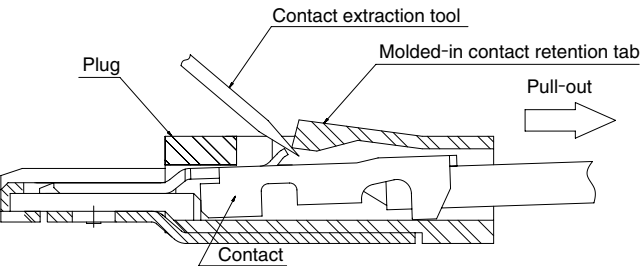

## ◆ Usage Recommendations

<p>1. Recommended temperature profile</p>	 <p>Note 1: Up to 2 cycles of Reflow soldering is possible under the same conditions, provided that there is a return to normal temperature between the first and second cycle.</p> <p>Note 2: The temperature profile indicates the board surface temperature at the point of contacts with the connector terminals.</p>
<p>2. Recommended manual soldering</p>	<p>300±10°C for 3 seconds</p>
<p>3. Recommended screen thickness and open area ratio</p>	<p>Thickness: 0.15 mm Open area ratio: 100%</p>
<p>4. Board warpage</p>	<p>Maximum of 0.03 mm at the connector center, with both ends of the connector as reference points.</p>
<p>5. Cleaning conditions</p>	<p>Refer to "Nylon Connector Use Handbook".</p>
<p>6. Wire preparation and contact crimping</p>	<p>Refer to "Nylon Connector Use Handbook". The crimp contact termination must be performed using specified tools. All dimensions and crimp conditions are listed in applicable Crimp Condition Table and Crimping Quality Standards Manual.</p>
<p>7. Crimped contact extraction</p>	<p>■ Insert the contact retention tool in the insulator body and carefully lift the molded-in retention tab while pulling on the wire at the same time (Fig. 1). Do not deflect the molded-in retention tab more than is needed to release the contact. The tab should return to its initial position after the contact is removed.</p> <p>Note: If the tab is not returning to it's initial position carefully push it back before inserting the crimped contact. Permanent breakage of the molded-in retention tab will require replacement of the entire plug.</p>  <p><b>Figure 1. Contact Extraction</b></p>

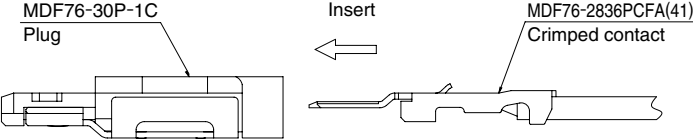
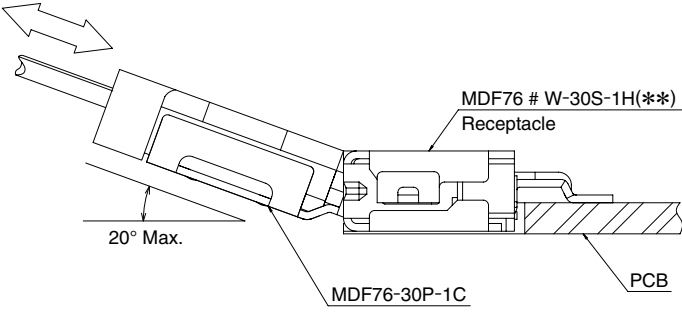
<p>8.Crimped contact insertion</p>	<p>Contact must be inserted horizontally oriented as shown on Fig. 2                  Do NOT attempt to insert crimped contact in any other direction.</p> <div style="border: 1px solid black; padding: 5px; width: fit-content; margin: 10px auto;">Horizontal insertion !</div>  <p style="text-align: center;"><b>Figure 2. Crimped Contact Insertion</b></p>
<p>9.Connector mating / unmating</p>	<p>Mating / unmating of the connectors should be done in the direction parallel to the receptacle's mounting surface. Do not attempt to mate/unmate in any other direction.                  Note: The connectors will self-guide themselves within the 20° angle, as shown in Fig. 3.</p>  <p style="text-align: center;"><b>Figure 3. Angular mating / unmating</b></p>
<p>10.Precautions</p>	<p>Do not mate / unmate the connectors when the receptacle is NOT mounted on the PC board.                  Differences in color shade of molded components will not affect form, fit or function.                  Contact HRS if additional information is required.</p>



## MDF76 Series 1.0 mm Pitch, Board-to-Wire LCD Interface Connectors

### USA:

#### HIROSE ELECTRIC (U.S.A.), INC. Headquarters

2688 Westhills Court, Simi Valley, CA 93065-6235  
Phone : 1-805-522-7958  
Fax : 1-805-522-3217  
<http://www.hiroseusa.com>

### USA:

#### HIROSE ELECTRIC (U.S.A.), INC. North California Office

20400 Stevens Creek Blvd., Ste 250, Cupertino, CA 95014  
Phone : 1-408-253-9640  
Fax : 1-408-253-9641  
<http://www.hiroseusa.com>

### USA:

#### HIROSE ELECTRIC (U.S.A.), INC. Dallas Office

1701 N. Greenville Ave. Ste 817, Richardson, TX 75081  
Phone : 1-469-330-9200  
Fax : 1-469-330-9205  
<http://www.hiroseusa.com>

### USA:

#### HIROSE ELECTRIC (U.S.A.), INC. Chicago Office

2777 Finley Road, Suite 28 Downers Grove, IL 60148  
Phone : 1-630-916-1455  
Fax : 1-630-916-1451  
<http://www.hiroseusa.com>

### USA:

#### HIROSE ELECTRIC (U.S.A.), INC. New York Office

510 Broadhollow Road, Suite 305, Melville, NY 11747  
Phone : 1-516-249-5259  
<http://www.hiroseusa.com>

### USA:

#### HIROSE ELECTRIC (U.S.A.), INC. Detroit Office (Automotive)

37650 Professional Center Drive, Suite 120A, Livonia, MI 48154  
Phone : 1-734-542-9963  
Fax : 1-734-542-9964  
<http://www.hiroseusa.com>

### GERMANY:

#### HIROSE ELECTRIC GmbH

Herzog-Carl-Strasse 4 D-73760 Ostfildern (Scharnhäuser Park)  
Phone : 49-711-4560-02-1  
Fax : 49-711-4560-02-299  
<http://www.hirose.de>

### THE NETHERLANDS:

#### HIROSE ELECTRIC EUROPE B.V.

Beechavenue 46,1119 PV Schiphol-Rijk  
Phone : 31-20-6557490  
Fax : 31-20-6557469  
<http://www.hiroseeurope.com>

### FINLAND:

#### Hirose Electric Europe B.V. Finland Office

Teknobulevardi 3-5 01530 VANTAA  
Phone : 358-9-2517-8459  
Fax : 358-9-2517-8460  
<http://www.hiroseeurope.com>

### UNITED KINGDOM:

#### HIROSE ELECTRIC UK LTD.

Crownhill Business Centre 22 Vincent Avenue Crownhill, Milton Keynes MK8 OAB  
Phone : 44-1908-305400  
Fax : 44-1908-305401  
<http://www.hirose.co.uk>

### CHINA:

#### HIROSE ELECTRIC CO., LTD. Beijing Office

Unit 1605, Block A, ZhuBang2000 BusinessCenter, No.100, Balizhuang Xili, Chaoyang District, Beijing, 10025  
Phone : 86-10-5165-9332  
Fax : 86-10-8586-1418  
<http://www.hirose-china.com.cn>

### CHINA:

#### HIROSE ELECTRIC (SHANGHAI) CO., LTD.

1501-02, Cross Tower Building 318 Fuzhou Road, Huang Pu District Shanghai, 200001  
Phone : 86-21-6391-3355  
Fax : 86-21-6391-3335  
<http://www.hirose-china.com.cn>

### CHINA:

#### HIROSE ELECTRIC CO., LTD. Shenzhen Office

Room 1902-05, Office Tower Shun Hing Square, DiWang Commercial Centre 5002 ShenNanDong Road, ShenZhen  
Phone : 86-755-8207-0851  
Fax : 86-755-8207-0873  
<http://www.hirose-china.com.cn>

### HONG KONG:

#### HIROSE ELECTRIC CO., LTD.

Unit 1102, Energy Plaza, 92 Granville Road, Tsim Sha Tsui East, Kowloon  
Phone : 852-2803-5338  
Fax : 852-2591-6560  
<http://www.hirose-hongkong.com.hk>

### TAIWAN:

#### HIROSE ELECTRIC TAIWAN CO., LTD.

No.28 Lane 247 Sec. 2 Yen Ping N,Rd.Taipei  
Phone : 886-2-2557-7351,7352  
Fax : 886-2-2552-9851  
<http://www.hirose-taiwan.com.tw>

### SINGAPORE:

#### HIROSE ELECTRIC CO., LTD.

10 Anson Road #26-16 International Plaza 079903  
Phone : 65-6324-6113  
Fax : 65-6324-6123  
<http://www.hirose-singapore.com.sg>

### KOREA:

#### HIROSE KOREA CO., LTD.

(#2NA311,Shihwa Industrial Complex),1261-10, Jeungwhang-Dong, Shihung-City, Kyunggi-Do 429-450  
Phone : 82-31-496-7000,7124  
Fax : 82-31-496-7100  
<http://www.hirose.co.kr>



# HRS

## HIROSE ELECTRIC CO.,LTD.

5-23,OSAKI 5-CHOME,SHINAGAWA-KU,TOKYO 141-8587,JAPAN  
PHONE: 81-3-3491-9741, FAX: 81-3-3493-2933  
<http://www.hirose.com>  
<http://www.hirose-connectors.com>