

IEC Appliance Inlet C14 with Filter, Fuseholder 1- or 2-pole (5x20 mm or 6.3x32 mm), Line Switch 1- or 2-pole, Voltage Selector (Step)

Standard- or Medical-Filter



V-Lock



Description

- Panel Mount :
Screw-on mounting from front side
- 5 Functions :
Appliance Inlet , Line Switch , Fuseholder with interchangeable fuse drawer for Fuse-links 5x20 mm or 6.3x32 mm , with or without voltage selector (step switch) , Line filter in standard and medical version
- Quick connect terminals 4.8 x 0.8 mm

Unique Selling Proposition

- Multifunctional Power Entry Module
- Solid metal flange
- Various fuse drawers
- Slim design

Approvals

- VDE Certificate Number: 40004665 (FKSO, FKSP, FKSU, FKSV)
- UL File Number: E72928 (FKSO, FKSP, FKSU, FKSV)

Characteristics

- All single elements are already wired
- The fuse drawer "Fingergrip" can be removed by hand
- Suitable for use in equipment according to IEC/UL 60950
- Suitable for use in medical equipment according to IEC/UL 60601-1

References

Alternative: version without line filter [KD](#)
Alternative: Standard version

Weblinks

[pdf datasheet](#), [html-datasheet](#), [General Product Information](#), [RoHS](#), [CHINA-RoHS](#), [REACH](#), [Distributor-Stock-Check](#), [Accessories](#), [Detailed request for product](#)

Newly available variants corresponding to V-Lock mating cordset. The connector is equipped with a notch intended for use with the latching cordset. The cord latching system prevents against accidental removal of the cordset.

Technical Data

Ratings IEC	1 - 10A @ Ta 40 °C / 250 VAC; 50Hz	appliance inlet/-outlet	C14 acc. to IEC 60320-1, UL 498, CSA C22.2 no. 42 (for cold conditions) pin-temperature 70 °C, 10A, Protection Class I
Ratings UL/CSA	1 - 10A @ Ta 40 °C / 125 VAC; 60Hz	Fuseholder	1 or 2 pole, Shocksafe category PC2 acc. to IEC 60127-6, for fuse-links 5 x 20 or 6.3 x 32 mm
Leakage Current	standard < 0.5 mA (250 V / 60Hz) medical < 5 µA (250 V / 60 Hz)	Rated Power Acceptance @ Ta 23 °C	5 x 20: 2.5W (1 pole)/ 2W (2-pole) per pole 6.3 x 32: 3.15W (1 pole)/ 2.5W (2-pole) per pole
Dielectric Strength	> 1.7 kVDC between L-N > 2.7 kVDC between L/N-PE Test voltage (2 sec)	Power Acceptance @ Ta > 23°C	Admissible power acceptance at higher ambient temperature see derating curves
Allowable Operation Temperature	-25 °C to 85 °C	Line Switch	2-pole, non-illuminated, acc. to IEC 61058-1 Technical Details
Climatic Category	25/085/21 acc. to IEC 60068-1	Voltage Selector	optional, step, 2-4 digits
IP-Protection	from front side IP 40 acc. to IEC 60529	Line Filter	Standard and Medical Version, IEC 60939, UL 1283, CSA C22.2 no. 8 Technical Details
Protection Class	Suitable for appliances with protection class I acc. to IEC 61140	MTBF	> 1'200'000h acc. to MIL-HB-217 F
Terminal	Quick connect terminals 4.8 x 0.8 mm		
Panel Thickness s	Screw: max 8 mm Mounting screw torque max 0.5Nm		
Material: Housing	Thermoplastic, black, UL 94V-0		

Detailed information on product approvals, code requirements, usage instructions and detailed test conditions can be looked up in [General Product Information](#)

Dimension
CD

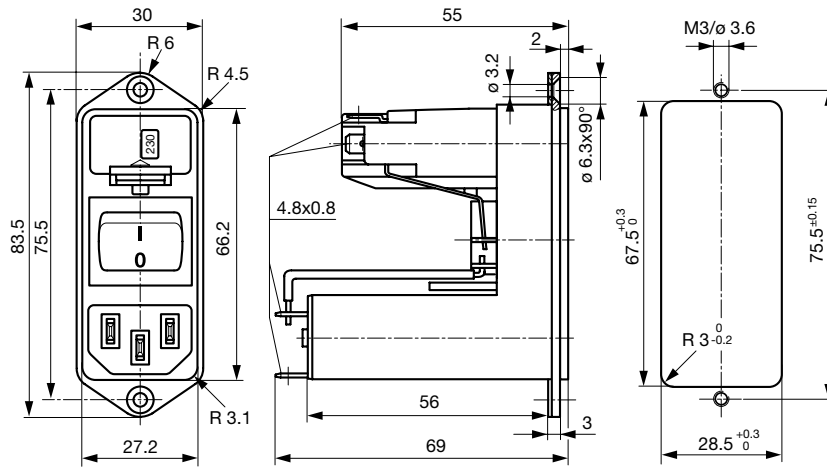

Technical Data of Filter-Components

Rated Current [A]	Filter-Type	Inductances L [mH]	Capacitance CX [nF]	Capacitance CY [nF]	R [MΩ]
1	Standard Version	2 x 10	68	2.2	-
2	Standard Version	2 x 4	68	2.2	-
4	Standard Version	2 x 1.5	68	2.2	-
6	Standard Version	2 x 0.8	68	2.2	-
10	Standard Version	2 x 0.3	68	2.2	-
1	Medical Version (M5)	2 x 10	68	-	1
2	Medical Version (M5)	2 x 4	68	-	1
4	Medical Version (M5)	2 x 1.5	68	-	1
6	Medical Version (M5)	2 x 0.8	68	-	1
10	Medical Version (M5)	2 x 0.3	68	-	1
2	Medical (M80)	2 x 4	68	0.47	1
4	Medical (M80)	2 x 1.5	68	0.47	1
10	Medical (M80)	2 x 0.3	68	0.47	1

Diagrams

Standard version with voltage selector

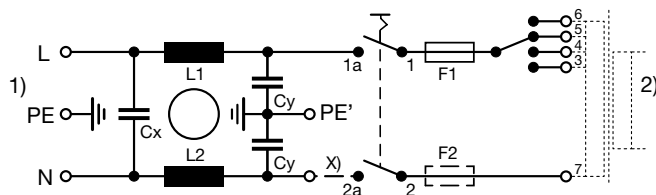

- 1) Line
- 2) Load
- x) External connection to be made by the customer

Medical version with voltage selector

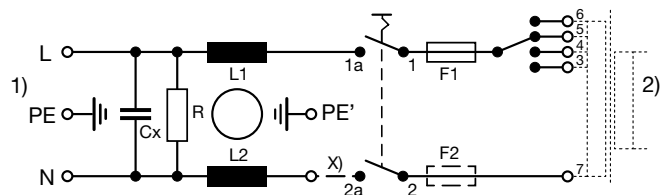

- 1) Line
- 2) Load
- x) External connection to be made by the customer

Derating Curves

Fuses

5 x 20 mm (1-pole)

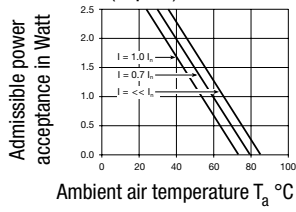

Fuses

5 x 20 mm (2-pole, per pole)

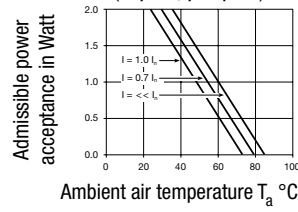

Fuses

6.3 x 32 mm (1-pole)

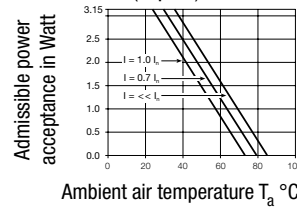

Fuses

6.3 x 32 mm (2-pole, per pole)

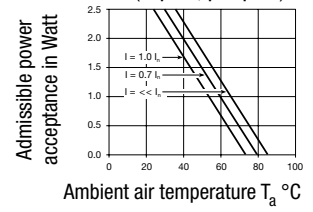

Attenuation Loss

Standard version

--- 50Ω differential mode — 50Ω common mode

1 A

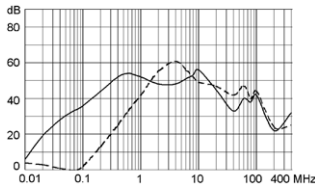

2 A

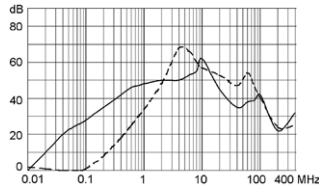

4 A

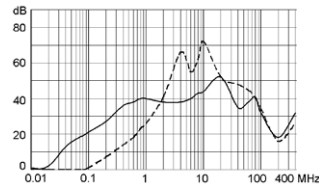

6 A

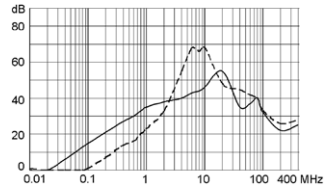

10 A

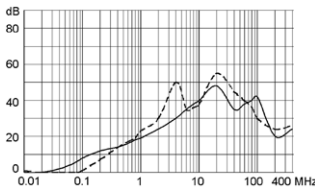

Medical version (M5)

1 A

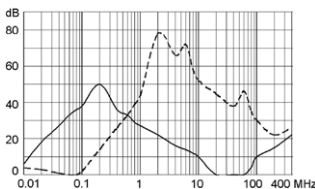

2 A

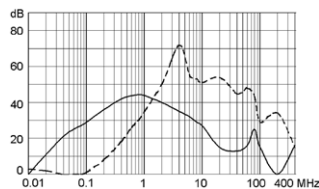

4 A

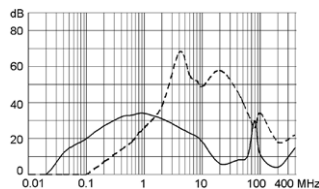

6 A

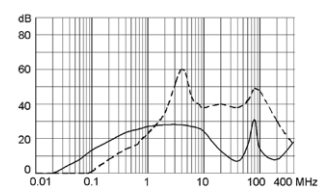

10 A

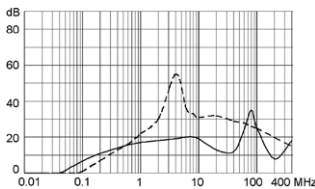

All Variants

Type	Rated Current [A]	Filter-Type	Fuseholder	Line Switch	Voltage Selector	V-Lock	Order Number
CD	1	Standard Version	1-pole	2-pole	-		CD11.1501.151
CD	2	Standard Version	1-pole	2-pole	-		CD21.1501.151
CD	4	Standard Version	1-pole	2-pole	-		CD31.1501.151
CD	6	Standard Version	1-pole	2-pole	-		CD41.1501.151

Type	Rated Current [A]	Filter-Type	Fuseholder	Line Switch	Voltage Selector	V-Lock	Order Number
CD	10	Standard Version	1-pole	2-pole	-		CD61.1501.151
CD	1	Standard Version	1-pole	2-pole	2-4 digits		CD11.4501.151
CD	2	Standard Version	1-pole	2-pole	2-4 digits		CD21.4501.151
CD	4	Standard Version	1-pole	2-pole	2-4 digits		CD31.4501.151
CD	6	Standard Version	1-pole	2-pole	2-4 digits		CD41.4501.151
CD	10	Standard Version	1-pole	2-pole	2-4 digits		CD61.4501.151
CD	1	Standard Version	2-pole	2-pole	-		CD14.1101.151
CD	2	Standard Version	2-pole	2-pole	-		CD24.1101.151
CD	4	Standard Version	2-pole	2-pole	-		CD34.1101.151
CD	6	Standard Version	2-pole	2-pole	-		CD44.1101.151
CD	10	Standard Version	2-pole	2-pole	-		CD64.1101.151
CD	1	Standard Version	2-pole	2-pole	2-4 digits		CD14.4101.151
CD	2	Standard Version	2-pole	2-pole	2-4 digits		CD24.4101.151
CD	4	Standard Version	2-pole	2-pole	2-4 digits		CD34.4101.151
CD	6	Standard Version	2-pole	2-pole	2-4 digits		CD44.4101.151
CD	10	Standard Version	2-pole	2-pole	2-4 digits		CD64.4101.151
CD	6	Medical Version (M5)	2-pole	2-pole	-		CDE4.1101.151
CD	1	Medical Version (M5)	2-pole	2-pole	2-4 digits		CDG4.4101.151
CD	2	Medical Version (M5)	2-pole	2-pole	2-4 digits		CDA4.4101.151
CD	4	Medical Version (M5)	2-pole	2-pole	2-4 digits		CDC4.4101.151
CD	6	Medical Version (M5)	2-pole	2-pole	2-4 digits		CDE4.4101.151
CD	6	Medical Version (M5)	2-pole	2-pole	2-4 digits	●	CDE4.4101.151.21
CD	10	Medical Version (M5)	2-pole	2-pole	2-4 digits		CDL4.4101.151
CD	2	Medical (M80)	2-pole	2-pole	2-4 digits		CDB4.4101.151
CD	4	Medical (M80)	2-pole	2-pole	2-4 digits		CDD4.4101.151
CD	10	Medical (M80)	2-pole	2-pole	2-4 digits		CDM4.4101.151
CD	10	Medical (M80)	2-pole	2-pole	2-4 digits	●	CDM4.4101.151.21

Most Popular.

Availability for all products can be searched real-time: <http://www.schurter.com/en/Stock-Check/Stock-Check-SCHURTER>

Packaging unit 10 Pcs

Required Accessory

Description

Fusedrawer 3
Fusedrawer for Fuse Links 5x20 mm resp. 6.3x32 mm



Fingergrip, 5 x 20, 2-pole, Voltage Selector	4303.2014.00
Fingergrip, 5 x 20, 2-pole, Voltage Selector, 100, 120, 220, 240	4303.2014.01
Fingergrip, 5 x 20, 2-pole, Voltage Selector, 110, 150, 220	4303.2014.02
Fingergrip, 5 x 20, 2-pole, Voltage Selector, 110, 220	4303.2014.03

...

Accessories



Wire Harness
Wire harness for SCHURTER products



Assorted Covers
Rear Cover

0859.0077



Cord retaining kits
Cord retaining strain relief

Flat head, A

4700.0001

Mating Outlets/Connectors

Category / Description

Appliance Outlet Overview complete



IEC Appliance Outlet F, Screw-on Mounting, Front Side, Solder Terminal	4787
IEC Appliance Outlet F, Snap-in Mounting, Front Side, Solder or Quick-connect Terminal	4788
IEC Appliance Outlet F or H, Screw-on Mounting, Front Side, Solder, PCB or Quick-connect Terminal	5091

Appliance Outlet further types to CD

Connector Overview complete



4782 Mounting: Power Cord, 3 x 1 mm ² / 3 x 18 AWG, Cable, Connector: IEC C13	4782
4022 Mounting: Power Supply Cord, 3 x 1.5 mm ² , Screw clamps, Connector: IEC C13	4022
4785 Mounting: Power Cord, 3 x 1 mm ² / 3 x 18 AWG, Cable, Connector: IEC C13	4785
4300-06 Mounting: Power Cord, 3 x 1 mm ² / 3 x 18 AWG, Cable, Connector: IEC C13	4300-06
4012 Mounting: Power Supply Cord, 3 x 1.5 mm ² , Screw clamps, Connector: IEC C13	4012

Connector further types to CD

...

Mating Outlets/Connectors shuttered



Power Cord Overview complete

VAC13KS, Overview, diverse Connector IEC C13, cord end:	VAC13KS
---	---------

Power Cord further types to CD